

Furniture & cabinets
Meble i szafki

345-367



Furniture

Meble.....	345
Roller cabinets with tools insert	
Szafki serwisowe z narzędziami.....	348
Tool cabinets	
Szafki serwisowe.....	354
Workbenches	
Stoły warsztatowe.....	357
Tools in PVC trays	
Zestawy narzędzi do szuflad.....	357
Accessories for tool cabinets & workbenches	
Akcesoria do szafek i stołów.....	357

Hermetic tool boxes
Walizki narzędziowe hermetyczne

367-368



Tool boxes
Skrzynki narzędziowe

368-369



Lubrication system tools
Narzędzia do obsługi układu smarowania

370-376



Oil filter wrenches & sets	
Klucze do filtra oleju i zestawy.....	370
Oil drain plug sockets	
Klucze do spustu oleju.....	372
Grease guns & accessories	
Smarownice ręczne i akcesoria.....	373
Oil cans	
Oliwiarki.....	376
Oil and fuel pumps	
Pompy do oleju oraz paliwa.....	376

Pullers
Ściągacze

377-392



Pullers	
Ściągacze.....	377
Roller stud extractor sets	
Zestawy ściągaczy do szpilek.....	385
Upholstery removers	
Ściągacze do tapicerki.....	391

Car window tools
Narzędzia do szyb samochodowych

392



Special pullers
Ściągacze specjalistyczne

392-394



Air condition tools
Narzędzia do klimatyzacji

394



Fuel feel pipe pliers
Szczypce motoryzacyjne

395-399



Engine repair tools
Narzędzia do obsługi silnika

400-432



Piston ring compressors	
Zaciskacze do pierścieni.....	400
Honing machines & accessories	
Honownice i akcesoria.....	400
Engine repair and diagnostic tools	
Narzędzia do diagnostyki i naprawy silników.....	402

Brake system tools
Narzędzia do obsługi układu hamulcowego

433-440



Suspension system tools
Narzędzia do obsługi podwozia

440-445



Spring clamps & accessories	
Ściągacze do sprężyn i akcesoria.....	440
Shock absorber nut sets	
Zestawy nasadek do amortyzatorów.....	441
Tire valve stem inserter	
Przeciągacze do zaworów gumowych.....	441
Wheel balance pliers	
Szczypce do wyważania kół.....	442
Deep thin wall impact sockets	
Udarowe klucze nasadowe do felg aluminiowych.....	442
Wheel wrenches	
Klucze do kół.....	443
Impact wrenches	
Klucze udarowe.....	444
Tire levers	
Łyżki do opon.....	445

Workshop tools
Narzędzia warsztatowe

445-455



Inspection tools	
Narzędzia inspekcyjne.....	445
Magnetic pick up tools	
Chwytki magnetyczne.....	445
Magnetic trays	
Tacki magnetyczne.....	446
Workshop seats	
Taborety warsztatowe.....	448
Workshop creepers	
Leżanki warsztatowe.....	448
Workshop mats	
Maty warsztatowe.....	448
Voltage testers	
Próbniki napięcia.....	449
Tapes	
Taśmy.....	449
Number & letter stamps	
Znaczniki cyfrowe i literowe.....	449
Thread repair sets & accessories	
Zestawy do naprawy gwintów i akcesoria.....	449
Pressure gauges	
Wskaźniki ciśnienia.....	452



Pumps	
Pompki.....	452
Compressors	
Kompresory.....	453
Air wedges	
Poduszki montażowe.....	455
Tire racks	
Stojaki na koła.....	455

Funnels, oil drainer & drainer pans		
Lejki, miski i zlewarki do oleju	455-457	

Bottle & floor jacks		
Dźwigniki słupkowe i podnośniki	458-459	

Vehicle ramps & jack stands		
Najazdy i podstawki pod samochód	460	

Porta power kits		
Rozpieraki hydrauliczne	460-461	

Battery chargers, jump starters, power inverters & battery testers		
Prostowniki, urządzenia rozruchowe, przetwornice napięcia i testery akumulatorów	461-465	

Refractometers		
Refraktometry	465	

Workshop cable reels		
Przedłużacze warsztatowe	466	

Workshop equipment		
Sprzęt warsztatowy	466-469	

Chain blocks		
Wciągarki łańcuchowe.....	466	
Lever blocks		
Wciągarki łańcuchowe dźwigniowe.....	466	
Hand pullers		
Wciągarki linowe, ręczne.....	466	
Transmission jacks		
Podnośniki skrzyni biegów.....	467	
Parts washers		
Mijki warsztatowe.....	467	
Sandblaster cabinets & accessories		
Piaskarki kabinowe i akcesoria.....	467	
Shop cranes & shop presses		
Żurawie i prasy warsztatowe.....	468	

Workshop standardized parts		
Normalia motoryzacyjne	470-486	

CREATE YOUR WORKPLACE - STWÓRZ SWOJE MIEJSCE PRACY



YT-08931
High workshop cabinet
Szafka warsztatowa wysoka

YT-08935
Wall cabinet
Szafka podwieszana

YT-08936
Hook panel
Panel perforowany

YT-08938
YT-08939
Worktop
Blat roboczy

YT-08934
Workshop cabinet
Szafka warsztatowa

YT-08933
Workshop cabinet
Szafka warsztatowa

- EN High workshop cabinet
- PL Szafka warsztatowa wysoka
- DE Hoher Werkstattschrank
- RU Шкаф для мастерской, высокий
- CZ Skříňka pro ukládání nástrojů
- HU Szekrény szerszámok tárolására
- RO Dulap depozitare
- FR Armoire de rangement
- IT Armadio da officina alto
- ES Gabinete de almacenamiento
- CN 高柜



660x457
x2000
mm

x3
SHELVES
POŁKI

ADJUSTABLE
FEET
REGULOWANE
STOPY

2x 



- EN Working cabinet
- PL Szafka warsztatowa
- DE Werkzeugkasten
- RU Портативный ящик для инструментов
- CZ Přenosná skříňka na nářadí
- HU Hordozható szerszámok láda
- RO Dulap pt. scule
- FR Servante d'atelier
- IT Banco da lavoro armadio
- ES Cajonera portátil
- CN 工具柜



660x457
x863
mm

4x 

ADJUSTABLE
FEET
REGULOWANE
STOPY

BALL
BEARINGS
ŁOŻYSKA
KULKOWE

2x 



Drawer quantity / Liczba szuflad



YT-08933

4

1

- EN Working cabinet
- PL Szafka warsztatowa
- DE Werkzeugkasten
- RU Портативный ящик для инструментов
- CZ Přenosná skříňka na nářadí
- HU Hordozható szerszámok láda
- RO Dulap pt. scule
- FR Servante d'atelier
- IT Banco da lavoro armadio
- ES Cajonera portátil
- CN 双门矮柜



660x457
x863
mm

SHELF
POŁKA

ADJUSTABLE
FEET
REGULOWANE
STOPY

2x 



YT-08931



1



YT-08934



1

EN Wall cabinet
 PL Szafka podwieszana
 DE Hängeschrank
 RU Настенный инструментальный шкаф
 CZ Nástěnná skříň
 HU Fall szekrény
 RO Dulap de perete
 FR Armoire murale
 IT Armadio sospeso
 ES Gabinete de pared
 CN 小墙柜

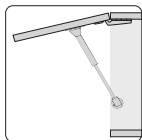

YT-08935



1

EN Worktop
 PL Blat roboczy
 DE Werkstatt Tischplatte
 RU Столешница для мастерской
 CZ Pracovní deska
 HU Munkalap
 RO Blat de lucru
 FR Plan de travail
 IT Piano di lavoro
 ES Encimera
 CN 木质工作台面



YT-08938



1

EN Strengthening element
 PL Wzmocnienie blatu
 DE Verstärkungselement
 RU Укрепление столешницы
 CZ Podpůrný prvek
 HU Asztali támogatás
 RO Tabla
 FR Support de table
 IT Rinforzo del piano di lavoro
 ES Soporte de mesa
 CN 工作台挂板



For YT-08939
 Dla YT-08939



YT-08940



5

EN Shelf
 PL Półka
 DE Regal
 RU Полка
 CZ Półka
 HU Polc
 RO Raft
 FR Étagère
 IT Scaffale
 ES Estante
 CN 层板



For YT-08931, YT-08934
 Dla YT-08931, YT-08934



YT-08932



5

EN Worktop
 PL Blat roboczy
 DE Werkstatt Tischplatte
 RU Столешница для мастерской
 CZ Pracovní deska
 HU Munkalap
 RO Blat de lucru
 FR Plan de travail
 IT Piano di lavoro
 ES Encimera
 CN 木质工作台面



YT-08939



1

EN Hook panel
 PL Panel perforowany
 DE Perforierte Wand
 RU Стенка с перфорацией
 CZ Děrovaná stěna
 HU Perforált fal
 RO Perete perforat
 FR Mur perforé
 IT Pannello forato
 ES Pared perforada
 CN 网孔板

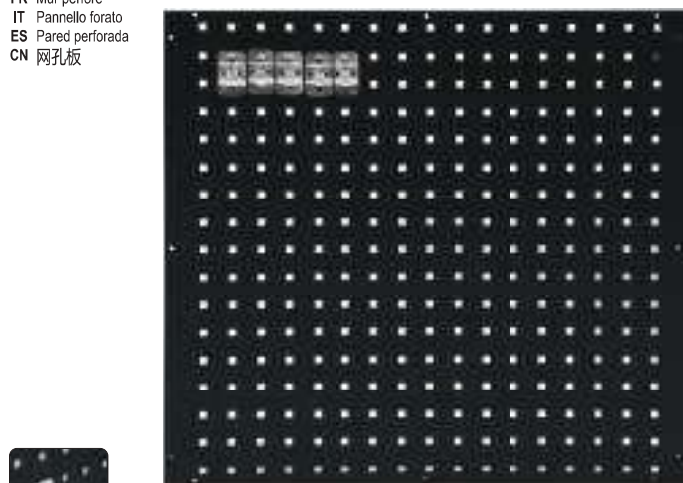

YT-08936



1

- EN Hook panel support
PL Stelaz do paneli perforowanych
DE Verstärkungselement Perforierte Wand
RU Каркас для стенки с перфорацией
CZ Podpůrný prvek děrovaná stěna
HU Asztali támogatás perforált fal
RO Cadru de metal
FR Panneaux muraux perforés pour le soutien
IT Telaio per pannelli forati
ES Paneles de pared perforados de soporte
CN 工具柜



For YT-08936 x 3
Dla YT-08936 x 3

YATO 	
YT-08941	1

- EN Hook panel support
PL Stelaz do paneli perforowanych
DE Verstärkungselement Perforierte Wand
RU Каркас для стенки с перфорацией
CZ Podpůrný prvek děrovaná stěna
HU Asztali támogatás perforált fal
RO Cadru de metal
FR Panneaux muraux perforés pour le soutien
IT Telaio per pannelli forati
ES Paneles de pared perforados de soporte
CN 工具柜



For YT-08936 x 2
Dla YT-08936 x 2

YATO 	
YT-08942	1



- EN Power tool holder
PL Półka na elektronarzędzia
DE Elektrowerkzeug-Aufbewahrungshalterung
RU Полка для шуруповертов
CZ Držák závěsný na elektrické nářadí
HU Elektromos szerszámtartó
RO Suport scule electrice
FR Support pour outils électriques
IT Mensola porta elettrotensili
ES Estante para herramientas eléctricas
CN 电动工具架



576x225
x55
mm

 x6



YATO 	Socket quantity / Liczba kieszeni	
YT-09091	6	10

- EN Power tool organizer
PL Półka na elektronarzędzia
DE Elektrowerkzeug-Aufbewahrungsregal
RU Полка для электроинструмента
CZ Závěsný organizér na elektrické nářadí
HU Elektromos szerszámtartó polc

- RO Organizator pt. scule electrice
FR Support pour outils électriques
IT Mensola porta elettrotensili
ES Estante para herramientas eléctricas
CN 电动工具架

465x405
x225
mm

 x4



YATO 	Tray quantity / Liczba półek	Socket quantity / Liczba kieszeni	
YT-09092	2	4	1

- EN Power tool cabinet
PL Szafka na elektronarzędzia
DE Elektrowerkzeug-Wandschrank
RU Шкаф настенный для электроинструмента
CZ Skříňka na elektrické nářadí
HU Elektromos szerszámtartó szekrény



- RO Dulap pt. scule electrice
FR Armoire pour outils électriques
IT Armadietto per elettrotensili
ES Armario para herramientas eléctricas
CN 电动工具柜

480x430
x280
mm

 x4

2x 



YATO 	Socket quantity / Liczba kieszeni	
YT-09093	4	1







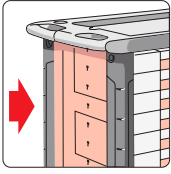







EN Service tool cabinet with tools
 PL Szafka serwisowa z narzędziami
 DE Werkstattwagen mit Werkzeug
 RU Сервисный шкаф с инструментами
 CZ Vozík servisní s nářadím
 HU Szerszámköcski szerszámokkal

RO Dulap echipat cu scule
 FR Servante d'atelier complète
 IT Armadio da officina con attrezzi
 ES Carro taller con herramientas
 CN 维修工具柜





157 PCS	977x725 x 480 mm	7x 	BALL BEARINGS ŁOŻYSKA KULKOWE	 25kg 55lb	CENTRAL LOCK BLOKADA CENTRALNA		OIL PROOF STEEL WORKTOP OLEODOPORNY STALOWY BLAT
3 TRAYS TAGE	EVA	∅120mm 	2x BRAKE HAMULEC	UNIVERSAL PERFORMANCE UNIWERSALNA PERFORMANCJA	CORNER BUMPERS NAROŻNIE ODBOJNIKI	2x 	















Drawer 1 / Szuflada 1

-  1/2" (12.7 mm): 8, 9, 10, 11, 12, 13, 14, 15, 16, 17, 18, 19, 20, 21, 22, 24 (L=38 mm); 27, 30, 32 mm (L=42 mm); 1/4" (6.3 mm): 4, 4.5, 5, 5.5, 6, 7, 8, 9, 10, 11, 12, 13 (L=25 mm); CrV 50BV30;
-  1/2" (12.7 mm): 10, 13, 14, 15, 17, 19, 21 mm (L=76 mm); 1/4" (6.3 mm): 6, 7, 8, 9, 10, 11, 12, 13 (L=50 mm); CrV 50BV30;
-  1/2" (12.7 mm): E10, E11, E12, E14, E16, 1/4" (6.3 mm): E4, E5, E6, E7, E8; CrV 50BV30;
-  1/2" (12.7 mm): (127, 254 mm); 1/4" (6.3 mm): (50.8, 101.6 mm); CrV 50BV30;
-  1/2" (12.7 mm); CrV 50BV30;
-  1/2" (12.7 mm): 16, 21 mm; CrV 50BV30;
-  1/2" (12.7 mm); (255 mm); 1/4" (6.3 mm); (152.4 mm); CrV 50BV30;
-  1/2" (12.7 mm); (255 mm); 1/4" (6.3 mm); (155 mm); CrV 6140;
-  1/4" (6.3 mm); (150 mm); CrV 50BV30;
-  1/4" (6.3 mm): 4, 5.5, 6.5 mm; AISI S2 / CrV 6150;
-  1/4" (6.3 mm): PH1 (x2), PH2 (x2), PH3; AISI S2 / CrV 6150;
-  1/4" (6.3 mm): PZ1, PZ2, PZ3; AISI S2 / CrV 6150;
-  1/4" (6.3 mm): T8, T10, T15, T20, T25, T30, T40; AISI S2 / CrV 6150;
-  1/4" (6.3 mm): 3, 4, 5, 6, 7, 8 mm; AISI S2 / CrV 6150



Drawer 2 / Szuflada 2

-  \varnothing 3-6 mm (L=52 mm), \varnothing 6-8 (L=58 mm), \varnothing 8-11 (L=66 mm), \varnothing 11-14 (L=75 mm), \varnothing 14-18 (L=80 mm), \varnothing 18-25 (L=88 mm);
-  8, 9, 10, 11, 12, 13, 14, 15, 16, 17, 18, 19, 21, 22, 24 mm; CrV;
-  200 mm; CrV;
-  T10, T15, T20, T25, T27, T30, T40, T45, T50; CrV 6150;
-  2, 2.5, 3, 4, 5, 6, 7, 8, 10, 12 mm; CrV 6150

Drawer 3 / Szuflada 3

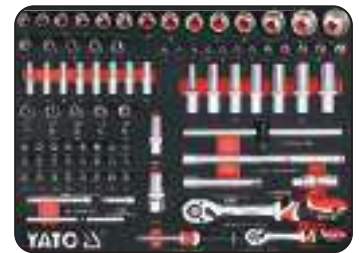
-  6x100 mm; CrV 6150; PH2x100 mm; CrV 6150;
-  6x38, 3x75 mm; S2; PH0x75, PH2x38 mm; S2;
-  180 mm; CrV 50;
-  160 mm; CrV 50;
-  160 mm; CrV 6150;
-  150 mm;
-  180 mm; CrMo;
-  180 mm; CrV 50;
-  180 mm; CrV 50;
-  180 mm; CrV 50;
-  180 mm; CrV 50;
-  1.5, 2, 2.5, 3, 4, 5, 6, 8, 10 mm; CrV 6150



YATO 	Drawer quantity / Liczba szuflad	
YT-55308	7	1

EN Service tool cabinet with tools
PL Szafka serwisowa z narzędziami
DE Werkstattwagen mit Werkzeug
RU Сервисный шкаф с инструментами
CZ Vozík servisní s nářadím
HU Szerszámkocsi szerszámokkal

RO Dulap echipat cu scule
FR Servante d'atelier complète
IT Armadio da officina con attrezzi
ES Carro taller con herramientas
CN 维修工具柜

165
PCS

958x766
x465
mm

7x

BALL BEARINGS
ŁOŻYSKA KULKOWE

DRAWERS
BLOKADA SZUFLAD

CENTRAL LOCK
BLOKADA CENTRALNA

NON SLIP
WORKTOP
BLAT ANTY-
POŚLIZGOWY

∅125mm

BRAKE
HAMULEC

UNIVERSAL PERFORATION
UNIWERSALNA PERFORACJA

DOUBLE WALLS
PODWÓJNE ŚCIANY

CORNER BUMPERS
NARÓŻNE ODBOJNIKI

3x

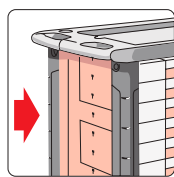

Drawer 1 / Szuflada 1

- 1/2" (12.7 mm), 3/8" (9.5 mm);
- T20, T25, T30, T40, T45, T50, T55 (L=30 mm);
- T20, T25, T30, T40, T45, T50, T55 (L=75 mm); AISI S2;
- 4, 5, 6, 7, 8, 10, 12 mm (L=30 mm); 4, 5, 6, 7, 8, 10, 12 mm (L=75 mm); AISI S2;
- M5, M6, M8, M10, M12 (L=30 mm); M5, M6, M8, M10, M12 (L=75 mm); AISI S2;
- 6, 7, 8, 9, 10, 11, 12, 13, 14, 15, 16, 17, 18, 19, 20, 21 mm; CrV;
- 22, 24, 27, 28, 30, 32 mm; CrV

Drawer 2 / Szuflada 2

- 1/2" (12.7 mm): 10, 11, 12, 13, 14, 15, 16, 17, 18, 19, 20, 21, 22, 23, 24, 27, 30, 32 mm; CrV 50BV30;
- 1/2" (12.7 mm); (127 mm); CrV 50BV30;
- 1/2" (12.7 mm); CrV 50BV30;
- 1/2" (12.7 mm): 16; 21 mm; CrV 50BV30;
- 1/2" (12.7 mm); (255 mm); CrV 50BV30;
- 1/2" (12.7 mm); (255 mm); 72T; CrV 6140;
- 1/4" (6.3 mm): 3.5, 4, 4.5, 5, 5.5, 6, 7, 8, 9, 10, 11, 12, 13, 14 mm; CrV 50BV30;
- 1/4" (6.3 mm): 8, 10, 11, 12, 13 mm; CrV 50BV30;
- 1/4" (6.3 mm); (50.8, 101.6 mm); CrV 6140;
- 1/4" (6.3 mm); CrV 50BV30;
- 1/4" (6.3 mm); (152.4 mm); CrV 50BV30;
- 1/4" (6.3 mm); (155 mm); 72T; CrV 6140;
- 1/4" (6.3 mm); (150 mm); CrV 50BV30;
- 180 mm;
- 160 mm;
- 160 mm long nose;
- 160 mm bent nose

Drawer 3 / Szuflada 3

- 3x75, 5x100, 5x150, 6x38, 6x100, 6x150, 8x150 mm; CrMo;
- PH0x100, PH1x75, PH1x100, PH2x38, PH2x100, PH2x150, PH3x150 mm; CrMo;
- 180, 250 mm;
- 280 mm

Drawer 4 / Szuflada 4

- 3/4" (19.0 mm): 21, 22, 24, 27, 28, 29, 30, 32, 34, 36, 41, 46, 50, 55 mm; CrV 50BV30;
- 3/4" (19.0 mm); (200 mm); CrV 6140;
- 3/4" (19.0 mm); CrV 50BV30;
- 3/4" (19.0 mm); (500 mm); 72T; CrV 6140;
- 3/4" (19.0 mm); (500 mm); CrV 50BV30

Drawer 5 / Szuflada 5

- 1/2" (12.7 mm) x 5/16" (7.9 mm);
- 8 mm (L=35 mm); 8 mm (L=75 mm);
- PH3 (L=35 mm); PH1, PH2, PH3 (L=75 mm);
- 12-38 mm;
- 3" (75 mm);
- 82 mm;
- 200 mm;
- 135 mm;
- 300, 400, 500 mm

13 interchangeable trays with YATO tools
13 wymiennych modułów z narzędziami YATO



YATO	Drawer quantity / Liczba szuflad	
YT-55293	7	1

EN Service tool cabinet with tools
 PL Szafka serwisowa z narzędziami
 DE Werkstattwagen mit Werkzeug
 RU Сервисный шкаф с инструментами
 CZ Vozík servisní s nářadím
 HU Szerszámkocsi szerszámokkal

RO Dulap echipat cu scule
 FR Servante d'atelier complète
 IT Armadio da officina con attrezzi
 ES Carro taller con herramientas
 CN 维修工具柜

177 PCS	970x770 x470 mm	6x	BALL BEARINGS ŁOŻYSKA KULKOWE	DRAWERS LOCKING BLOKADA SZUFLAD	NON-SLP WORKTOP BLAT ANTY- POŚLEDGOWY
∅125mm	BRAKE HAMULEC	UNIVERSAL PERFORATION UNIVERSALNA PERFORACJA	DOUBLE WALLS PODWÓJNE SCIANY	CORNER BUMPERS NARÓŻNE ODBOJNIKI	2x

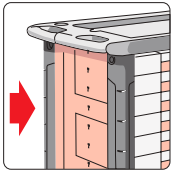

Drawer 1 / Szufłada 1

- ⌀ 6, 7, 8, 9, 10, 11, 12, 13, 14, 15, 16, 17, 18, 19, 20, 21 mm; CrV;
- ⌀ 22, 24, 27, 28, 30, 32 mm; CrV;
- ⌀ 6x7, 8x9, 10x11, 12x13, 14x15, 16x17, 18x19 mm; CrV

Drawer 2 / Szufłada 2

- 3x75, 5x100, 5x150, 6x38, 6x100, 6x150, 8x150 mm; CrMo;
- PH0x100, PH1x75, PH1x100, PH2x38, PH2x100, PH2x150, PH3x150 mm; CrMo;
- 180 mm;
- 160 mm;
- 160 mm long nose;
- 160 mm bent nose

Drawer 3 / Szufłada 3

- 1/2" (12.7 mm): 10, 11, 12, 13, 14, 15, 16, 17, 18, 19, 20, 21, 22, 23, 24, 27, 30, 32 mm; CrV 50BV30;
- 1/2" (12.7 mm); (127 mm); CrV 50BV30;
- 1/2" (12.7 mm); CrV 50BV30;
- 1/2" (12.7 mm): 16; 21 mm; CrV 50BV30;
- 1/2" (12.7 mm); (255 mm); CrV 50BV30;
- 1/2" (12.7 mm); (255 mm); 72T; CrV 6140;
- T20, T25, T30, T40, T45, T50, T55 (L=30 mm); T20, T25, T30, T40, T45, T50, T55 (L=75 mm); AISI S2;
- 4, 5, 6, 7, 8, 10, 12 mm (L=30 mm); 4, 5, 6, 7, 8, 10, 12 mm (L=75 mm); AISI S2;
- M5, M6, M8, M10, M12 (L=30 mm); M5, M6, M8, M10, M12 (L=75 mm); AISI S2;
- 1/2" (12.7 mm), 3/8" (9.5 mm);
- 1/2" (12.7 mm): 8, 9, 10, 11, 12, 13, 14, 15, 16, 17, 18, 19, 20, 21 mm (L=76 mm); CrV 50BV30

Drawer 4 / Szufłada 4

- 300 g (L=300 mm);
- 40 mm (L=350 mm);
- 10x8x142 mm, 12x10x152 mm, 16x13x172 mm;
- 3/8" (9.5 mm): 6, 7, 8, 9, 10, 11, 12, 13, 14, 15, 16, 17, 18, 19, 20, 21, 22 mm; CrV 50BV30;
- 3/8" (9.5 mm); (76, 152.4 mm); CrV 50BV30;
- 3/8" (9.5 mm); CrV 50BV30;
- 3/8" (9.5 mm); (198 mm); CrV 50BV30;
- 3/8" (9.5 mm); (200 mm); 72T; CrV 6140;
- 1/4" (6.3 mm): 3.5, 4, 4.5, 5, 5.5, 6, 7, 8, 9, 10, 11, 12, 13, 14 mm; CrV 50BV30;
- 1/4" (6.3 mm): 8, 10, 11, 12, 13 mm; CrV 50BV30;
- 1/4" (6.3 mm); (50.8, 101.6 mm); CrV 6140;
- 1/4" (6.3 mm); CrV 50BV30;
- 1/4" (6.3 mm); (152.4 mm); CrV 50BV30
- 1/4" (6.3 mm); (155 mm); 72T; CrV 6140;
- 1/4" (6.3 mm); (150 mm); CrV 50BV30

12 interchangeable trays with YATO tools
 12 wymiennych modułów z narzędziami YATO



YATO	Drawer quantity / Liczba szuflad	
YT-5530	6	1

EN Service tool cabinet with tools
PL Szafka serwisowa z narzędziami
DE Werkstattwagen mit Werkzeug
RU Сервисный шкаф с инструментами
CZ Vozík servisní s nářadím
HU Szerszámkocsi szerszámokkal

RO Dulap echipat cu scule
FR Servante d'atelier complète
IT Armadio da officina con attrezzi
ES Carro taller con herramientas
CN 维修工具柜

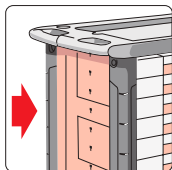

Drawer 1 / Szufłada 1

- 6, 7, 8, 9, 10, 11, 12, 13, 14, 15, 16, 17, 18, 19, 20, 21 mm; CrV;
- 22, 24, 27, 28, 30, 32 mm; CrV;
- 6x7, 8x9, 10x11, 12x13, 14x15, 16x17, 18x19 mm; CrV

Drawer 2 / Szufłada 2

- 3x75, 5x100, 5x150, 6x38, 6x100, 6x150, 8x150 mm; CrMo;
- PH0x100, PH1x75, PH1x100, PH2x38, PH2x100, PH2x150, PH3x150 mm; CrMo;
- 180 mm;
- 160 mm;
- 160 mm long nose;
- 160 mm bent nose

Drawer 3 / Szufłada 3

- 1/2" (12.7 mm): 10, 11, 12, 13, 14, 15, 16, 17, 18, 19, 20, 21, 22, 23, 24, 27, 30, 32 mm; CrV 50BV30;
- 1/2" (12.7 mm); (127 mm); CrV 50BV30;
- 1/2" (12.7 mm); CrV 50BV30;
- 1/2" (12.7 mm): 16, 21 mm; CrV 50BV30;
- 1/2" (12.7 mm); (255 mm); CrV 50BV30;
- 1/2" (12.7 mm); (255 mm); 72T; CrV 6140;
- T20, T25, T30, T40, T45, T50, T55 (L=30 mm); T20, T25, T30, T40, T45, T50, T55 (L=75 mm); AISI S2;
- 4, 5, 6, 7, 8, 10, 12 mm (L=30 mm); 4, 5, 6, 7, 8, 10, 12 mm (L=75 mm); AISI S2;
- M5, M6, M8, M10, M12 (L=30 mm); M5, M6, M8, M10, M12 (L=75 mm); AISI S2;
- 1/2" (12.7 mm); 3/8" (9.5 mm);
- 1/2" (12.7 mm); 8, 9, 10, 11, 12, 13, 14, 15, 16, 17, 18, 19, 20, 21 mm (L=76 mm); CrV 50BV30

Drawer 4 / Szufłada 4

- 300 g (L=300 mm);
- 40 mm (L=350 mm);
- 10x8x142 mm, 12x10x152 mm, 16x13x172 mm;
- 3/8" (9.5 mm): 6, 7, 8, 9, 10, 11, 12, 13, 14, 15, 16, 17, 18, 19, 20, 21, 22 mm; CrV 50BV30;
- 3/8" (9.5 mm); (76, 152.4 mm); CrV 50BV30;
- 3/8" (9.5 mm); CrV 50BV30;
- 3/8" (9.5 mm); (198 mm); CrV 50BV30;
- 3/8" (9.5 mm); (200 mm); 72T; CrV 6140;
- 1/4" (6.3 mm): 3.5, 4, 4.5, 5, 5.5, 6, 7, 8, 9, 10, 11, 12, 13, 14 mm; CrV 50BV30;
- 1/4" (6.3 mm): 8, 10, 11, 12, 13 mm; CrV 50BV30;
- 1/4" (6.3 mm); (50.8, 101.6 mm); CrV 6140;
- 1/4" (6.3 mm); CrV 50BV30;
- 1/4" (6.3 mm); (152.4 mm); CrV 50BV30
- 1/4" (6.3 mm); (155 mm); 72T; CrV 6140;
- 1/4" (6.3 mm); (150 mm); CrV 50BV30

12 interchangeable trays with YATO tools
12 wymiennych modułów z narzędziami YATO



YATO	Drawer quantity / Liczba szuflad	
YT-55300	6	1

EN Service tool cabinet with tools
 PL Szafka serwisowa z narzędziami
 DE Werkstattwagen mit Werkzeug
 RU Сервисный шкаф с инструментами
 CZ Vozík servisní s nářadím
 HU Szerszámkocsi szerszámokkal

RO Dulap echipat cu scule
 FR Servante d'atelier complète
 IT Armadio da officina con attrezzi
 ES Carro taller con herramientas
 CN 维修工具柜

185
PCS

970x770
x470
mm

6x

BALL BEARINGS
ŁOŻYSKA
KULKOWE

DRAWERS
LOCKING
BLOKADA
SZUFLAD

NON SLIP
WORKTOP
BLAT ANTY-
POŚLIZGOWY

Ø125mm

UNIVERSAL
PERFORATION
UNIVERSALNA
PERFORACJA

DOUBLE
WALLS
PODWÓJNE
ŚCIANY

CORNER
BUMBERS
NAROŻNE
ODBOJNIKI

2x

1

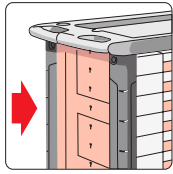

Drawer 1 / Szuflada 1

- 6, 7, 8, 9, 10, 11, 12, 13, 14, 15, 16, 17, 18, 19, 20, 21 mm; CrV;
- 22, 24, 27, 28, 30, 32 mm; CrV;
- 6x7, 8x9, 10x11, 12x13, 14x15, 16x17, 18x19 mm; CrV

Drawer 2 / Szuflada 2

- 3x75, 5x100, 5x150, 6x38, 6x100, 6x150, 8x150 mm; CrMo;
- PH0x100, PH1x75, PH1x100, PH2x38, PH2x100, PH2x150, PH3x150 mm; CrMo;
- 180 mm;
- 160 mm;
- 160 mm long nose;
- 160 mm bent nose

Drawer 3 / Szuflada 3

- 1/2" (12.7 mm): 10, 11, 12, 13, 14, 15, 16, 17, 18, 19, 20, 21, 22, 23, 24, 27, 30, 32 mm; CrV 50BV30;
- 1/2" (12.7 mm); (127 mm); CrV 50BV30;
- 1/2" (12.7 mm); CrV 50BV30;
- 1/2" (12.7 mm): 16, 21 mm; CrV 50BV30;
- 1/2" (12.7 mm); (255 mm); CrV 50BV30;
- 1/2" (12.7 mm); (255 mm); T2T; CrV 6140;
- T20, T25, T30, T40, T45, T50, T55 (L=30 mm); T20, T25, T30, T40, T45, T50, T55 (L=75 mm); AISI S2;
- 4, 5, 6, 7, 8, 10, 12 mm (L=30 mm); 4, 5, 6, 7, 8, 10, 12 mm (L=75 mm); AISI S2;
- M5, M6, M8, M10, M12 (L=30 mm); M5, M6, M8, M10, M12 (L=75 mm); AISI S2;
- 1/2" (12.7 mm), 3/8" (9.5 mm);
- 1/2" (12.7 mm): 8, 9, 10, 11, 12, 13, 14, 15, 16, 17, 18, 19, 20, 21 mm (L=76 mm); CrV 50BV30

Drawer 4 / Szuflada 4

- 300 g (L=300 mm);
- Ø 40 mm (L=350 mm);
- 10x8x142 mm, 12x10x152 mm, 16x13x170 mm;
- 1/4" (6.3 mm): 3.5, 4, 4.5, 5, 5.5, 6, 7, 8, 9, 10, 11, 12, 13, 14 mm; CrV 50BV30;
- 1/4" (6.3 mm): 8, 10, 11, 12, 13 mm; CrV 50BV30;
- 1/4" (6.3 mm); (50.8, 101.6 mm); CrV 6140;
- 1/4" (6.3 mm); CrV 50BV30;
- 1/4" (6.3 mm); (152.4 mm); CrV 50BV30;
- 1/4" (6.3 mm); (155 mm); T2T; CrV 6140;
- 1/4" (6.3 mm); (150 mm); CrV 50BV30;
- 1/2" (12.5 mm): E10, E12, E14, E16, E18, E20;
- 1/4" (6.3 mm): E4, E5, E6, E7, E8;
- 2, 2.5, 3, 4, 5, 6, 7, 8, 10, 12 mm;
- T10, T15, T20, T25, T27, T30, T40, T45, T50

12 interchangeable trays with YATO tools
 12 wymiennych modułów z narzędziami YATO



YATO
YT-55307

Drawer quantity / Liczba szuflad

6

1

EN Service tool cabinet with tools
PL Szafka serwisowa z narzędziami
DE Werkstattwagen mit Werkzeug
RU Сервисный шкаф с инструментами
CZ Vozík servisní s nářadím
HU Szerszámkocsi szerszámokkal

RO Dulap echipat cu scule
FR Servante d'atelier complète
IT Armadio da officina con attrezzi
ES Carro taller con herramientas
CN 维修工具柜

211
PCS

980x770
x465
mm

7x

BALL BEARINGS
ŁOŻYSKA
KULKOWE

DRAWERS
LOCKING
BLOKADA
SZUFLAD

NON SLIP
WORKTOP
BLAT ANTY-
POŚLIZGOWY

Ø125mm

CORNER
BUMPER
NAROŻNE
ODBOJNIKI

UNIVERSAL
PERFORATION
UNIWERSALNA
PERFORACJA

DOUBLE
WALLS
PODWOJNE
ŚCIANY

3x

KEY

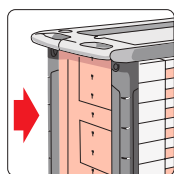

Drawer 1 / Szufłada 1

- 1/2" (12.7 mm): 8, 9, 10, 11, 12, 13, 14, 15, 16, 17, 18, 19, 20, 21, 22, 24 mm (L=38 mm); 27, 30, 32 mm (L=42 mm), 1/4" (6.3 mm): 4, 4.5, 5, 5.5, 6, 7, 8, 9, 10, 11, 12, 13 mm (L=25 mm); CrV 50BV30;
- 1/4" (6.3 mm): 10, 13, 14, 15, 17, 19, 21 mm (L=76 mm), 1/4" (6.3 mm): 6, 7, 8, 9, 10, 11, 12, 13 mm (L=50 mm); CrV 50BV30;
- 1/2" (12.7 mm): E10, E11, E12, E14, E16, 1/4" (6.3 mm): E4, E5, E6, E7, E8; CrV 50BV30;
- 1/2" (12.7 mm): (127, 254 mm), 1/4" (6.3 mm): (50.8, 101.6 mm); CrV 50BV30;
- 1/2" (12.7 mm); CrV 50BV30;
- 1/2" (12.7 mm): 16, 21 mm; CrV 50BV30;
- 1/2" (12.7 mm); (255 mm), 1/4" (6.3 mm); (152.4 mm); CrV 50BV30;
- 1/2" (12.7 mm); (255 mm), 1/4" (6.3 mm); (155 mm); CrV 6140;
- 1/4" (6.3 mm); (150 mm); CrV 50BV30;
- 1/4" (6.3 mm): 4, 5.5, 6.5 mm; AISI S2 / CrV 6150;
- 1/4" (6.3 mm): PH1 x2, PH2 x2, PH3; AISI S2 / CrV 6150;
- 1/4" (6.3 mm): PZ1, PZ2, PZ3; AISI S2 / CrV 6150;
- 1/4" (6.3 mm): T8, T10, T15, T20, T25, T30, T40; AISI S2 / CrV 6150;
- 1/4" (6.3 mm): 3, 4, 5, 6, 7, 8 mm; AISI S2 / CrV 6150

Drawer 2 / Szufłada 2

- 200 mm; CrV;
- Ø 3-6 mm (L=52 mm), Ø 6-8 mm (L=58 mm), Ø 8-11 mm (L=66 mm), Ø 11-14 mm (L=75 mm), Ø 14-18 mm (L=80 mm), Ø 18-25 mm (L=88 mm); 8, 9, 10, 11, 12, 13, 14, 15, 16, 17, 18, 19, 21, 22, 24 mm; CrV;
- T10, T15, T20, T25, T27, T30, T40, T45, T50; CrV 6150;
- 2, 2.5, 3, 4, 5, 6, 7, 8, 10, 12 mm; CrV 6150

Drawer 3 / Szufłada 3

- 6x38, 2x75, 3x75, 4x100, 5x100, 6x100 mm; PH0x100, PH1x100, PH2x38, PH2x150, PH3x150 mm; T7x75, T8x75, T9x75, T10x100, T15x100, T20x100, T25x100, T27x100 mm; S2; 6,0x150 mm; PH2x150 mm; CrV 6150

Drawer 4 / Szufłada 4

- 180 mm;
- 160 mm;
- 200 mm;
- 250 mm;
- 400 g;
- 340 g;
- 12.5x152, 16.0x172 mm; CrV 6150;
- 3x150, 4x150, 5x150, 6x150, 8x150 mm; CrV 6150;
- 8x112 mm; CrV 6150

Drawer 5 / Szufłada 5

- M3x0.5 x3, M4x0.7 x3, M5x0.8 x3, M6x1.0 x3, M7x1.0 x3, M8x1.25 x3, M10x1.5 x3, M12x1.75 x3; HSS M2;
- M3, M4x0.7, M5x0.8, M6x1.0, M7x1.0, M8x1.25, M10x1.5, M12x1.75; HSS M2;
- M7-M9;
- M3-M12;
- #2, 200 mm;
- #2, 200 mm;
- #2, 200 mm;
- LED;
- 3 m x 16 mm;
- 300 mm;
- 0-150 mm

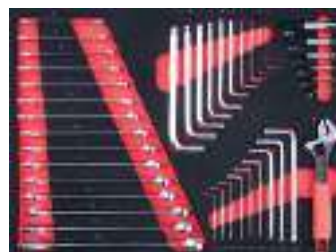

YATO	Drawer quantity / Liczba szuflad	
YT-55290	7	1

CREATE YOUR WORKPLACE - STWÓRZ SVOJE MIEJSCE PRACY



EN Tool chest
 PL Szafka warsztatowa
 DE Werkzeugkasten
 RU Портативный ящик для инструментов
 CZ Přenosná skříňka na nářadí
 HU Hordozható szerszámós láda
 RO Cabinet pt. scule
 FR Servante d'atelier
 IT Armadio con cassetti per officina
 ES Cajonera portátil
 CN 工具柜

690x465 x400 mm

4x

UNIVERSAL PERFORATION UNIVERSÁLNA PERFORÁCIA

DOUBLE WALLS PODWÓJNE ŚCIANY

DRAWERS LOCKING BLOKADA SZUFLAD

CORNER BUMPERS NARÓŻNE ODBOJNIKI

CENTRAL LOCK BLOKADA CENTRALNA

NON SLIP WORKTOP BLAT ANTY-POŚLĘGOWY

2x

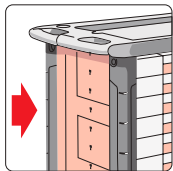

YATO	Drawer quantity / Liczba szuflad	
YT-09152	4	1

EN Tool chest
 PL Szafka warsztatowa
 DE Werkzeugkasten
 RU Портативный ящик для инструментов
 CZ Přenosná skříňka na nářadí
 HU Hordozható szerszámós láda
 RO Cabinet pt. scule
 FR Servante d'atelier
 IT Armadio con cassetti per officina
 ES Cajonera portátil
 CN 工具柜

690x465 x535 mm

6x

UNIVERSAL PERFORATION UNIVERSÁLNA PERFORÁCIA

DOUBLE WALLS PODWÓJNE ŚCIANY

DRAWERS LOCKING BLOKADA SZUFLAD

CORNER BUMPERS NARÓŻNE ODBOJNIKI

CENTRAL LOCK BLOKADA CENTRALNA

NON SLIP WORKTOP BLAT ANTY-POŚLĘGOWY

2x

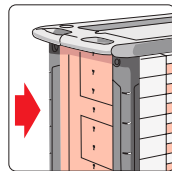

YATO	Drawer quantity / Liczba szuflad	
YT-09155	6	1

EN Roller cabinet
 PL Szafka serwisowa
 DE Werkstattrollwagen
 RU Инструментальный кабинет
 CZ Dilenská skříňka
 HU Szerszámós kocsi
 RO Dulap de scule
 FR Servante d'atelier
 IT Armadio da officina per attrezzi
 ES Armario en ruedas
 CN 高档6抽屉边柜工具车

1000x1130 x570 mm

6+1

UNIVERSAL PERFORATION UNIVERSÁLNA PERFORÁCIA

DOUBLE WALLS PODWÓJNE ŚCIANY

DRAWERS LOCKING BLOKADA SZUFLAD

CORNER BUMPERS NARÓŻNE ODBOJNIKI

OL PROOF STEEL WORKTOP OLEOOPORNY STALOWY BLAT

Ø160 mm

2x

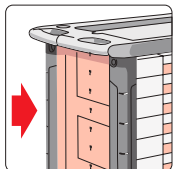

YATO	Drawer quantity / Liczba szuflad	
YT-09002	6+1	1

EN Roller cabinet
 PL Szafka serwisowa
 DE Werkstattrollwagen
 RU Инструментальный кабинет
 CZ Dilenská skříňka
 HU Szerszámós kocsi
 RO Dulap de scule
 FR Servante d'atelier
 IT Armadio da officina per attrezzi
 ES Armario en ruedas
 CN 高档12抽屉工具车

1000x1130 x570 mm

12x

UNIVERSAL PERFORATION UNIVERSÁLNA PERFORÁCIA

DOUBLE WALLS PODWÓJNE ŚCIANY

DRAWERS LOCKING BLOKADA SZUFLAD

CORNER BUMPERS NARÓŻNE ODBOJNIKI

OL PROOF STEEL WORKTOP OLEOOPORNY STALOWY BLAT

Ø160 mm

2x

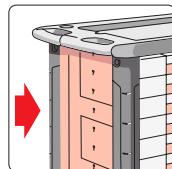

YATO	Drawer quantity / Liczba szuflad	
YT-09003	12	1

EN Roller cabinet
PL Szafka serwisowa
DE Werkstattrollwagen
RU Инструментальный кабинет
CZ Dilenská skříňka
HU Szerszámok kocsis
RO Dulap de scule
FR Servante d'atelier
IT Armadio da officina per attrezzi
ES Armario en ruedas
CN 工具车



YATO	Drawer quantity / Liczba szuflad	
YT-09004	7	1

EN Roller cabinet
PL Szafka serwisowa
DE Werkstattrollwagen
RU Инструментальный кабинет
CZ Dilenská skříňka
HU Szerszámok kocsis
RO Dulap de scule
FR Servante d'atelier
IT Armadio da officina per attrezzi
ES Armario en ruedas
CN 工具车



YATO	Drawer quantity / Liczba szuflad	
YT-09033	7+1	1

EN Roller cabinet
PL Szafka serwisowa
DE Werkstattrollwagen
RU Инструментальный кабинет
CZ Dilenská skříňka
HU Szerszámok kocsis
RO Dulap de scule
FR Servante d'atelier
IT Armadio da officina per attrezzi
ES Armario en ruedas
CN 工具车

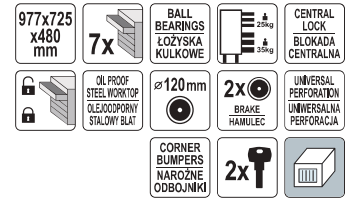

YATO	Drawer quantity / Liczba szuflad	
YT-09032	7	1

EN Roller cabinet
PL Szafka serwisowa
DE Werkstattrollwagen
RU Инструментальный кабинет
CZ Dilenská skříňka
HU Szerszámok kocsis
RO Dulap de scule
FR Servante d'atelier
IT Armadio da officina per attrezzi
ES Armario en ruedas
CN 工具车



YATO	Drawer quantity / Liczba szuflad	
YT-0913	6	1

EN Roller cabinet
 PL Szafka serwisowa
 DE Werkstattrollwagen
 RU Инструментальный кабинет
 CZ Dilenská skříňka
 HU Szerszámos kocsis
 RO Dulap de scule
 FR Servante d'atelier
 IT Armadio da officina per attrezzi
 ES Armario en ruedas
 CN 工具车



995x680 x458 mm	7x	BALL BEARINGS ŁOŻYSKA KULKOWE	max 300 kg	DRAWERS LOCKING BLOKADA SZUFLAD
CENTRAL LOCK BLOKADA CENTRALNA	NON SLIP WORKTOP BLAT ANTY- POŚLĘGOWY	∅127 mm	2x BRAKE HAMULEC	2xT
				





EN Roller cabinet
 PL Szafka serwisowa
 DE Werkstattrollwagen
 RU Инструментальный кабинет
 CZ Dilenská skříňka
 HU Szerszámos kocsis
 RO Dulap de scule
 FR Servante d'atelier
 IT Armadio da officina per attrezzi
 ES Armario en ruedas
 CN 工具车

958x766 x465 mm	6x	BALL BEARINGS ŁOŻYSKA KULKOWE	∅125 mm	CORNER BUMPERS NARÓŻNE ODBOJNIKI
DRAWERS LOCKING BLOKADA SZUFLAD	CENTRAL LOCK BLOKADA CENTRALNA	NON SLIP WORKTOP BLAT ANTY- POŚLĘGOWY	2x BRAKE HAMULEC	2xT
				



YATO  Drawer quantity / Liczba szuflad 
 YT-0914 7 1

YATO  Drawer quantity / Liczba szuflad 
 YT-0902 6 1

EN Roller cabinet
 PL Szafka serwisowa
 DE Werkstattrollwagen
 RU Инструментальный кабинет
 CZ Dilenská skříňka
 HU Szerszámos kocsis
 RO Dulap de scule
 FR Servante d'atelier
 IT Armadio da officina per attrezzi
 ES Armario en ruedas
 CN 工具车

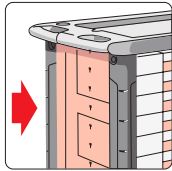



975x765 x465 mm	6x	BALL BEARINGS ŁOŻYSKA KULKOWE	∅125 mm	CORNER BUMPERS NARÓŻNE ODBOJNIKI
DRAWERS LOCKING BLOKADA SZUFLAD	NON SLIP WORKTOP BLAT ANTY- POŚLĘGOWY	∅111 mm	2x BRAKE HAMULEC	2xT
				



EN Roller cabinet
 PL Szafka serwisowa
 DE Werkstattrollwagen
 RU Инструментальный кабинет
 CZ Dilenská skříňka
 HU Szerszámos kocsis
 RO Dulap de scule
 FR Servante d'atelier
 IT Armadio da officina per attrezzi
 ES Armario en ruedas
 CN 工具车

944x665 x453 mm	7x	BALL BEARINGS ŁOŻYSKA KULKOWE	∅111 mm	CORNER BUMPERS NARÓŻNE ODBOJNIKI
DRAWERS LOCKING BLOKADA SZUFLAD	CENTRAL LOCK BLOKADA CENTRALNA	NON SLIP WORKTOP BLAT ANTY- POŚLĘGOWY	2x BRAKE HAMULEC	2xT
				



YATO  Drawer quantity / Liczba szuflad 
 YT-55299 6 1

YATO  Drawer quantity / Liczba szuflad 
 YT-09000 7 1

EN Workshop trolley
PL Wózek warsztatowy
DE Werkstatt-Servicewagen
RU Инструментальная тележка
CZ Dílenský policosový vozík
HU Műhelykocsi
RO Carucior pt. atelier
FR Chariot d'atelier
IT Carrello da officina
ES Carro para taller
CN 三层工具车



YATO Tray quantity / Liczba pólek
YT-55210 3 1

EN Shutter cabinet
PL Szafka wisząca
DE Werkstatt Hängeschrank
RU Шкафчик для инструмента настенный
CZ Zavěšená skříňka
HU Szerszámtároló
RO Raft de scule
FR Placard d'atelier
IT Scaffale
ES Armario colgante
CN 卷帘柜



YATO Dimensions / Wymiary [mm]
YT-09061 1500x605x185 1

EN Drawer insert / Combination spanners
PL Wkład do szuflady / Klucze płasko-oczkowe
DE Schubladeneinlage / Schrauben- und Ringschlüssel
RU Вклад к выдвижному ящику / Плоско-закрытый накладной ключ
CZ Vložka do zásuvky / Klíče ploché-očkové
HU Fiókbetét / Csillag - villás kulcsok
RO Adaos la sertar / Chei plane - inelare
FR Module plastique pour servante avec clés mixtes
IT Tenone per l'armadio chiavi
ES Accesorio de cajón / Llave española de muletilla
CN 两用扳手托盘组套



22, 24, 27, 28, 30, 32 mm; CrV

YATO
YT-5532 4

EN Workshop trolley
PL Wózek warsztatowy
DE Werkstatt-Servicewagen
RU Инструментальная тележка
CZ Dílenský policosový vozík
HU Műhelykocsi
RO Carucior pt. atelier
FR Chariot d'atelier
IT Carrello da officina
ES Carro para taller
CN 三层工具车



YATO Tray quantity / Liczba pólek
YT-55212 3 1

EN Workbench
PL Stół warsztatowy
DE Werkbank
RU Бесстрах
CZ Pracovní stůl
HU Munkapad
RO Banc de lucru
FR Table d'atelier
IT Banco da lavoro
ES Banco de trabajo
CN 工作台



YATO Dimensions / Wymiary [mm]
YT-08920 1500x780x830 1

EN Drawer insert / Bi-hexagonal ring spanner
PL Wkład do szuflady / Klucze oczkowe odgięte
DE Schubladeneinlage / Doppelringschlüssel
RU Вклад к выдвижному ящику / Ключ накидной изогнутый
CZ Vložka do zásuvky / Klíče očkové ohnuté
HU Fiókbetét / Hajlítottszerű csillagkulcs
RO Adaos la sertar / Chei inelaro-curbată
FR Module plastique pour servante clés contre-coudées
IT Tenone per l'armadio chiavi
ES Accesorio de cajón / Llave de estrella
CN 双头高颈梅花扳手托盘组套

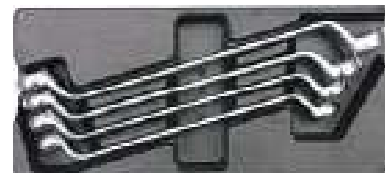

21x23, 24x27, 25x28, 30x32 mm; CrV

YATO
YT-5543 8

EN Drawer insert / Combination spanners
 PL Wkład do szuflady / Klucze płasko-oczkowe
 DE Schubladeneinlage / Schrauben- und Ringschlüssel
 RU Вклад к выдвижному ящику / Плоско-закрытый накладной ключ
 CZ Vložka do zásuvky / Klíče ploché-ocňové
 HU Fiókbetét / Csillag - villás kulcsok
 RO Adaos la sertar / Chei plane - inelare
 FR Module plastique pour servante avec clés mixtes
 IT Tenone per l'armadio chiavi
 ES Accesorio de cajón / Llave española de muletilla
 CN 两用扳手套盒组套

16 PCS CrV



6, 7, 8, 9, 10, 11, 12, 13, 14, 15, 16, 17, 18, 19, 20, 21 mm; CrV

YATO **YT-5531** 8

EN Drawer insert / Bi-hexagonal ring spanner
 PL Wkład do szuflady / Klucze oczkowe odgięte
 DE Schubladeneinlage / Doppelringschlüssel
 RU Вклад к выдвижному ящику / Ключ накидной изогнутый
 CZ Vložka do zásuvky / Klíče očkové ohnuté
 HU Fiókbetét / Hajlítottszerű csillagkulcs
 RO Adaos la sertar / Chei inelaro-curbată
 FR Module plastique pour servante clés contre-coudées
 IT Tenone per l'armadio chiavi
 ES Accesorio de cajón / Llave de estrella
 CN 双头高颈梅花扳手托盘组套

7 PCS CrV



6x7, 8x9, 10x11, 12x13, 14x15, 16x17, 18x19 mm; CrV

YATO **YT-5533** 8

EN Drawer insert / L-type socket wrench
 PL Wkład do szuflady / Klucz nasadowy typ „L”
 DE Schubladeneinlage / Steckschlüssel gebogen
 RU Вклад к выдвижному ящику / Ключ торцевой L-типа
 CZ Vložka do zásuvky / Nástrčný klíč fajtkový
 HU Fiókbetét / Kulcs, dugó-pipa
 RO Adaos la sertar / Cheie tubulara cu cot tip „L”
 FR Module plastique pour servante / Clé a douille de type „L”
 IT Tenone per l'armadio / Chiave a tubo tipo „L”
 ES Accesorio de cajón / Llave de vaso „L”
 CN 套筒托盘工具组套

10 PCS CrV

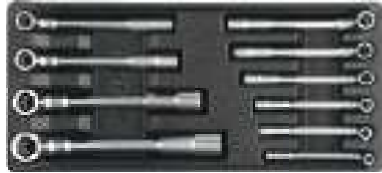

7, 8, 9, 10, 11, 12, 13, 14, 17, 19 mm; CrV

YATO **YT-55456** 4

EN Drawer insert / Pliers
 PL Wkład do szuflady / Szczypce
 DE Schubladeneinlage / Zangen
 RU Вклад к выдвижному ящику / Клещи
 CZ Vložka do zásuvky / Kleště
 HU Fiókbetét / Fogó készlet
 RO Adaos la sertar / Clește
 FR Module plastique pour servante avec pinces
 IT Tenone per l'armadio / Pinze
 ES Accesorio de cajón / Pinzas
 CN 钳子托盘组套

4 PCS CrV

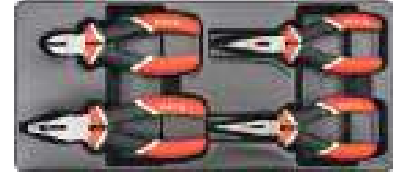

180 mm; CrV;
 160 mm; CrV;
 160 mm long nose; CrV;
 160 mm bent nose; CrV

YATO **YT-5534** 8

EN Drawer insert / Pliers
 PL Wkład do szuflady / Szczypce
 DE Schubladeneinlage / Zangen
 RU Вклад к выдвижному ящику / Клещи
 CZ Vložka do zásuvky / Kleště
 HU Fiókbetét / Zégerfogó készlet
 RO Adaos la sertar / Clește
 FR Module plastique pour servante avec pinces
 IT Tenone per l'armadio / Pinze
 ES Accesorio de cajón / Pinzas
 CN 卡簧钳托盘组套

4 PCS CrV



180 mm; external straight; CrV;
 180 mm; internal straight; CrV;
 180 mm; external bent; CrV;
 180 mm; internal bent; CrV

YATO **YT-55443** 8

EN Drawer insert / Pliers
 PL Wkład do szuflady / Szczypce
 DE Schubladeneinlage / Zangen
 RU Вклад к выдвижному ящику / Клещи
 CZ Vložka do zásuvky / Kleště
 HU Fiókbetét / Fogók
 RO Adaos la sertar / Clește
 FR Module plastique pour servante avec pinces
 IT Tenone per l'armadio / Pinze
 ES Accesorio de cajón / Pinzas
 CN 钳子托盘组套

3 PCS CrMo CrV



180 mm;
 250 mm; CrMo;
 250 mm; CrV

YATO **YT-55463** 8

EN Drawer insert / Pliers
 PL Wkład do szuflady / Szczypce
 DE Schubladeneinlage / Zangen
 RU Вклад к выдвижному ящику / Клещи
 CZ Vložka do zásuvky / Kleště
 HU Fiókbetét / Fogók
 RO Adaos la sertar / Clește
 FR Module plastique pour servante avec pinces
 IT Tenone per l'armadio / Pinze
 ES Accesorio de cajón / Pinzas
 CN 大力钳托盘组套

3 PCS CrMo CrV



180, 250 mm; CrMo;
 280 mm; CrV

YATO **YT-55472** 8

EN Drawer insert / Pliers
 PL Wkład do szuflady / Szczypce
 DE Schubladeneinlage / Zangen
 RU Вклад к выдвижному ящику / Клещи
 CZ Vložka do zásuvky / Kleště
 HU Fiókbetét / Fogók
 RO Adaos la sertar / Clește
 FR Module plastique pour servante avec pinces
 IT Tenone per l'armadio / Pinze
 ES Accesorio de cajón / Pinzas
 CN 钳子托盘组套

3 PCS CrMo CrV



250 mm; CrV;
 125 mm; CrMo;
 300 mm; CrV

YATO **YT-55473** 8

EN Drawer insert / Tool set for plumbers
PL Wkład do szuflady / Zestaw narzędziowy dla hydraulików
DE Schubladeneinlage / Werkzeug-Set für Klempner
RU Вклад к выдвижному ящику / Набор инструментов для водопроводчик
CZ Vložka do zásuvky / Sada nářadí pro instalatér
HU Fiókbetét / Szerszámkészlet vízvezeték-szerelő
RO Adaos la sertar / Set de instrumente pt. instalator
FR Module plastique pour servante / Ensemble d'outils pour les plombier
IT Tenone per l'armadio / Tool set per idraulici
ES Accesorio de cajón / Conjunto de herramientas para fontanero
CN 管道工具组套

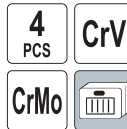

250 mm; CrV;
 330 mm; CrV 6140;
 250 mm; CrMo;
 15 m x 19 mm; PTFE



YATO
YT-55480



5

EN Drawer insert / Tool set for plumbers
PL Wkład do szuflady / Zestaw narzędziowy dla hydraulików
DE Schubladeneinlage / Werkzeug-Set für Klempner
RU Вклад к выдвижному ящику / Набор инструментов для водопроводчик
CZ Vložka do zásuvky / Sada nářadí pro instalatér
HU Fiókbetét / Szerszámkészlet vízvezeték-szerelő
RO Adaos la sertar / Set de instrumente pt. instalator
FR Module plastique pour servante / Ensemble d'outils pour les plombier
IT Tenone per l'armadio / Tool set per idraulici
ES Accesorio de cajón / Conjunto de herramientas para fontanero
CN 管道工具组套

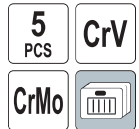

250 mm;
 300 mm;
 250 mm; CrV;
 3-32 mm;
 10 m x 12 mm; PTFE



YATO
YT-55481



5

EN Drawer insert / Pliers and adjustable wrenches
PL Wkład do szuflady / Szczypce i klucze nastawne
DE Schubladeneinlage / Zangen und rollgabelschlüssel
RU Вклад к выдвижному ящику / Клещи и ключ разводной
CZ Vložka do zásuvky / Kleště, nastavitelný klíč
HU Fiókbetét / Fogók és állítható svédkulcs
RO Adaos la sertar / Clește și cheie reglabilă
FR Module plastique pour servante / Pincés et clé a molette
IT Tenone per l'armadio / Pinze
ES Accesorio de cajón / Pinzas y llave ajustable
CN 活扳手及大力钳托盘组套



200, 250 mm;
 250 mm; CrMo;
 150 mm; CrMo



YATO
YT-55444



8

EN Drawer insert / Pliers
PL Wkład do szuflady / Szczypce
DE Schubladeneinlage / Zangen
RU Вклад к выдвижному ящику / Клещи
CZ Vložka do zásuvky / Kleště
HU Fiókbetét / Fogók
RO Adaos la sertar / Clește
FR Module plastique pour servante avec pincés
IT Tenone per l'armadio / Pinze
ES Accesorio de cajón / Pinzas
CN 绝缘钳子托盘组套



180 mm; 1000V; CrV;
 160 mm; 1000V; CrV;
 160 mm; 1000V; CrV;
 175 mm; 1000V

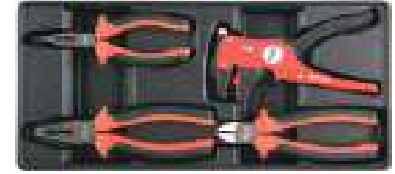

YATO
YT-55464



8

EN Drawer insert / Slotted screwdrivers
PL Wkład do szuflady / Wkrętaki płaskie
DE Schubladeneinlage / Flachschrauber
RU Вклад к выдвижному ящику / Плоские отвёртки
CZ Vložka do zásuvky / Šroubováky ploché
HU Fiókbetét / Lapos csavarhúzó
RO Adaos la sertar / Șurubelnițe plane
FR Module plastique pour servante avec tournevis
IT Tenone per l'armadio / Set di cacciaviti piatti
ES Accesorio de cajón / Desarmadores planos
CN 一字螺丝批托盘组套



3x75, 5x100, 5x150, 6x38, 6x100, 6x150, 8x150 mm; CrMo

YATO
YT-5535



8

EN Drawer insert / Phillips screwdrivers
PL Wkład do szuflady / Wkrętaki krzyżakowe
DE Schubladeneinlage / Kreuzschlitzschrauber
RU Вклад к выдвижному ящику / Крестовидные отвёртки
CZ Vložka do zásuvky / Šroubováky křížové
HU Fiókbetét / Kereszt csavarhúzó
RO Adaos la sertar / Șurubelnițe în cruce
FR Module plastique pour servante avec tournevis
IT Tenone per l'armadio / Set di cacciaviti a croce
ES Accesorio de cajón / Desarmadores de cruz
CN 十字螺丝批托盘组套



PH0x100, PH1x75, PH1x100, PH2x38, PH2x100, PH2x150, PH3x150 mm; CrMo

YATO
YT-5536



8

EN Drawer insert / Screwdriver set
PL Wkład do szuflady / Komplet wkrętaków
DE Schubladeneinlage / Schraubendrehersatz
RU Вклад к выдвижному ящику / Набор отвёрток
CZ Vložka do zásuvky / Zámečnické šroubováky
HU Fiókbetét / Csavarhúzó készlet
RO Adaos la sertar / Șurubelnițe de lăcătușerie
FR Module plastique pour servante avec tournevis
IT Tenone per l'armadio / Set di cacciaviti
ES Accesorio de cajón / Juego de destornilladores
CN 螺丝批托盘组套



3x75, 5x75, 4x100, 6x100; PH0x75, PH1x75, PH2x100 mm; S2;
 1.4x50, 2x50, 2.4x50 mm; PH00x50, PH0x50, PH1x50 mm; S2

YATO
YT-55455



8

EN Drawer insert / Go-through screwdrivers
PL Wkład do szuflady / Wkrętaki do pobijania
DE Schubladeneinlage / Schlagschrauber
RU Вклад к выдвижному ящику / Отвёртка-Било
CZ Vložka do zásuvky / Šroubovák s úderným koncem
HU Fiókbetét / Üthető csavarhúzó
RO Adaos la sertar / Șurubelniță pt. fixare
FR Module plastique pour servante / Allez - par tournevis
IT Tenone per l'armadio / Set di cacciaviti
ES Accesorio de cajón / Destornillador para dar golpes
CN 敲击螺丝批托盘组套



6x150, 8x200, PH2x150, PH3x200 mm; CrV

YATO
YT-55469



8

EN Drawer insert / Screwdriver set
 PL Wkład do szuflady / Komplet wkrętek
 DE Schubladeneinlage / Schraubendreheratz
 RU Вклад к выдвижному ящику / Набор отвёрток
 CZ Vložka do zásuvky / Zámečnické šroubováky
 HU Fiókbetét / Csavarhúzó készlet
 RO Adaos la sertar / Şurubelnițe de lăcătuşerie
 FR Module plastique pour servante avec trounevis
 IT Tenone per l'armadio / Set di cacciaviti
 ES Accesorio de cajón / Juego de destornilladores
 CN 绝缘螺丝批托盘组套

8 PCS S2



2.5x75, 4x100, 5.5x125, 6.5x150, PH1x80, PH2x100, PH3x150 mm; 1000V; S2;
 4x190 mm; 250V

YATO
 YT-55462 8

EN Drawer insert / Tool set
 PL Wkład do szuflady / Zestaw narzędziowy
 DE Schubladeneinlage / Werkzeug-Set
 RU Вклад к выдвижному ящику / Набор инструмента
 CZ Vložka do zásuvky / Sada nářadí
 HU Fiókbetét / Szerszámkészlet
 RO Adaos la sertar / Trusa de scule
 FR Module plastique pour servante / Coffret d'outillage
 IT Tenone per l'armadio / Set di utensili
 ES Accesorio de cajón / Juego de herramientas
 CN 套筒托盘工具组套

4 PCS CrV



3/4" (19.0 mm); (200 mm); CrV 6140;
 3/4" (19.0 mm); CrV 50BV30;
 3/4" (19.0 mm); (500 mm); CrV 50BV30;
 3/4" (19.0 mm); (500 mm); 72T; CrV 6140

YATO
 YT-55458 4

EN Drawer insert / Socket set
 PL Wkład do szuflady / Zestaw kluczy nasadowych
 DE Schubladeneinlage / Steckschlüsselsatz
 RU Вклад к выдвижному ящику / Торцовые ключи
 CZ Vložka do zásuvky / Klíče nástrčné
 HU Fiókbetét / Dugókulcsok
 RO Adaos la sertar / Duză cheie
 FR Module plastique pour servante avec set d'outillages
 IT Tenone per l'armadio chiave a bussola
 ES Accesorio de cajón / Llaves de cubo
 CN 套筒托盘组套

22 PCS CrV



3/8" (9.5 mm); 6, 7, 8, 9, 10, 11, 12, 13, 14, 15, 16, 17, 18, 19, 20, 21, 22 mm; CrV 50BV30;
 3/8" (9.5 mm); (76, 152.4 mm); CrV 50BV30;
 3/8" (9.5 mm); CrV 50BV30;
 3/8" (9.5 mm); (198 mm); CrV 50BV30;
 3/8" (9.5 mm); (200 mm); 72T; CrV 6140

YATO
 YT-5542 8

EN Drawer insert / Socket set
 PL Wkład do szuflady / Zestaw kluczy nasadowych
 DE Schubladeneinlage / Steckschlüsselsatz
 RU Вклад к выдвижному ящику / Торцовые ключи
 CZ Vložka do zásuvky / Klíče nástrčné
 HU Fiókbetét / Dugókulcsok
 RO Adaos la sertar / Duză cheie
 FR Module plastique pour servante avec set d'outillages
 IT Tenone per l'armadio chiave a bussola
 ES Accesorio de cajón / Llaves de cubo
 CN 套筒托盘组套

25 PCS CrV



1/4" (6.3 mm); 3.5, 4, 4.5, 5, 5.5, 6, 7, 8, 9, 10, 11, 12, 13, 14 mm; CrV 50BV30;
 1/4" (6.3 mm); 8, 10, 11, 12, 13 mm; CrV 50BV30;
 1/4" (6.3 mm); (50.8, 101.6 mm); CrV 6140;
 1/4" (6.3 mm); CrV 50BV30;
 1/4" (6.3 mm); (152.4 mm); CrV 50BV30;
 1/4" (6.3 mm); (155 mm); 72T; CrV 6140;
 1/4" (6.3 mm); (150 mm); CrV 50BV30

YATO
 YT-5541 8

EN Drawer insert / Socket set
 PL Wkład do szuflady / Zestaw kluczy nasadowych
 DE Schubladeneinlage / Steckschlüsselsatz
 RU Вклад к выдвижному ящику / Торцовые ключи
 CZ Vložka do zásuvky / Klíče nástrčné
 HU Fiókbetét / Dugókulcsok
 RO Adaos la sertar / Duză cheie
 FR Module plastique pour servante avec set d'outillages
 IT Tenone per l'armadio chiave a bussola
 ES Accesorio de cajón / Llaves de cubo
 CN 套筒托盘组套

24 PCS CrV



1/2" (12.7 mm); 10, 11, 12, 13, 14, 15, 16, 17, 18, 19, 20, 21, 22, 23, 24, 27, 30, 32 mm; CrV 50BV30;
 1/2" (12.7 mm); (127 mm); CrV 50BV30;
 1/2" (12.7 mm); CrV 50BV30;
 1/2" (12.7 mm); 16; 21 mm; CrV 50BV30;
 1/2" (12.7 mm); (255 mm); CrV 50BV30;
 1/2" (12.7 mm); (255 mm); 72T; CrV 6140

YATO
 YT-5537 4

EN Drawer insert / Screwdriver bits
 PL Wkład do szuflady / Końcówki śrubokrętowe
 DE Schubladeneinlage / Endstücke für Schraubenzieher
 RU Вклад к выдвижному ящику / Насадки для отвёрток
 CZ Vložka do zásuvky / Šroubováci nástavce
 HU Fiókbetét / Csavarhúzó bitek
 RO Adaos la sertar / Terminații pt. șurubelnițe
 FR Module plastique pour servante avec set d'embouts
 IT Tenone per l'armadio chiave punti di avvitamento
 ES Accesorio de cajón / Puntas para desarmadores
 CN 旋具头托盘组套

40 PCS S2



T20, T25, T30, T40, T45, T50, T55 (L=30 mm); T20, T25, T30, T40, T45, T50, T55 (L=75 mm); AISI S2;
 4, 5, 6, 7, 8, 10, 12 (L=30 mm); 4, 5, 6, 7, 8, 10, 12 (L=75 mm); AISI S2;
 M5, M6, M8, M10, M12 (L=30 mm); M5, M6, M8, M10, M12 (L=75 mm); AISI S2;
 1/2" (12.7 mm), 3/8" (9.5 mm)

YATO
 YT-5538 8

EN Drawer insert / Socket set
PL Wkład do szuflady / Zestaw kluczy nasadowych
DE Schubladeneinlage / Steckschlüsselsatz
RU Вклад к выдвижному ящику / Торцовые ключи
CZ Vložka do zásuvky / Klíče nástrčné
HU Fiókbetét / Dugókulcsok
RO Adaos la sertar / Duză cheie
FR Module plastique pour servante avec set d'outillages
IT Tenone per l'armadio chiave a bussola
ES Accesorio de cajón / Llaves de cubo
CN 套筒托盘工具组套

14
PCS CrV
50BV30



3/4" (19.0 mm): 19, 21, 22, 24, 27, 28, 30, 32, 34, 36, 41, 46, 50, 55 mm; CrV 50BV30

YATO
YT-55457 4

EN Drawer insert / Deep sockets
PL Wkład do szuflady / Klucze nasadowe długie
DE Schubladeneinlage / Tiefe Steckschlüssel
RU Вклад к выдвижному ящику / Торцовые глубокие ключи
CZ Vložka do zásuvky / Klíče nástrčné hluboké
HU Fiókbetét / Hosszú dugókulcsok
RO Adaos la sertar / Prize de curent adânci
FR Module plastique pour servante avec set de douilles
IT Tenone per l'armadio chiave a bussola lunga
ES Accesorio de cajón / Llaves de cubo profundo
CN 六角长套筒托盘组套

14
PCS CrV
50BV30



1/2" (12.7 mm): 8, 9, 10, 11, 12, 13, 14, 15, 16, 17, 18, 19, 20, 21 mm (L=76 mm); CrV 50BV30

YATO
YT-5539 8

EN Drawer insert / Tool set
PL Wkład do szuflady / Zestaw narzędziowy
DE Schubladeneinlage / Werkzeug-Set
RU Вклад к выдвижному ящику / Набор инструмента
CZ Vložka do zásuvky / Sada nářadí
HU Fiókbetét / Szerszámkészlet
RO Adaos la sertar / Trusa de scule
FR Module plastique pour servante / Coffret d'outillage
IT Tenone per l'armadio / Set di utensili
ES Accesorio de cajón / Juego de herramientas
CN 旋具托盘组套

31
PCS CrV S2



1/2" (12.7 mm): E10, E12, E14, E16, E18, E20 (L=38 mm); CrV 50BV30;

1/2" (12.7 mm): 10 mm; CrV 6150;

M5, M6, M8, M10, M12 (L=30 mm); AISI S2;

2, 2.5, 3, 4, 5, 6, 7, 8, 10, 12 mm; CrV 6150;

T10, T15, T20, T25, T27, T30, T40, T45, T50; CrV 6150

YATO
YT-55451 8

EN Drawer insert / Hammers and chisels
PL Wkład do szuflady / Młotki i przecinaki
DE Schubladeneinlage / Hämmer und Meißel
RU Вклад к выдвижному ящику / Молотки и зубила
CZ Vložka do zásuvky / Kladiva, dláta a sekáče
HU Fiókbetét / Kalapácsok és hidegvágók
RO Adaos la sertar / Ciocane și dalți
FR Module plastique pour servante avec marteaux et burins
IT Tenone per l'armadio martelli e scalpelli
ES Accesorio de cajón / Martillos y cinceles
CN 锤头凿子托盘组套

5
PCS CrV



300 g (L=300 mm);

40 mm (L=350 mm);

10x8x142 mm, 12x10x152 mm, 16x13x172 mm; CrV

YATO
YT-5540 8

EN Drawer insert / Measuring tools
PL Wkład do szuflady / Narzędzia miernicze
DE Schubladeneinlage / Messwerkzeuge
RU Вклад к выдвижному ящику / Измерительные приборы
CZ Vložka do zásuvky / Měřeni
HU Fiókbetét / Mérészközök
RO Adaos la sertar / Instrumente de măsură
FR Module plastique pour servante / Outils de mesurage
IT Tenone per l'armadio / Strumenti di misura
ES Accesorio de cajón / Instrumentos de medición
CN 量具托盘组套

5
PCS AI SS ABS



300 mm; AI;

0-150 mm; SS;

2 m;

3m x 16 mm; ABS;

0.02-1.00 mm

YATO
YT-55474 8

EN Drawer insert / Steel file set
PL Wkład do szuflady / Pilniki do metalu
DE Schubladeneinlage / Feilensatz
RU Вклад к выдвижному ящику / Набор напильников
CZ Vložka do zásuvky / Pilníky na kov
HU Fiókbetét / LLakatos reszelő készlet
RO Adaos la sertar / Pile de lăcătușerie
FR Module plastique pour servante / Set de limes à métal
IT Tenone per l'armadio / Set di lime per metallo
ES Accesorio de cajón / Juego de limas para metal
CN 锉刀托盘组套

5
PCS T12



#2, 200 mm; T12;

#2, 200 mm; T12;

#2, 200 mm; T12;

#2, 200 mm; T12;

#2, 200 mm; T12

YATO
YT-55453 8

EN Drawer insert / Hand riveter with rivets
 PL Wkład do szuflady / Nitownica ręczna z głowicą obrotową
 DE Schubladeneinlage / Blindnietzange
 RU Вклад к выдвижному ящику / Ручной заклёпочник
 CZ Vložka do zásuvky / Ruční nýtačnicka
 HU Fiókbetét / Kézi popszegecsőhúzó
 RO Adaos la sertar / Pdeşte pt. popnituri
 FR Module plastique pour servante / Riveteuse a main
 IT Tenone per l'armadio / Rivettatrice manuale girevole
 ES Accesorio de cajón / Remachadora de mano
 CN 拉柳枪托盘组套



2.4, 3.2, 4.0, 4.8 mm; CrV;
 9.6x3.2, 9.6x4.0, 12.7x4.0, 9.6x4.8, 12.7x4.8 mm; Al

YATO **YT-55466** 8

EN Drawer insert / Tool set
 PL Wkład do szuflady / Zestaw narzędziowy
 DE Schubladeneinlage / Werkzeug-Set
 RU Вклад к выдвижному ящику / Набор инструмента
 CZ Vložka do zásuvky / Sada nářadí
 HU Fiókbetét / Szerszámkészlet
 RO Adaos la sertar / Trusa de scule
 FR Module plastique pour servante / Coffret d'outillage
 IT Tenone per l'armadio / Set di utensili
 ES Accesorio de cajón / Juego de herramientas
 CN 工具托盘组套



1" (25 mm), L=330 mm; CrV;
 250 mm; CrMo;
 2.4, 3.2, 4.0, 4.8 mm;
 9.6x3.2, 9.6x4.0, 12.7x4.8 mm; Al

YATO **YT-55478** 8

EN Drawer insert / Automotive workshop tools
 PL Wkład do szuflady / Zestaw narzędzi warsztatowych
 DE Schubladeneinlage / Kfz-werkzeuge
 RU Вклад к выдвижному ящику / Автомобильные инструменты
 CZ Vložka do zásuvky / Auto nářadí
 HU Fiókbetét / Autóipari szerszámok
 RO Adaos la sertar / Scule auto
 FR Module plastique pour servante / Outils de réparation automobile
 IT Tenone per l'armadio / Set attrezzi officina
 ES Accesorio de cajón / Herramientas de automoción
 CN 轮胎修理工具托盘组套



200 mm;
 135 mm;
 300, 400, 500 mm; CrV

YATO **YT-55477** 4

EN Drawer insert / Automotive workshop tools
 PL Wkład do szuflady / Zestaw narzędzi warsztatowych
 DE Schubladeneinlage / Kfz-werkzeuge
 RU Вклад к выдвижному ящику / Автомобильные инструменты
 CZ Vložka do zásuvky / Auto nářadí
 HU Fiókbetét / Autóipari szerszámok
 RO Adaos la sertar / Scule auto
 FR Module plastique pour servante / Outils de réparation automobile
 IT Tenone per l'armadio / Set attrezzi officina
 ES Accesorio de cajón / Herramientas de automoción
 CN 轮胎修理工具托盘组套



1/2" (12.7 mm) x 5/16" (7.9 mm); CrV 6150;
 8 mm (L=35 mm); 8 mm (L=75 mm); CrV 6150;
 PH3 (L=35 mm); PH1, PH2, PH3 (L=75 mm); CrV 6150;
 12-38 mm; CrV 6150;
 3" (75 mm); CrV;
 82 mm; CrV

YATO **YT-55476** 4

EN Drawer insert / Tool set
 PL Wkład do szuflady / Zestaw narzędziowy
 DE Schubladeneinlage / Werkzeug-Set
 RU Вклад к выдвижному ящику / Набор инструмента
 CZ Vložka do zásuvky / Sada nářadí
 HU Fiókbetét / Szerszámkészlet
 RO Adaos la sertar / Trusa de scule
 FR Module plastique pour servante / Coffret d'outillage
 IT Tenone per l'armadio / Set di utensili
 ES Accesorio de cajón / Juego de herramientas
 CN 工具托盘组套



140 mm; SS;
 200 mm; 3Cr13;
 19 mm x 20 mm;
 4x190 mm; 250 V;
 1, 1.5, 2, 2.5, 3, 3.5, 4, 4.5, 5, 5.5, 6, 6.5, 7, 7.5, 8, 8.5, 9, 9.5, 10 mm; HSS 6542

YATO **YT-55471** 8

EN Drawer insert / Taps and die set
 PL Wkład do szuflady / Zestaw narzzynek i gwintowników
 DE Schubladeneinlage / Gewindeschneidwerkzeug-Satz
 RU Вклад к выдвижному ящику / Набор плашек и метчиков
 CZ Vložka do zásuvky / Souprava závitníků a kruhových závitových čelistí
 HU Fiókbetét / Menetfúró és menetvágó készlet
 RO Adaos la sertar / Set de tarozi și fi liere
 FR Module plastique pour servante / Pince a riveter avec embouts
 IT Tenone per l'armadio / Set di filiera a maschi
 ES Accesorio de cajón / Juego de machos de roscar y cojinetes
 CN 丝锥板牙托盘组套



M3x0.5 x3, M4x0.7x3, M5x0.8 x3, M6x1.0 x3, M7x1.0 x3, M8x1.25, M10x1.5, M12x1.75; HSS M2;
 M3x0.5, M4x0.7, M5x0.8, M6x1.0, M7x1.0, M8x1.25, M10x1.5, M12x1.75; HSS M2;
 M7-M9;
 M3-M12;
 0.5 - 1.75 mm; 27G; 28G

YATO **YT-55465** 8

EN Drawer insert
PL Wkład do szuflady
DE Schubladeneinlage
RU Вклад к выдвижному ящику
HU Fiókbetét

RO Adaos la sertar
FR Module plastique pour servante
IT Tenone per l'armadio
ES Accesorio de cajón
CN 吸塑盒



For YT-5531
Dla YT-5531

YATO	
YT-55311	5/30



For YT-5532
Dla YT-5532

YATO	
YT-55321	5/30



For YT-5533
Dla YT-5533

YATO	
YT-55331	5/30



For YT-5534
Dla YT-5534

YATO	
YT-55341	5/30

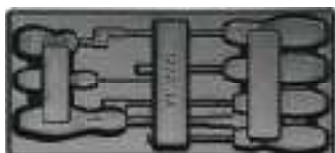

For YT-5535
Dla YT-5535

YATO	
YT-55351	5/30

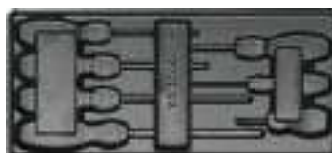

For YT-5536
Dla YT-5536

YATO	
YT-55361	5/30



For YT-5537
Dla YT-5537

YATO	
YT-55371	5/30

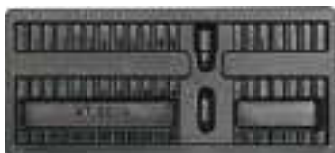

For YT-5538
Dla YT-5538

YATO	
YT-55381	5/30

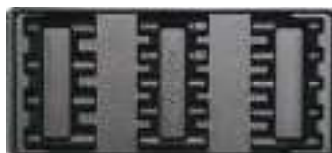

For YT-5539
Dla YT-5539

YATO	
YT-55391	5/30



For YT-5540
Dla YT-5540

YATO	
YT-55401	5/30

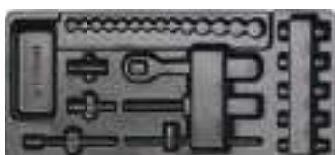

For YT-5541
Dla YT-5541

YATO	
YT-55411	5/30



For YT-5542
Dla YT-5542

YATO	
YT-55421	5/30



For YT-5544
Dla YT-5544

YATO	
YT-55479	5/30

EN Legs for workbench, long
PL Nogi do stołu warsztatowego, długie
DE Beine für Werkbank, lange
RU Ножи для верстака, длинные
CZ Nohy k pracovnímu stolu, dlouhé
HU Lábak munkapadhoz
RO Picioare pt. banc de lucru, lungi
FR Jambes pour table d'atelier
IT Gambe del tavolo piedi del banco da lavoro
ES Patas para banco de trabajo, largas
CN 工作台长桌腿

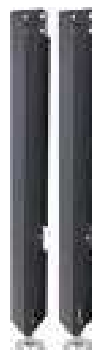

2
PCS
140
cm

For YT-08920
Dla YT-08920

YATO	L [mm]	
YT-08921	1400	2

EN Holders for workshop box
PL Uchwyty do montażu szafki warsztatowej
DE Halterungen für die Montage eines Werkstattschranks
RU Крепеж для рабочего шкафа
CZ Montážní držáky dílenské skříňky
HU Műhelyszekrény tartó
RO Suporturi pt. montarea dulapurii de atelier
FR Porte-placard d'atelier
IT Staffa di montaggio per armadio portautensili
ES Elementos de fijación para instalación de cajón de taller
CN 高档工作台吊柜架



2
PCS
500x100
x350
mm

For YT-08920, YT-09152
Dla YT-08920, YT-09152

YATO	Dimensions / Wymiary [mm]	
YT-08922	500x100x350	2

- EN Connection steel pipes set
 PL Rury montażowe
 DE Anschluss Stahlrohre Gesetzt
 RU Стальная труба монтаж
 CZ Ocelové trubky
 HU Acélcsovek
 RO Tevi din oțel
 FR Tuyaux en acier
 IT Set di montaggio per tabella utensili
 ES Tubos de acero
 CN 高档工具柜定位杆





For YT-09152, YT-09155 + YT-0902, YT-0903, YT-0904
 Dla YT-09152, YT-09155 + YT-0902, YT-0903, YT-0904

YATO 	L [mm]	Ø [mm]	
YT-09071	450	28	20

- EN Double project center backwall
 PL Tablica narzędziowa
 DE Werkzeugwand
 RU Доска инструмент
 CZ Držáky na nářadí
 HU Szerszámtartó fal akasztókkal
 RO Suport perete scule
 FR Mur d'outil
 IT La tabella utensili
 ES Panel de herramientas
 CN 高档工具车挂板



For YT-0902, YT-0903, YT-09031, YT-0904, YT-55290, YT-55292, YT-55293, YT-5530
 Dla YT-0902, YT-0903, YT-09031, YT-0904, YT-55290, YT-55292, YT-55293, YT-5530

YATO 	Dimensions / Wymiary [mm]	
YT-09072	652x610x55	1

- EN Compartmented shelf and paper roll holder
 PL Półka z uchwytem na papier
 DE Werkstattwagenablage mit Papierrollehalter
 RU Полка с держателем для бумаги
 CZ Police s úchytem na papír
 HU Kiegészítő polc és papírrölni tartó funkcióval
 RO Compartiment pt. dulap si suport hartie
 FR Support rouleau papier
 IT Mensola portarotoli carta
 ES Estante con sujetapapel
 CN 托架



For YT-0902, YT-0903, YT-0904, YT-0905
 Dla YT-0902, YT-0903, YT-0904, YT-0905

YATO 	Dimensions / Wymiary [mm]	
YT-0907	305x305x145	4

- EN Dustbin
 PL Pojemnik na odpady
 DE Abfalleimer
 RU Мусорный ящик
 CZ Zásobník na odpad
 HU Szemétkosár
 RO Lada de gunoi
 FR Poubelle
 IT Contenitore di rifiuti
 ES Cubo de basura
 CN 废品箱





For YT-0902, YT-0903, YT-0904, YT-0905
 Dla YT-0902, YT-0903, YT-0904, YT-0905

YATO 	Dimensions / Wymiary [mm]	
YT-0908	300x300x190	4

- EN Separate board for drawer
 PL Przegroda do szafki
 DE Trennsteg für Werkstatt-Wagen-Schublade
 RU Перегородки для ящика
 CZ Půlhřádka do police
 HU Több rekeszes tálcá
 RO Sertar separat de masura mica
 FR Cloison tiroir court
 IT Separatore per armadio
 ES Separador para armario
 CN 抽屉分隔板



For YT-0902, YT-0903, YT-0904, YT-0905
 Dla YT-0902, YT-0903, YT-0904, YT-0905

YATO 	Dimensions / Wymiary [mm]	
YT-0910	391x58x4	24
YT-0911	391x128x4	24

EN Magnetic towel holder
PL Magnetyczny uchwył na ręczniki
DE Magnetischer Rollenhalter
RU Магнитная вешалка для бумаги
CZ Držákú magnetických papírových ručníků
HU Mágneses papírtörő állvány

RO Suportú magnetici pt. prosoape
FR Porte-serviettes en papier magnétique
IT Portasciugamani magnetico
ES Magnético de papel toallero
CN 磁性纸巾挂架

min
230
mm

ADJUSTABLE
RANGE
REGULOWANY
ROZSTAW



SCRATCH
PROTECTION
OCHRONA
PRZED
ZARYSOWANIEM



YATO

YT-08680



24

EN Magnetic shelf
PL Półka magnetyczna
DE Magnetische Ablage
RU Магнитная полка для тележки
CZ Magnetický regál pro nářadí
HU Mágneses polc szérszámokcsikhoz

RO Cutie magnetice pt. depozitare
FR Magnétique plat
IT Mensola magnetica
ES Soporte de almacenamiento magnético
CN 磁性工具盒

215x120
x130
mm



SCRATCH
PROTECTION
OCHRONA
PRZED
ZARYSOWANIEM



YATO

YT-08681



10

EN Magnetic tool tray set
PL Zestaw półek magnetycznych
DE Magnetische Werkzeugablage Set

RU Набор магнитных полок для тележки
CZ Sada magnetických poliček
HU Mágneses polc készlet

RO Cutii magnetice pt. depozitare
FR Magnétique étagères set
IT Set di ripiani magnetici

ES Juego de estantes magnéticos
CN 磁性工具盘

4
PCS



SCRATCH
PROTECTION
OCHRONA
PRZED
ZARYSOWANIEM

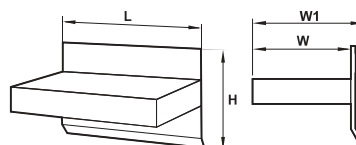

	L (mm)	H (mm)	W (mm)	W1 (mm)
	310	120	115	125
	270	120	115	125
	210	120	115	125
	155	120	115	125

YATO

YT-08682



6

EN Magnetic hooks set
PL Zestaw haczyków magnetycznych
DE Magnetische Haken Set
RU Набор магнитных крючков для тележки
CZ Sada magnetických háčků
HU Mágneses kampók halmaza

RO Set de cârlige magnetice
FR Ensemble de crochets magnétiques
IT Set di ganci magnetici
ES Conjunto de ganchos magnéticos
CN 磁性挂钩

10
PCS

35
mm

30
mm



SCRATCH
PROTECTION
OCHRONA
PRZED
ZARYSOWANIEM



YATO

YT-08690



12/48

EN Hook for panel
PL Haczyki do panelu perforowanego
DE Haken für perforierte Wände
RU Гачки для стенки с перфорацией
CZ Háčky pro stěnu s perforací
HU Horgok perforált panelhez

RO Cârlige pt. panou perforate
FR Crochets pour le mur avec perforation
IT Ganci per pannelli forati
ES Ganchos para pared con perforación
CN 挂钩

5
PCS

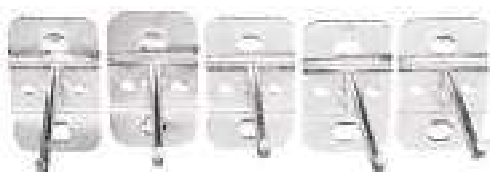

For YT-08936
Dla YT-08936



YATO

YT-08937



20

EN Service utility key
PL Klucz do szafek serwisowych
DE Schallschrank-Schlüssel für Gängige Schränke
RU Ключ для сервисных шкафов
CZ Klíč na rozvodné skříně
HU Kapsolőszekrény kulcs
RO Cheie universală pt. panou de comanda
FR Clés universelles pour armoires de commande
IT Chiave universale a croce per armadietti
ES Llaves para armarios de control
CN 多用阀门钥匙

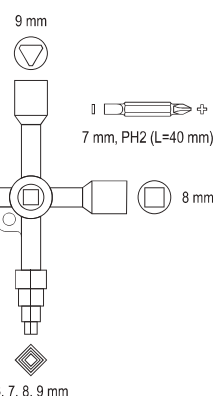

YATO

YT-66700







20/120

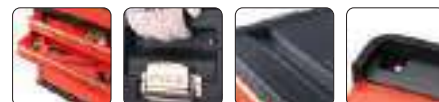

- | | | |
|--------------------------|------------------------|---------------------------|
| EN Tool box | CZ Skříňka na nářadí | IT Casseta degli attrezzi |
| PL Skrzynka narzędziowa | HU Szerszámcsédes láda | ES Caja de herramientas |
| DE Werkzeugkasten | RO Cutie de scule | CN 一抽屉工具组套 |
| RU Инструментальный ящик | FR Boîte à outils | |



YATO 	Drawer quantity / Liczba szuflad	
YT-09108	1	2

YATO 	Drawer quantity / Liczba szuflad	
YT-09107	2	2

- | | | |
|----------------------------------|-----------------------|-------------------------|
| EN Tool trolley | CZ Vozík na nářadí | IT Armadio per utensili |
| PL Wózek narzędziowy 3-częściowy | HU Szerszám kocsi | ES Herramienta carro |
| DE Werkzeugkasten | RO Troler pt. scule | CN 拉杆式工具箱 |
| RU Тележка инструментальная | FR Servante d'atelier | |



YATO 		
YT-09102		1

YATO 		
YT-09101		1

EN Tool trolley
PL Wózek narzędziowy 3-częściowy z narzędziami
DE Werkzeugkasten
RU Телeжка инструментальная
CZ Vozík na nářadí
HU Szerszám kocsi
RO Troler cu scule
FR Servante d'atelier

IT Armadio per utensili
ES Herramienta carro
CN 手推式工具箱



Drawer 1 / Szuflada 1

- 1/2" (12.7 mm): 8, 10, 12, 13, 14, 15, 16, 17, 18, 19, 20, 21, 22 mm; CrV 50BV30;
- 1/2" (12.7 mm): (127 mm); CrV 50BV30;
- 1/2" (12.7 mm); (255 mm); T2T; CrV 6140;
- 3x75, 6x100; PH0x75, PH2x100 mm; S2;
- 215 mm;
- 1/4" (6.3 mm): 3.0, 3.5, 4.0, 5.5, 6.5 mm (L=25 mm); S2;
- 1/4" (6.3 mm): PH0, PH1, PH2, PH3 (L=25 mm); S2;
- 1/4" (6.3 mm): PZ0, PZ1, PZ2, PZ3 (L=25 mm); S2;
- 1/4" (6.3 mm): T10, T15 (L=25 mm); S2;
- 1/4" (6.3 mm): 2, 3, 4, 5, 6 mm (L=25 mm); S2;
- 1/4" (6.3 mm): 5, 6, 7, 8 x2, 9, 10, 11, 12, 13 mm

Drawer 2 / Szuflada 2

- 8, 10, 12, 13, 14, 15, 16, 17, 18, 19, 21 mm; CrV;
- 18 mm; SK5;
- 18 mm; SK5;
- 3 m x 16 mm

Drawer 3 / Szuflada 3

- 180 mm;
- 160 mm;
- 200 mm;
- 300 mm; 16-38 mm;
- 2, 2.5, 3, 4, 5, 6, 7, 8, 10, 12 mm; CrV 6150

78
PCS
3
TRAYS
TACE

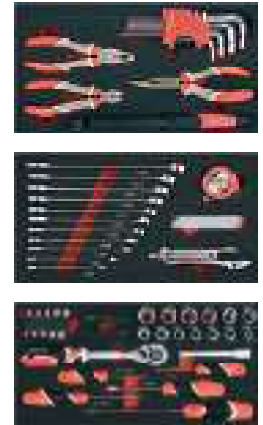

YATO	YT-09104	1
-------------	----------	---

EN Hermetic toolbox
PL Walizka narzędziowa hermetyczna
DE Hermetischer Werkzeugkoffer
RU Герметичный инструментальный чемодан
CZ Kufř na nářadí hermetický
HU Hermetikus szerszámosláda
RO Cutie scule ermetica
FR Valise à outils étanche
IT Valigetta portautensili a tenuta stagna
ES Caja de herramientas hermetica
CN 安全箱

232x192
x111
mm

DECOMPRESSION
VALVE
ZAWÓR
DEKOMPRESYJNY



SHOCK-
PROOF
ODPORNA
NA WSTRZÁSY

FOAM
INSERT
WKŁAD
GĄBKOWY

IP55

PP



YATO	External dimensions / Wymiary zewnętrzne [mm]	Internal dimensions / Wymiary wewnętrzne [mm]	
YT-08900	232x192x111	208x144x92	12

EN Hermetic toolbox
PL Walizka narzędziowa hermetyczna
DE Hermetischer Werkzeugkoffer
RU Герметичный инструментальный чемодан
CZ Kufř na nářadí hermetický
HU Hermetikus szerszámosláda
RO Cutie scule ermetica
FR Valise à outils étanche
IT Valigetta portautensili a tenuta stagna
ES Caja de herramientas hermetica
CN 安全箱

270x246
x124
mm

DECOMPRESSION
VALVE
ZAWÓR
DEKOMPRESYJNY



SHOCK-
PROOF
ODPORNA
NA WSTRZÁSY

FOAM
INSERT
WKŁAD
GĄBKOWY

IP55

PP



YATO	External dimensions / Wymiary zewnętrzne [mm]	Internal dimensions / Wymiary wewnętrzne [mm]	
YT-08901	270x246x124	235x181x105	8

EN Hermetic toolbox
PL Walizka narzędziowa hermetyczna
DE Hermetischer Werkzeugkoffer
RU Герметичный инструментальный чемодан
CZ Kufř na nářadí hermetický
HU Hermetikus szerszámosláda
RO Cutie scule ermetica
FR Valise à outils étanche
IT Valigetta portautensili a tenuta stagna
ES Caja de herramientas hermetica
CN 安全箱

339x295
x152
mm

DECOMPRESSION
VALVE
ZAWÓR
DEKOMPRESYJNY



SHOCK-
PROOF
ODPORNA
NA WSTRZÁSY

FOAM
INSERT
WKŁAD
GĄBKOWY

IP55

PP



YATO	External dimensions / Wymiary zewnętrzne [mm]	Internal dimensions / Wymiary wewnętrzne [mm]	
YT-08902	345x295x152	300x225x132	4

EN Hermetic toolbox
PL Walizka narzędziowa hermetyczna
DE Hermetischer Werkzeugkoffer
RU Герметичный инструментальный чемодан
CZ Kufř na nářadí hermetický
HU Hermetikus szerszámosláda
RO Cutie scule ermetica
FR Valise à outils étanche
IT Valigetta portautensili a tenuta stagna
ES Caja de herramientas hermetica
CN 安全箱

406x330
x174
mm

DECOMPRESSION
VALVE
ZAWÓR
DEKOMPRESYJNY



SHOCK-
PROOF
ODPORNA
NA WSTRZÁSY

FOAM
INSERT
WKŁAD
GĄBKOWY

IP55

PP



YATO	External dimensions / Wymiary zewnętrzne [mm]	Internal dimensions / Wymiary wewnętrzne [mm]	
YT-08903	406x330x174	371x258x152	2

EN Hermetic toolbox
PL Walizka narzędziowa hermetyczna
DE Hermetischer Werkzeugkoffer
RU Герметичный инструментальный чемодан
CZ Kufř na nářadí hermetický
HU Hermetikus szerszámosláda
RO Cutie scule ermetica
FR Valise à outils étanche
IT Valigetta portautensili a tenuta stagna
ES Caja de herramientas hermetica
CN 安全箱

470x357
x176
mm

DECOMPRESSION
VALVE
ZAWÓR
DEKOMPRESYJNY



SHOCK-
PROOF
ODPORNA
NA WSTRZÁSY

FOAM
INSERT
WKŁAD
GĄBKOWY

IP55

PP



YATO	External dimensions / Wymiary zewnętrzne [mm]	Internal dimensions / Wymiary wewnętrzne [mm]	
YT-08904	470x357x176	425x284x155	2

EN Hermetic toolbox
PL Walizka narzędziowa hermetyczna
DE Hermetischer Werkzeugkoffer
RU Герметичный инструментальный чемодан
CZ Kufř na nářadí hermetický
HU Hermetikus szerszámosláda
RO Cutie scule ermetica
FR Valise à outils étanche
IT Valigetta portautensili a tenuta stagna
ES Caja de herramientas hermetica
CN 安全箱

569x425
x215
mm

DECOMPRESSION
VALVE
ZAWÓR
DEKOMPRESYJNY



SHOCK-
PROOF
ODPORNA
NA WSTRZÁSY

FOAM
INSERT
WKŁAD
GĄBKOWY

IP55

PP



YATO	External dimensions / Wymiary zewnętrzne [mm]	Internal dimensions / Wymiary wewnętrzne [mm]	
YT-08906	569x425x215	505x350x140	2

EN Hermetic toolbox
 PL Walizka narzędziowa hermetyczna
 DE Hermetischer Werkzeugkoffer
 RU Герметичный инструментальный чемодан
 HU Hermetikus szerszámosláda

RO Cutie scule ermetica
 FR Valise à outils étanche
 IT Valigetta portautensili a tenuta stagna
 ES Caja de herramientas hermetica
 CN 安全箱

559x351
x229
mm

ø 60 mm

DECOMPRESSION VALVE ZAWÓR DEKOMPRESYJNY

SHOCK-PROOF ODPOORNÁ NA WSTRZĄSY

FOAM INSERT WKŁAD GĄBKOWY

IP55

PP



YATO	External dimensions / Wymiary zewnętrzne [mm]	Internal dimensions / Wymiary wewnętrzne [mm]	
YT-08905	559x351x229	501x279x193	1

EN Hermetic toolbox
 PL Walizka narzędziowa hermetyczna
 DE Hermetischer Werkzeugkoffer
 RU Герметичный инструментальный чемодан
 CZ Kufr na nářadí hermetický
 HU Hermetikus szerszámosláda
 RO Cutie scule ermetica
 FR Valise à outils étanche
 IT Valigetta portautensili a tenuta stagna
 ES Caja de herramientas hermetica
 CN 安全箱

430x244
x341
mm

DECOMPRESSION VALVE ZAWÓR DEKOMPRESYJNY

SHOCK-PROOF ODPOORNÁ NA WSTRZĄSY

FOAM INSERT WKŁAD GĄBKOWY

IP55

PP



YATO	External dimensions / Wymiary zewnętrzne [mm]	Internal dimensions / Wymiary wewnętrzne [mm]	
YT-08907	430x244x341	344x146x297	2

EN Cantilever tool box
 PL Skrzynka narzędziowa
 DE Werkzeugkoffer
 RU Инструментальный ящик
 CZ Nástrojová skříňka
 HU Szerszámosláda

RO Cutie pt. scule
 FR Boîte à outils
 IT Cassetta degli attrezzi
 ES Caja de herramientas
 CN 手提工具箱

360x150
x115
mm



YATO	Dimensions / Wymiary [mm]	
YT-0882	360x150x115	4

EN Cantilever tool box
 PL Skrzynka narzędziowa
 DE Werkzeugkoffer
 RU Инструментальный ящик
 CZ Nástrojová skříňka
 HU Szerszámosláda

RO Cutie pt. scule
 FR Boîte à outils
 IT Cassetta degli attrezzi
 ES Caja de herramientas
 CN 手提工具箱



YATO	Dimensions / Wymiary [mm]	
YT-0883	428x180x180	1

EN Cantilever tool box
 PL Skrzynka narzędziowa
 DE Werkzeugkoffer
 RU Инструментальный ящик
 CZ Nástrojová skříňka
 HU Szerszámosláda

RO Cutie pt. scule
 FR Boîte à outils
 IT Cassetta degli attrezzi
 ES Caja de herramientas
 CN 工具箱



YATO	Dimensions / Wymiary [mm]	
YT-0884	460x200x180	1

EN Cantilever tool box
 PL Skrzynka narzędziowa
 DE Werkzeugkoffer
 RU Инструментальный ящик
 CZ Nástrojová skříňka
 HU Szerszámosláda
 RO Cutie pt. scule
 FR Boîte à outils
 IT Cassetta degli attrezzi
 ES Caja de herramientas
 CN 工具箱

460x200
x225
mm



YATO	Dimensions / Wymiary [mm]	
YT-0885	460x200x225	1

EN Cantilever tool box
 PL Skrzynka narzędziowa
 DE Werkzeugkoffer
 RU Инструментальный ящик
 CZ Nástrojová skříňka
 HU Szerszámosláda
 RO Cutie pt. scule
 FR Boîte à outils
 IT Cassetta degli attrezzi
 ES Caja de herramientas
 CN 手提工具箱



YATO	Dimensions / Wymiary [mm]	
YT-0886	510x220x240	1

EN Cantilever tool box
 PL Skrzynka narzędziowa
 DE Werkzeugkoffer
 RU Инструментальный ящик

CZ Nástrojová skříňka
 HU Szerszámosláda
 RO Cutie pt. scule
 FR Boîte à outils

IT Cassetta degli attrezzi
 ES Caja de herramientas
 CN 工具箱



2x



3x



4x

YATO	Drawer quantity / Liczba szuflad	Dimensions / Wymiary [mm]	
YT-08872	2	218x255x520	1

YATO	Drawer quantity / Liczba szuflad	Dimensions / Wymiary [mm]	
YT-08873	3	218x300x520	1

YATO	Drawer quantity / Liczba szuflad	Dimensions / Wymiary [mm]	
YT-08874	4	218x360x520	1

EN Tool box with tools
PL Skrzynka z narzędziami
DE Werkzeugkoffer
RU Инструментальный ящик
CZ Nástrojová skříňka
HU Szerszámosláda
RO Cutie pt. scule
FR Boîte d'outils
IT Cassetta degli attrezzi
ES Caja de herramientas
CN 工具箱套



62 PCS
1/2" 12.7mm
CrV 50BV30
CrV 6150
CrV 6140
72T
AS-DRIVE
- +

1/2" (12.7 mm): 10, 11, 12, 13, 14, 15, 16, 17, 18, 19, 20, 21, 22, 23, 24 mm (L=38 mm); 27, 30, 32 mm (L=42 mm); CrV 50BV30;
1/2" (12.7 mm): (76, 127, 254 mm); CrV 50BV30;
1/2" (12.7 mm); CrV 50BV30;
1/2" (12.7 mm): 21 mm; CrV 50BV30;
1/2" (12.7 mm): (255 mm); CrV 50BV30;
1/2" (12.7 mm); 72T; CrV 6140;
1/2" (12.7 mm); (450 mm); CrV 50BV30;
6, 7, 8, 9, 10, 11, 12, 13, 14, 15, 16, 17, 18, 19, 20, 21, 22, 24 mm; CrV;
6x100, 6x150, 8x200 mm; CrV 6150;
PH2x100, PH3x150, PH3x200 mm; CrV 6150;
180 mm; CrV;
160 mm; CrV;
160 mm; CrV;
1.5, 2, 2.5, 3, 4, 5, 6, 8, 10 mm; CrV 6150



YATO	Dimensions / Wymiary [mm]	
YT-3895	475x230x365	1

EN Tool box with tools
PL Skrzynka z narzędziami
DE Werkzeugkoffer
RU Инструментальный ящик
CZ Nástrojová skříňka
HU Szerszámosláda

RO Cutie pt. scule
FR Boîte d'outils
IT Cassetta degli attrezzi
ES Caja de herramientas
CN 工具箱套



80 PCS
460x220x245 mm
1/2" 12.7mm
1/4" 6.3mm
CrV 50BV30
CrV 6140
S2
72T
AS-DRIVE
- +

1/2" (12.7 mm): 10, 11, 12, 13, 14, 15, 17, 19 mm (L=38 mm);
1/4" (6.3 mm): 5, 6, 7, 8, 9, 10, 11, 12, 13 mm (L=25 mm); CrV 50BV30;
1/2" (12.7 mm): 21 mm; CrV 50BV30;
1/2" (12.7 mm); (255 mm); 72T; CrV 6140;
1/4" (6.3 mm); (150 mm); CrV 50BV30;
1/4" (6.3 mm) x 1/4" (6.3 mm); CrV 50BV30;
1/4" (6.3 mm): 3 x2, 4 x2, 5 x2, 5.5 x2, 6 x2 mm (L=25 mm); AISI S2;
1/4" (6.3 mm): PH0, PH1 x2, PH2 x2, PH3 (L=25 mm); AISI S2;
1/4" (6.3 mm): PZ0, PZ1 x2, PZ2 (L=25 mm); AISI S2;
6, 7, 8, 9, 10, 11, 12, 13, 14, 15, 17, 19 mm; CrV;
5x75 mm, 6x100 mm, 8x150 mm, PH1x75 mm, PH2x100 mm; S2;
180 mm; CrV;
160 mm; CrV;
160 mm; CrV;
250 mm;
300 g;
18 mm; SK2;
18x0.5 mm; SK2;
1.5, 2, 2.5, 3, 4, 5, 5.5, 6 mm; T10, T15, T20, T25, T27, T30, T40; CrV



YATO	Dimensions / Wymiary [mm]	
YT-38951	460x220x245	1

EN Oil filter chain wrench
 PL Klucz łańcuchowy do filtrów oleju
 DE Ölfilter-Kettenschlüssel
 RU Цепной ключ для масляных фильтров
 CZ Klíč na olejový filtr řetězový
 HU Olajszűrő leszedő láncos
 RO Cheie cu lanț pt. filtre ulei
 FR Clé à chaîne pour filtre à huile
 IT Chiave a catena per filtri olio
 ES Llave de cadena para filtros de aceite
 CN 过滤器链式扳手



1/2"
12.7mm
DOUBLE CHAIN
PODWÓJNY
ŁAŃCUCH
CrV

YATO	Ø [mm]	
YT-08253	60-115	5/30
YT-08254	75-170	5/30

EN Oil filter wrench
 PL Klucz do filtra oleju
 DE Ölfilterschlüssel
 RU Съёмник масляного фильтра
 CZ Klíč na olejový filtr
 HU Olajszűrő leszedő
 RO Cheie pt. filtru de ulei
 FR Clé pour filtre à huile
 IT Chiave per filtro olio
 ES Llave para filtro de aceite
 CN 滤清器扳手



1/2"
12.7mm
CrMo

YATO	Ø [mm]	
YT-08235	60-80	20
YT-08236	80-105	20

EN Self-adjustable oil filters pliers
 PL Szczypce samonastawne do filtrów oleju
 DE Selbsteinstellende Zangen für Ölfilter
 RU Саморегулирующиеся клещи для масляного фильтра
 CZ Samonastavovací kleště pro olejové filtry
 HU Önbeállító olajszűrő leszedő fogó
 RO Cheie ajustabilă filtru ulei
 FR Pince à filtre à huile auto-ajustable
 IT Pinza auto-regolante per filtri d'olio
 ES Pinzas autoajustables para filtros de aceite
 CN 滤清器扳手

60-120 mm 280 mm ADJUSTABLE NASTAWNY



YATO	Ø [mm]	L [mm]	
YT-08231	60-120	280	6/36

EN Oil filter wrench
 PL Klucz do filtra oleju
 DE Ölfilterschlüssel
 RU Съёмник масляного фильтра
 CZ Klíč na olejový filtr
 HU Olajszűrő leszedő
 RO Cheie pt. filtru de ulei
 FR Clé pour filtre à huile
 IT Chiave per filtro olio
 ES Llave para filtro de aceite
 CN 滤清器扳手

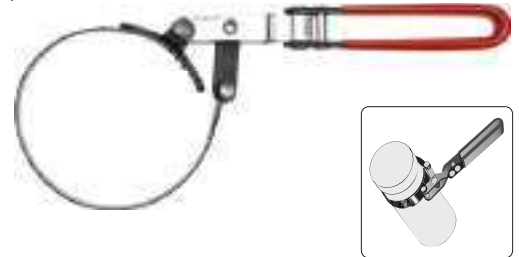

YATO	Ø [mm]	
YT-0820	60-73	12/48
YT-0821	73-85	12/48
YT-0822	85-95	12/48
YT-0823	95-111	12/48

EN Belt oil wrench
 PL Klucz taśmowy do filtrów oleju
 DE Ölfilterschlüssel mit Riemen
 RU Ключ тросовый для масляных фильтров
 CZ Klíč na olejové filtry
 HU Olajszűrő leszedő

RO Cheie filtru cu banda
 FR Clé au filtre d'huile
 IT Chiave a nastro per filtro olio
 ES Llave de cinta para filtros de aceite
 CN 皮带钳扳手



YATO	Ø [mm]	
YT-0824	80-160	6/60
YT-0825	100-200	5/20

EN Oil filter wrench
 PL Klucz do filtra oleju
 DE Ölfilterschlüssel
 RU Съёмник масляного фильтра
 CZ Klíč na olejový filtr
 HU Olajszűrő leszedő
 RO Cheie pt. filtru de ulei
 FR Clé pour filtre à huile
 IT Chiave per filtro olio
 ES Llave para filtro de aceite
 CN 滤清器扳手

2.5"-4" 63-120 mm 3/8" 9.5mm 1/2" 12.7mm HRC 40-50 CrV



YATO	
YT-0826	12/36

EN Fuel filter socket
 PL Nasadka do filtra paliwa
 DE Aufsatz für Kraftstofffilter
 RU Крышка для топливного фильтра
 CZ Násada do palivového filtru
 HU Üzemanyagszűrő fedél kulcs
 RO Cheie pt. filtru combustibil
 FR Douille pour filtre à carburant
 IT Attacco per filtro del carburante
 ES Vaso para filtro de combustible
 CN 燃油过滤器套筒



1/2"
12.7mm 27 mm CrV FOR FUEL FILTER DO FILTRU PALIWA

YATO	Ø	
YT-12000	1/2" (12.5 mm)	20/40

EN Haldex filter service tool
 PL Klucz specjalny do filtra haldex
 DE Spezialschlüssel für Haldex-Filter
 RU Специальный ключ для фильтра haldex
 CZ Speciální klíč do filtru haldex
 HU Speciális kulcs haldex szűrőhöz

RO Instrument service filtru haldex
 FR Clé pour filtre haldex
 IT Chiave filtro olio per frizione haldex
 ES Llave especial para el filtro haldex
 CN 差速器滤芯板

46 mm 390 mm CrMo VAG HALDEX



YATO	L [mm]	
YT-05971	390	10/20

- EN Cap type oil filter wrench set
- PL Zestaw kluczy nasadowych do filtra oleju
- DE Steckschlüsselsatz für Ölfilter
- RU Набор торцевых ключей к масляному фильтру
- CZ Sada miskovitých klíčů na olejové filtry
- HU Dugókulcs készlet olajsűrőhöz
- RO Set de chei tubulare pt. filtru de ulei
- FR Set d'embouts aux filtres d'huile
- IT Set di chiavi filtro olio
- ES Juego de llaves de tubo para el filtro de aceite
- CN 碗型滤清器扳手组套

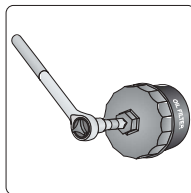

number numer	size rozmiar	layers warstwy	grooves bruzdy	faces powierzchnie	car models modele samochodu
66/6	SW66	1	6		Fiat Punto 1.2, Renault Clio 1.2, Rapid, Twingo
76/8	SW76	1	8		Fiat, Lancia
76/12	SW76	1		12	Fiat, Mercedes, Renault
86/16	SW86	1		16	Volvo
86/18	SW86	1		18	VW Golf, Audi A6 TDI, Peugeot, Citroen
92/10	SW92	1		10	Fiat
93/45	SW93	1	45		VW, Audi TDI
96/18	SW96	1	18		Audi A4, A6 TDI, VQ Passat TDI, Renault Laguna
106/15	SW106	1		15	Fiat Ducato
108/15	SW108	1		15	Volvo
108/18	SW108	1	18		Renault Espace, Laguna, Safrane, Traffic

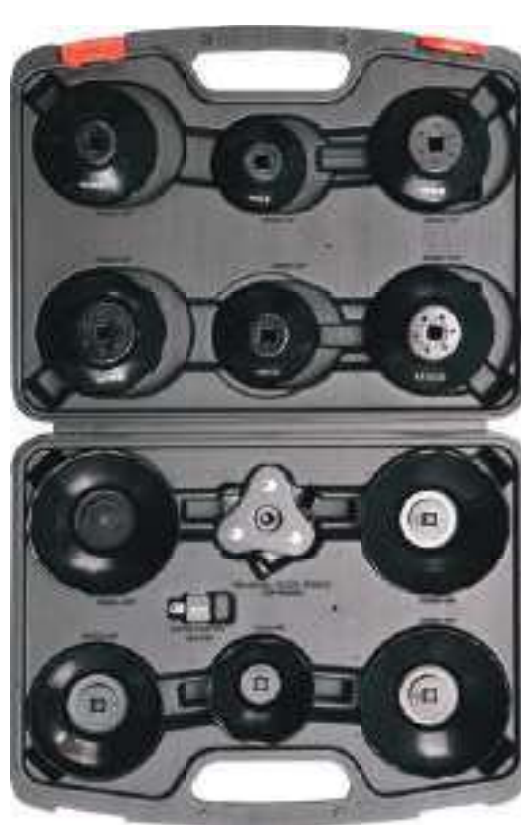

13
PCS

65-120
mm

3/8"
9.5 mm

1/2"
12.7 mm



YATO 
YT-0594

5

- EN Cap type oil filter wrench set
- PL Zestaw kluczy nasadowych do filtra oleju
- DE Steckschlüsselsatz für Ölfilter
- RU Набор торцевых ключей к масляному фильтру
- CZ Sada miskovitých klíčů na olejové filtry
- HU Dugókulcs készlet olajsűrőhöz
- RO Set de chei tubulare pt. filtru de ulei
- FR Set d'embouts aux filtres d'huile
- IT Set di chiavi filtro olio
- ES Juego de llaves de tubo para el filtro de aceite
- CN 碗型滤清器扳手组套

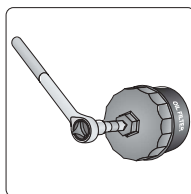

number numer	size rozmiar	layers warstwy	grooves bruzdy	faces powierzchnie	car models modele samochodu
66/6	SW66	1	6		Fiat Punto 1.2, Renault Clio 1.2, Rapid, Twingo
65/14	SW65	1		14	Daihatsu, Toyota, Nissan, Fiat
65/67	SW65-67	1		14	Daihatsu, Toyota
68/14	SW68	1		14	Mazda, Ford, Subaru
73/14	SW73	1		14	Toyota, Lexus
74/15	SW74	1		15	Audi, Rover, Chrysler
74/76	SW74-76	2		15	Ford, Opel, VW, Audi, Mercedes
75/77	SW75-77	2		15	VW, Audi, Isuzu, Mercedes
76/12	SW76	1		12	Fiat, Mercedes, Renault
76/14	SW76	1		14	VW, Porsche, Mercedes, BMW, Audi, Opel
76/30	SW76	1	30		Ford
76/8	SW76	1	8		Fiat, Lancia
78/15	SW78	1		15	Nissan, Ford, Toyota
80/15	SW80	1		15	Nissan, Honda, Opel, Mazda
80/82	SW80-82	2		15	Subaru, Toyota, Honda, Nissan
86/16	SW86	1		16	Volvo
86/18	SW86	1		18	VW Golf, Audi A6 TDI, Peugeot, Citroen
90/15	SW90	1		15	Honda, Mitsubishi, Isuzu
92/10	SW92	1		10	Fiat
93/15	SW93	1		15	Mazda, Volvo, Mitsubishi, Nissan, Honda
93/36	SW93	1	36		Ford
93/45	SW93	1	45		VW, Audi TDI
95/15	SW95	1	15		Toyota, Alfa Romeo, Ford
96/18	SW96	1	18		Audi A4, A6 TDI, VQ Passat TDI, Renault Laguna
100/15	SW100	1		15	Isuzu, Mitsubishi
106/15	SW106	1		15	Fiat Ducato
108/15	SW108	1		15	Volvo
108/18	SW108	1	18		Renault Espace, Laguna, Safrane, Traffic



30
PCS

3/8"
9.5 mm



YATO 
YT-0596

3

EN Square oil drain plug wrench
 PL Klucz do korków spustowych oleju
 DE Schlüssel für Ölablassschraube
 RU Ключ для масляной пробки
 CZ Klíč do spouštěcích zátek oleje
 HU Olajleeresztő csavar kulcs

RO Cheie pt. bușon ulei
 FR Clé pour bouchons de vidange d'huile
 IT Chiave per tappo di scarico olio
 ES Llave para tapones de descarga de aceite
 CN 方形放油塞扳手



Peugeot, Renault, Volvo

YATO	
YT-05995	6/36

EN Plastic oil plug driver set
 PL Komplet kluczy do plastikowych korków oleju
 DE Schlüsselsatz für Plastikölstopfen
 RU Набор ключей для пластиковых масляных пробок
 CZ Sada klíčů na plastové olejové zátky
 HU Kulcskészlet műanyag olajleeresztő dugókhoz
 RO Set chei pt. bușon ulei de plastic
 FR Clés universelles pour bouchons de vidange d'huile en matière plastique
 IT Set di chiavi per tappi olio in plastica
 ES Juego de llaves para tapones de plástico para aceite
 CN 塑料油塞扳手组



BMW, Ford, PSA, VAG

YATO	
YT-05980	20/40

EN Oil drain plug key set
 PL Komplet kluczy do korków oleju
 DE Ölablassschrauben-Schlüssel-Satz
 RU Комплект ключей для сливной пробки
 CZ Klíče nástrčné na zátky olejových van motorů
 HU Olajleeresztő kulcs készlet

RO Set chei pt. bușon ulei
 FR Ensemble de clés de bouchon de vidange d'huile
 IT Set di chiavi a bussola
 ES Juego de llaves para tapones de aceite
 CN 油底壳螺丝组套



8, 3/8", 10, 12, 1/2", 14 mm;
 3/8" (9.5 mm), 1/2" (12.7 mm)

YATO	
YT-05997	10/40

EN Oil pan drain plug removal set
 PL Zestaw do obsługi korków spustowych oleju
 DE Ölablassschrauben-Schlüssel-Satz
 RU Комплект для открывания масляных пробок
 CZ Sada pro demontáž vypouštěcí zátky olejové vany
 HU Olajleeresztő dugó kezelő készlet
 RO Kit demontare a dopului de scurgere a barii de ulei
 FR Kit d'entretien de bouchons de vidange d'huile
 IT Kit per la rimozione di tappi per olio
 ES Juego para extraer tapones de drenaje de aceite
 CN 塑料油底壳拆装工具



VAG

YATO	
YT-05994	12/72

EN Oil drain plug key set
 PL Komplet kluczy do korków oleju
 DE Ölablassschrauben-Schlüssel-Satz
 RU Комплект ключей для сливной пробки
 CZ Klíče nástrčné na zátky olejových van motorů
 HU Olajleeresztő kulcs készlet

RO Set chei pt. bușon ulei
 FR Ensemble de clés de bouchon de vidange d'huile
 IT Set di chiavi a bussola
 ES Juego de llaves para tapones de aceite
 CN 排油塞旋具组套



3/8" (9.5 mm): 7, 8, 10, 11, 12, 13, 14 mm;
 5/16" (7.9 mm), 3/8" (9.5 mm);
 3/8" (9.5 mm): 8, 9, 10, 12, 14, 17 mm;
 3/8" (9.5 mm): 10 mm;
 3/8" (9.5 mm): M16;
 3/8" (9.5 mm): 10 mm

YATO	
YT-05991	5/10

EN Oil drain plug set
PL Komplet kluczy do korków oleju
DE Ölablasschrauben-Schlüssel-Satz
RU Комплект ключей для сливной пробки
CZ Klíče nástrčné na zátky olejových van motorů
HU Olajleeresztő kulcs készlet

RO Set chei pt. bușon ulei
FR Ensemble de clés de bouchon de vidange d'huile
IT Set di chiavi a bussola
ES Juego de llaves para tapones de aceite
CN 排油塞旋具组套

18
PCS

3/8"
9.5 mm

CrV



- □ 3/8" (9.5 mm): 7, 8, 10, 11, 12, 13, 14 mm;
- □ 5/16" (7.9 mm), 3/8" (9.5 mm);
- □ 3/8" (9.5 mm): 8, 9, 10, 12, 14, 17 mm;
- △ □ 3/8" (9.5 mm): 10 mm;
- 3/8" (9.5 mm): 10 mm; □ 3/8" (9.5 mm): 160 mm

YATO	○	□
YT-0599	3/8" (9.5 mm)	10

EN Grease gun
PL Smarownica ręczna
DE Handhebel-Fettpresse
RU Шприц для смазки ручной
CZ Maznice páková
HU Karos zsírzó



YATO	□	□
YT-0700	20	

RO Pistol de grasat
FR Pompe à graisse manuelle
IT Ingrassatore manuale
ES Pistola de engrase manual
CN 手动黄油枪

70
MPa
(max.)

31
MPa

500
cm³

AI



YATO	□	□
YT-0705	20	

EN Grease gun
PL Smarownica ręczna
DE Handhebel-Fettpresse
RU Шприц для смазки ручной
CZ Maznice páková
HU Karos zsírzó
RO Pistol de grasat
FR Pompe à graisse manuelle
IT Ingrassatore manuale
ES Pistola de engrase manual
CN 手动黄油枪



YATO	□	□
YT-07042	6/12	

EN Oil drain plug key set
PL Komplet kluczy do korków oleju
DE Ölablasschrauben-Schlüssel-Satz
RU Комплект ключей для сливной пробки
CZ Klíče nástrčné na zátky olejových van motorů
HU Olajleeresztő kulcs készlet

RO Set chei pt. bușon ulei
FR Ensemble de clés de bouchon de vidange d'huile
IT Set di chiavi a bussola
ES Juego de llaves para tapones de aceite
CN 排油塞组套

12
PCS

3/8"
9.5 mm

CrV



- □ 3/8" (9.5 mm): 8, 11, 13 mm;
- □ 3/8" (9.5 mm): 8, 9, 10, 12, 14, 17 mm

YATO	○	□
YT-0600	3/8" (9.5 mm)	10

EN Grease gun
PL Smarownica ręczna
DE Handhebel-Fettpresse
RU Шприц для смазки ручной
CZ Maznice páková
HU Karos zsírzó
RO Pistol de grasat
FR Pompe à graisse manuelle
IT Ingrassatore manuale
ES Pistola de engrase manual
CN 手动黄油枪



70
MPa
(max.)

31
MPa

120
cm³

AI



YATO	□	□
YT-0701	30	

EN Grease gun
PL Smarownica ręczna
DE Handhebel-Fettpresse
RU Шприц для смазки ручной
CZ Maznice páková
HU Karos zsírzó



70
MPa
(max.)

31
MPa

600
cm³

AI



YATO	□	□
YT-07044	6	

EN Grease gun
PL Smarownica ręczna
DE Handhebel-Fettpresse
RU Шприц для смазки ручной
CZ Maznice páková
HU Karos zsírzó
RO Pistol de grasat
FR Pompe à graisse manuelle
IT Ingrassatore manuale
ES Pistola de engrase manual
CN 手动黄油枪



27-41
MPa

800
cm³

AI



YATO	□	□
YT-07043	4/8	

EN Two-way operation grease gun
 PL Smarownica ręczna, wzmocniona
 DE Handhebel-Fettpresse
 RU Шприц для масляной смазки
 CZ Páková maznice
 HU Karos zsíröz

RO Masina de gresat cu furtun rigid
 FR Pistolet de graissage manuel
 IT Lubrificatore manuale
 ES Pistola de engrase
 CN 重型黄油枪

70 MPa (max.)
 42 MPa
 500 cm³
 AI



YATO YT-0704 12

EN Two-way operation grease gun
 PL Smarownica ręczna, wzmocniona
 DE Handhebel-Fettpresse
 RU Шприц для масляной смазки
 CZ Páková maznice
 HU Karos zsíröz

RO Masina de gresat cu furtun rigid
 FR Pistolet de graissage manuel
 IT Lubrificatore manuale
 ES Pistola de engrase
 CN 重型黄油枪

70 MPa (max.)
 42 MPa
 500 cm³
 AI



YATO YT-07041 10

EN Grease gun
 PL Smarownica ręczna
 DE Handhebel-Fettpresse
 RU Шприц для смазки ручной
 CZ Maznice páková
 HU Karos zsíröz
 RO Pistol de gresat
 FR Pompe à graisse manuelle
 IT Ingrassatore manuale
 ES Pistola de engrase manual
 CN 手用黄油枪



55 MPa (max.)
 24.8 MPa
 400 cm³
 AI



YATO YT-07045 6

EN Grease gun
 PL Smarownica ręczna
 DE Handhebel-Fettpresse
 RU Шприц для смазки ручной
 CZ Maznice páková
 HU Karos zsíröz

RO Pistol de gresat
 FR Pompe à graisse manuelle
 IT Ingrassatore manuale
 ES Pistola de engrase manual
 CN 手用黄油枪

69 MPa (max.)
 27.6 MPa
 400 cm³
 AI



YATO YT-07046 8

EN Extraction & fill pump
 PL Odśysarka ręczna do płynów eksploatacyjnych
 DE Manuelle Absaugvorrichtung für Betriebsflüssigkeiten
 RU Ручной отсос для рабочих жидкостей
 CZ Ruční odsávací zařízení provozních kapalin
 HU Kézi üzemi folyadék elszívó

RO Pompa pt. extras si umplut
 FR Appareil portable de vidange par aspiration
 IT Aspiratore manuale per liquidi
 ES Dispositivo de succión manual
 CN 抽油泵

200 ml
 FOR OPERATIONAL LIQUIDS DO NOT MIX EXPLODABLE MIXTURES



YATO YT-07083 24

EN Extraction & fill pump
 PL Odśysarka ręczna do płynów eksploatacyjnych
 DE Manuelle Absaugvorrichtung für Betriebsflüssigkeiten
 RU Ручной отсос для рабочих жидкостей
 CZ Ruční odsávací zařízení provozních kapalin
 HU Kézi üzemi folyadék elszívó

RO Pompa pt. extras si umplut
 FR Appareil portable de vidange par aspiration
 IT Aspiratore manuale per liquidi
 ES Dispositivo de succión manual
 CN 抽加油壶

500 ml
 FOR OPERATIONAL LIQUIDS DO NOT MIX EXPLODABLE MIXTURES



YATO YT-07084 20

EN Oil transfer pump
 PL Pompa transferowa do oleju
 DE Öl-Umfüllpumpe
 RU Шприц для перекачки масел
 CZ Ruční olejová pumpa
 HU Olajpumpa

RO Pompa de ulei de mana
 FR Pompe pour huile
 IT Lubrificatore manuale per travaso olio
 ES Bomba manual de trasvase dual
 CN 输油泵

70 MPa (max.)
 31 MPa
 500 cm³



YATO YT-0707 20

EN Oil drainer
 PL Odśysarka ręczna do oleju
 DE Öl-Absaugpumpe
 RU Ручной шприц для откочки масла
 CZ Ruční odsávací leje
 HU Olajszívattyú

RO Pompa de ulei
 FR Seringue à huile
 IT Lubrificatore manuale per aspirazione olio
 ES Bomba manual de trasvase
 CN 输油泵

70 MPa (max.)
 31 MPa
 500 cm³



YATO YT-0708 20

- EN Grease gun adaptors set
PL Zestaw końcówek do smarownic
DE Mundstücksatz für Fettpressen
RU Набор наконечников для смазочного шприца
CZ Sada koncovek pro maznice
HU Olajózó fejkészlet
RO Set adaptoare pt. gresoare
FR Jeu d'accessoires pour pompes à graisse
IT Kit di nipples per ingrassatori
ES Juego de puntas para engrasadores
CN 黄油嘴配件套装



- EN Grease coupler
PL Glowica do smarownicy
DE Fettpressenkopf
RU Головка для пресс-масленки
CZ Hlavice do maznice
HU Olajózó fej
RO Cupla pt. pistol de gresat
FR Tête de graisseur
IT Testa per lubrificatore
ES Cabezal para engrasador
CN 高压油嘴头

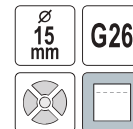

YATO		
YT-07110		10

YATO	Ø [mm]	
YT-07102	15	18/72

- EN Multi-use transfer pump
PL Pompa transferowa do płynów
DE Übertragungspumpe für Flüssigkeiten
RU Перекачивающий насос для жидкостей
CZ Přecerpávací čerpadlo na kapaliny
HU Aktivő szivattyú folyadékokhoz

- RO Pompa de transfer multifunctionala
FR Pompe de transfert de liquides
IT Pompa di trasferimento per liquidi
ES Bomba de transferencia de líquidos
CN 打气筒



YATO	[ml]	
YT-07071	170	6/24

- EN Manual hand pump
PL Odśysarka ręczna do płynów eksploatacyjnych
DE Handabsauger für Betriebsflüssigkeiten
RU Ручной инструмент для всасывания рабочих жидкостей
CZ Ruční odsávací zařízení provozních kapalin
HU Kézi szivattyú üzemi folyadékokhoz
RO Pompa manuala
FR Pompe d'aspiration manuelle de fluides
IT Aspiratore manuale per liquidi
ES Bomba manual para fluidos de trabajo
CN 抽油泵

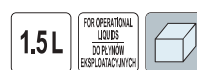

Opel, PSA

YATO		
YT-07082		20

- EN Grease pump
PL Smarownica ręczna
DE Manuelle fettumpfen
RU Шприц для смазки

- CZ Maznice ruční
HU Kézi zsírózó pumpa
RO Grăsimă manual pompa
FR Pistolet de graissage manuel

- IT Pompe manuali per grasso
ES Grasa manual de la bomba
CN 黄油泵



13.8 MPa (max.)
4 kg



13.8 MPa (max.)
8 kg



20.5 MPa (max.)
16 kg

YATO	Grease tank capacity / Pojemność zbiornika smaru [kg]	
YT-07061	4	1

YATO	Grease tank capacity / Pojemność zbiornika smaru [kg]	
YT-07063	8	1

YATO	Grease tank capacity / Pojemność zbiornika smaru [kg]	
YT-07065	16	1

- EN Flexible tube for grease gun
PL Wężyk do towotnicy
DE Schlauch für Fettpresse
RU Шприц для перекачки масел
CZ Hadička na maznice na šmír
HU Tömrlő a zsírózóhoz

- RO Furtun flexibil pt. pistol de gresat
FR Flexible pour graisseur
IT Tubo flessibile per ingrassatore
ES Manguera para engrasador
CN 手动黄油枪软管



YATO	L [mm]	
YT-0709	300	12/144
YT-0710	500	12/144

- EN Flexible hose for grease gun
PL Wężyk do towotnicy
DE Fettpressenschlauch
RU Шланг для тавотницы
CZ Hadička do vazelíny
HU Cső zsírózóhoz

- RO Tub flexibil pt. pistol de gresat
FR Flexible pour graisseur
IT Tubo flessibile per ingrassatore
ES Manguera para engrasador
CN 高压尼龙软管

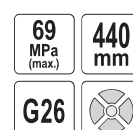

YATO	L [mm]	
YT-07101	440	9/36

EN Oiler with a flexible applicator
 PL Oliwiarka z elastycznym aplikatorem
 DE Ölkanne mit elastischem Applikator
 RU Масленка с гибким аппликатором
 CZ Olejníčka s ohebným aplikátorem
 HU Hajlékony csővű olajzó
 RO Gresor cu aplicator flexibil
 FR Burette à huile
 IT Lubrificante con canna flessibile
 ES Aceitera con aplicador flexible
 CN 油壶



200 ml

IMPACT RESISTANT
ODPORNY NA UDERZENIA



10/120



300 ml

IMPACT RESISTANT
ODPORNY NA UDERZENIA



10/120



500 ml

IMPACT RESISTANT
ODPORNY NA UDERZENIA



10/80



YATO	V [cm ³]	
YT-0690	220	10/120
YT-0691	270	10/120

YATO	V [ml]	
YT-06912	200	10/120

YATO	V [ml]	
YT-06913	300	10/120

YATO	V [ml]	
YT-06914	500	10/80

EN Precision oiler
 PL Oliwiarka precyzyjna
 DE Präzisionsöler
 RU Прецизионная масленка
 CZ Přesná olejníčka
 HU Precíz olajzó
 RO Gresor de precizie
 FR Graisseur de précision
 IT Oliatore di precisione
 ES Aceitera de precisión
 CN 润滑油笔



15 ml

150 mm

AI



YATO	V [ml]	
YT-06977	15	12/120

EN Engine oil filler set
 PL Lejek do wlewania oleju z adapterami
 DE Ölfüller-Set
 RU Воронка для моторного масла с адаптерами
 CZ Sada pro plnění motorového oleje
 HU Olajfelöltő adapter
 RO Palnie cu adaptor pt. capacul de ulei
 FR Adaptateur de remplissage d'huile aide avec entonnoir
 IT Imbuto per versare olio con adattatori
 ES Automotivo embudo de llenado de aceite
 CN 加油漏斗套装



15 PCS

2L

FOR TIGHT SPACES
DO CIASNÝCH PRZESTRZENI



YATO	
YT-06919	4

EN Oil pump
 PL Pompa tłokowa do oleju
 DE Öl-Umfüllpumpe
 RU Шприц ручной заливной
 CZ Ruční olejová pumpra
 HU Olajpumpa
 RO Pompa de ulei de mana
 FR Pompe pour huile
 IT Pompa manuale travaso fusti olio
 ES Bomba manual para aceite
 CN 吸油泵



16-18 l/min

45-90 cm

max 55 min²

0.31 CYCLE CYCLE

AI

FOR OIL DO OLEJU



YATO	
YT-0712	10

EN Aluminium rotary oil pump
 PL Aluminiowa pompa do oleju
 DE Aluminium-Kurbelpumpe
 RU Алюминиевый ручной боковой насос
 CZ Hliník rotační čerpadlo
 HU Alumínium rotációs szivattyú
 RO Aluminiu pompă rotativă
 FR Pompe manuelle pour huile
 IT Pompa a mano per olio
 ES Aluminio bomba rotaria
 CN 手摇油泵



21 l/min

500 cm

300 cm

x3 PIPE RURA

AI

FOR OIL DO OLEJU



YATO	
YT-07115	10

EN High value rotary barrel pump
 PL Wysokowydajna pompa rotacyjna do paliwa
 DE Kurbelpumpe für Benzinfässer
 RU Насос топливный ротационный
 CZ Čerpadlo palivové rotační
 HU Kézi pumpra hordóhoz (forgatható)
 RO Pompa rotativa pt. combustibil
 FR Pompe rotative à combustible
 IT Pompa rotativa travaso gasolio
 ES Bomba de combustible rotatoria
 CN 手摇泵



100 l/min

100 cm

1.01 CYCLE CYCLE

180µm BRASS FILTER MOSENY FILTRE

2.4m ANTISTATIC ROSE NA ANTISTATIZEN

AI



FOR FUELS AND OIL DO PALIW I OLEJU



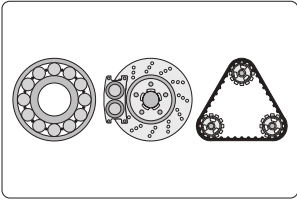

YATO	
YT-0715	4

EN Two arms jaw puller RU Съёмник для подшипников RO Extractor rulmenti ES Extractor
PL Ściągacz dwuramienny CZ Stahovák FR Extracteur CN 两爪拉马
DE Abzieher-2-armig HU Csapágyelhűző IT Estrattore









 10 mm
 4" 100 mm
max Ø 60 mm
max 1.2t



 10 mm
 3" 76 mm
max Ø 75 mm
max 1.1t



YATO 	 [mm]	[mm]	max. Ø [mm]	max. [t]	
YAT-2514	10	100	60	1.2	6/60



YATO 	 [mm]	[mm]	max. Ø [mm]	max. [t]	
YAT-2515	10	76	75	1.1	6/60

 12 mm
 4" 100 mm
max Ø 100 mm
max 1.4t









 17 mm
 6" 150 mm
max Ø 120 mm
max 6t





 22 mm
 8" 200 mm
max Ø 180 mm
max 9t





YATO 	 [mm]	[mm]	max. Ø [mm]	max. [t]	
YAT-2516	12	100	100	1.4	12/48

YATO 	 [mm]	[mm]	max. Ø [mm]	max. [t]	
YAT-2517	17	150	120	6	10/20

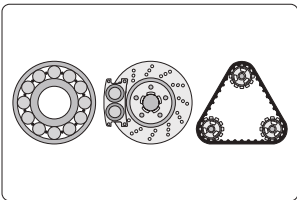

YATO 	 [mm]	[mm]	max. Ø [mm]	max. [t]	
YAT-2518	22	200	180	9	6

EN Three arms jaw puller RU Съёмник для подшипников RO Extractor rulmenti cu trei brate ES Extractor detres patas
PL Ściągacz trójramienny CZ Stahovák třiramenný FR Extracteur CN 三爪拉马
DE Abzieher-3-armig HU Csapágyelhűző IT Estrattore







 10 mm
 3" 76 mm
max Ø 80 mm
max 1.5t



 12 mm
 4" 100 mm
max Ø 100 mm
max 2.5t



YATO 	 [mm]	[mm]	max. Ø [mm]	max. [t]	
YAT-2519	10	76	80	1.5	6/60



YATO 	 [mm]	[mm]	max. Ø [mm]	max. [t]	
YAT-2520	12	100	100	2.5	6/36

 17 mm
 6" 150 mm
max Ø 130 mm
max 5t









 22 mm
 8" 200 mm
max Ø 180 mm
max 9t





 22 mm
 12" 300 mm
max Ø 180 mm
max 11t



YATO 	 [mm]	[mm]	max. Ø [mm]	max. [t]	
YAT-2521	17	150	130	5	12

YATO 	 [mm]	[mm]	max. Ø [mm]	max. [t]	
YAT-2522	22	200	180	9	4

YATO 	 [mm]	[mm]	max. Ø [mm]	max. [t]	
YAT-2523	22	300	180	11	2

EN Three arms jaw puller
 PL Ściągacz trójramienny
 DE Abzieher-3-armig
 RU Съёмник для подшипников

CZ Stahovák tříramenný
 HU Csapágyelhúzó
 RO Extractor rulmenti cu trei brate
 FR Extracteur

IT Estrattore
 ES Extractor detres patas
 CN 三爪拉马

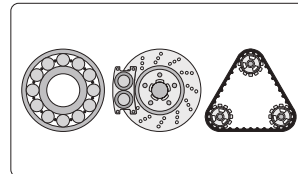

14 mm
 3" 76 mm
 50-150 mm



15 mm
 4" 100 mm
 60-200 mm



19 mm
 6" 150 mm
 80-300 mm

YATO	14 [mm]	76 [mm]	50-150 [mm]	20
YT-2511				

YATO	15 [mm]	100 [mm]	60-200 [mm]	20
YT-2512				

YATO	19 [mm]	150 [mm]	80-300 [mm]	10
YT-2513				

EN Universal puller set
 PL Ściągacz do łożysk w miejscach trudnodostępnych
 DE Abziehvorrichtung für Lager
 RU Съёмник подшипников в труднодоступных местах
 CZ Sada na stahování ložisek na obtížně dostupných místechy
 HU Csapágyelhúzó
 RO Trăgător pt. rulmenți în locuri greu accesibile
 FR Extracteur aux roulements
 IT Set di estrattori universali
 ES Extractor de rodamientos en lugares de difícil acceso
 CN 多功能拉拔器

12 PCS
 DROP FORGED KUTE
 FOR TIGHT SPACES DO CÍSNÝCH PŘEZSTRŽENÍ

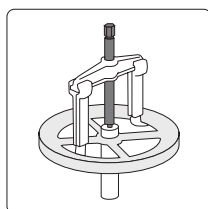
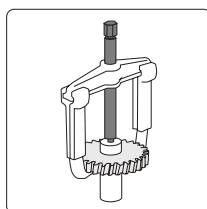
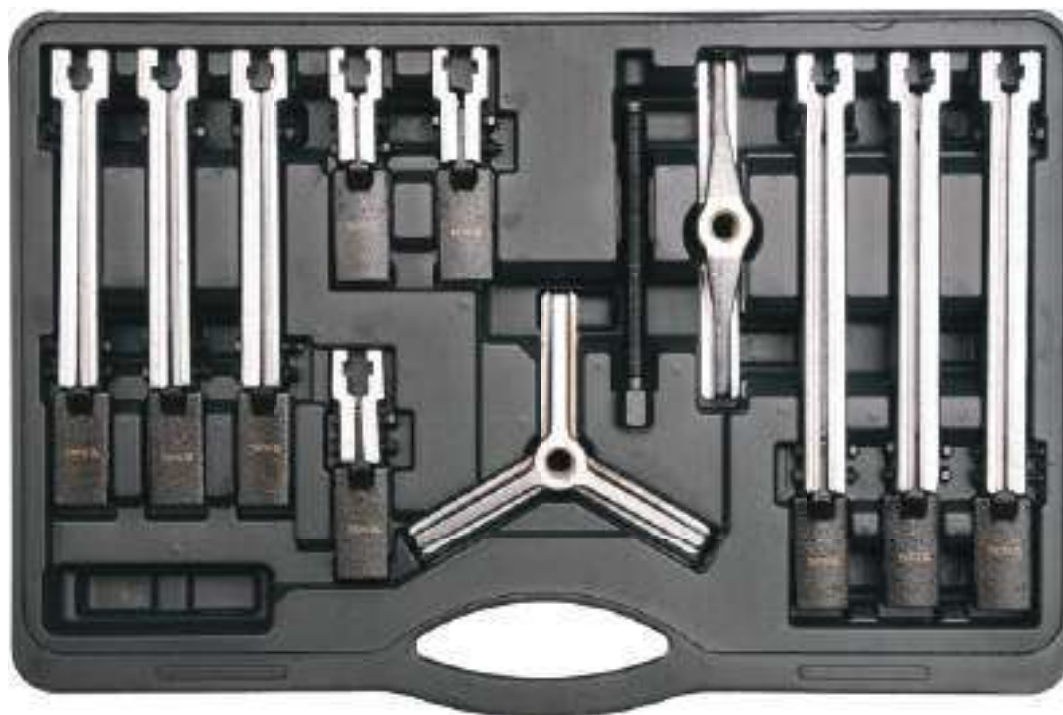

3 x 250 mm;
 3 x 200 mm;
 3 x 100 mm;
 160 mm;

YATO	2
YT-25105	

EN Pilot bearing puller
PL Ściągacz do łożysk
DE Abzieher für Innenlager
RU Съёмник внутренних подшипников
CZ Stahovák na ložiska vnitřní
HU Csapágylehűző
RO Clește interior pt. extras rulmenți
FR Extracteur intérieur aux roulements
IT Estrattore cuscinetti
ES Extractor de cojinetes inter
CN 轴承拉马

13-38 mm CrV 6150



YATO Ø [mm]
YT-2510 13-38 20

EN Separator and hydraulic cylinder turnbuckle
PL Separator i ściągacz z siłownikiem hydraulicznym
DE Separator und Abziehvorrichtung mit Hydraulikservomotor
RU Сепаратор и съёмник с сервомотором
CZ Oddělovač a stahovák s hydraulickým válcem
HU Csapágylehűző és körmös csapágylehűző hidraulikus kézpumpával
RO Separator și ancoră cu servomotor hidraulic
FR Séparateur avec actionneur hydraulique
IT Separatore frizione cilindro idraulico
ES Separador y tensor de tornillo con cilindro hidráulico
CN 液压分离器组合

75-105mm 80-80mm

50 kN HYDRAULIC CYLINDER SIŁOWNIK HYDRAULICZNY

HRC 38-45 DROP FORGED KUTE

CrV

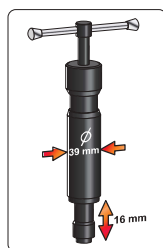

YATO Force pressure / Siła nacisku [kN]
YT-0609 50 2

EN Gear puller set
PL Ściągacz dwuramienny i separator
DE Lagerabzieher, Trennmesser
RU Съёмник универсальный с сепаратором
CZ Stahovák dvouramenný
HU Csapágylehűző készlet
RO Set angrenaj pt. extras
FR Extracteur 2 bras + séparateur
IT Estrattore a due bracci a separatore
ES Kit de extractor
CN 齿轮拉拔器

35-150mm max 43mm

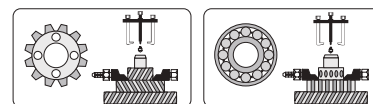
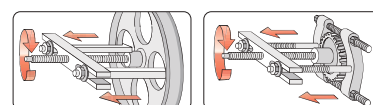
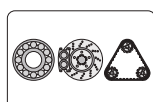

YATO
YT-0641 4

EN Universal wheel hub puller
PL Ściągacz uniwersalny do tarcz i bębnow
DE Scheiben- und Trommelbremsen Abzieher
RU Универсальный съёмник ступицы и полуоси
CZ Stahovák na brzdové bubny
HU Univerzális féktárcsa és fékdob lehűző
RO Trusa universală pt. transmisie cardanica
FR Extracteur universel pour les disques et les tambours
IT Estrattore a vite universale
ES Extractor universal de discos y tambores
CN 万用轮毂拉马

90-140mm 130-180mm CrV

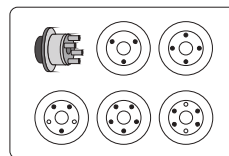

YATO
YT-0602 6

EN Twin leg puller with jaw hook
PL Ściągacz uniwersalny dwuramienny
DE Doppel Abzieher mit Haken
RU Съёмник универсальный
CZ Stahovák dvouramenný univerzální
HU Csapágylehűző készlet
RO Carlig cu falci pt. extras cu picior dublu
FR Extracteur universel à deux bras
IT Estrattore universale a due bracci
ES Extractor de cuatro patas
CN 单边两爪拉马



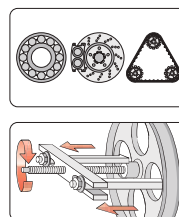

40-220mm





YATO
YT-0640 10

- EN Gear puller set
- PL Ściągacz dwuramienny i separator
- DE Lagerabzieher, Trennmesser
- RU Съёмник универсальный с сепаратором
- CZ Stahovák dvouarmenný
- HU Csapágylehúzó készlet
- RO Set angrenaj pt. extras
- FR Extracteur 2 bras + séparateur
- IT Estrattore a due bracci a separatore
- ES Kit de extractor
- CN 齿轮拉拔器

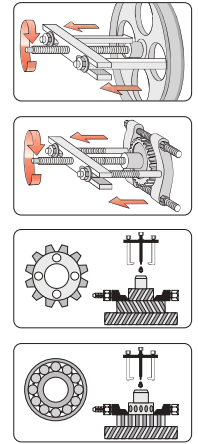

14 PCS	 35-130 mm
 max 60 mm	 max 75 mm
	



YATO 	
YT-06412	2

- EN Slide hammer and bearing puller set
- PL Ściągacz bezwładnościowy do łożysk
- DE Träge Abziehvorrichtung für Lager
- RU Набор съёмников с обратным молотком
- CZ Rázový stahovák s kluzným kladivem na ložiska
- HU Csúszósúlyos csapágylehúzó készlet
- RO Set ciocan culisant extractor de rulmenti
- FR Extracteur de roulements à inertie
- IT Set estrattori interni / esterni
- ES Extractor de inercia para cojinetes
- CN 滑锤轴承拉拔器组套

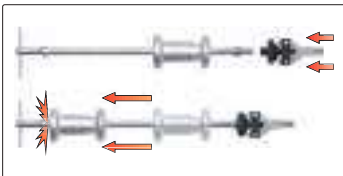

5 PCS	
-----------------	--

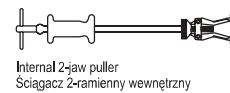
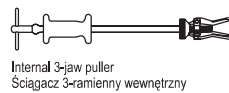
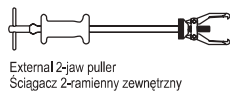
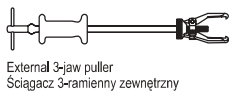

YATO 	
YT-2540	2

- EN Bearing extractor set
- PL Ściągacz bezwładnościowy do łożysk
- DE Trägheitsabziehvorrichtung für Lager
- RU Инерционный съёмник подшипников
- CZ Stahovák kluzného ložiska
- HU Csúszó kalapácsos csapágylehúzó
- RO Set extractor rulment
- FR Extracteur de roulements
- IT Kit estrattori cuscinetti
- ES Extractor de rodamientos por inercia
- CN 内轴承拉马

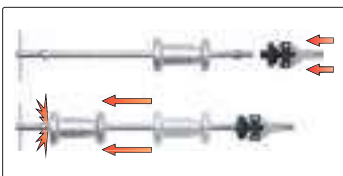

15 PCS	 8-58 mm
INTERNAL PULLER ŚCIAGACZ WEWNĘTRZNY	

YATO 	
YT-25390	2

16
PCS



- EN Slide hammer set
PL Ściągacz bezwładnościowy do piast i łożysk
DE Träge Abziehvorrichtung für Naben und Lager
RU Набор съёмников с обратным моментом
CZ Rázový stahovák s kluzným kládivem na náboje a ložiska
HU Csúsúzólyos kerékagy - és csapágyelhúzó készlet
RO Set ciocan culsant extractor de rulmenti și bucșe
FR Extracteur de roulements et moyeux à inertie
IT Set estrattori per cuscinetti interno
ES Extractor de inercia para cubos y cojinetes
CN 滑锤



Bar Trzonek	Hammer Młot	2x Axle puller 2x Ściągacz osi	Grip wrench adaptor Przejsiówka do klucza	Nut Kołnierz	2-jaw head Głowica 2-zaczeppowa	3-jaw head Głowica 3-zaczeppowa	3x Nut & bolt 3x Nakrętka i śruba	Attachment Gniazdo śruby	Leg Ramię ściągacza	Screw Śruba	Hook Hak
External 3-jaw puller Ściągacz 3-ramienny zewnętrzny	External 2-jaw puller Ściągacz 2-ramienny zewnętrzny	Puller hook Hak	Dent puller Ściągacz blacharski	Internal 3-jaw puller Ściągacz 3-ramienny wewnętrzny	Internal 2-jaw puller Ściągacz 2-ramienny wewnętrzny	Rear axle puller Ściągacz tylnej osi	Grip wrench adapter Adapter klucza				

YATO
YT-25391 2

- EN Front wheel bearing adapter set
PL Ściągacz łożysk piasty przedniej
DE Radlagerabzieher werkzeugsatz vorderachse
RU Набор для снятия переднего подшипника переднеприводных автомобилей
CZ Sada na demontáž ložisek přední nápravy
HU Csapágyelhúzó adapter készlet első futóműhöz
- RO Set schimbat rulment roata fata
FR Extracteur de moyeux
IT Set estrattori per cuscinetti ruota anteriore adattatore universale
ES Extractor de cojinetes para cubos de rueda delanteros
CN 轴承拆装组套

23
PCS
FOR FRONT WHEEL BEARINGS DO ŁOŻYSK PIASTY PRZEDNIEJ

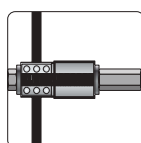

YATO
YT-2541 2

- EN Wheel bearing bushing tool set
PL Zestaw do obsługi łożysk i tulei
DE Radlagerwerkzeug-Satz
RU Набор для обслуживания подшипников и втулок
CZ Sada pro údržbu ložisek a pouzdra
HU Kerékcsapágy persely szerszámkészlet
- RO Set extractoare rulmenti
FR Kit d'outils pour l'installation et démontage du roulement
IT Kit per montaggio / smontaggio dei cuscinetti e manicotti
ES Juego de herramientas de cojinete de rueda
CN 轴承安装工具

26
PCS
FOR BEARINGS AND BUSHINGS DO ŁOŻYSK I TULEI



Ø 10, 12, 14, 16 mm (L=450 mm);
 □ Yellow / Żółte: 46 x 36 mm, 58 x 48 mm, 70 x 60 mm, 82 x 72 mm, 44 x 34 mm, 56 x 46 mm, 68 x 58 mm, 80 x 70 mm, 54 x 44 mm, 66 x 56 mm, 78 x 68 mm;
 □ Silver / Srebrne: 52 x 42 mm, 64 x 54 mm, 76 x 66 mm, 50 x 40 mm, 62 x 52 mm, 74 x 64 mm, 48 x 38 mm, 60 x 50 mm, 72 x 62 mm;
 □ (2 PCS)

YATO
YT-25411 1

- EN Wheel bearing bushing tool set
PL Zestaw do obsługi łożysk i tulei
DE Radlagerwerkzeug-Satz
RU Набор для обслуживания подшипников и втулок
CZ Sada pro údržbu ložisek a pouzdra
HU Kerékcsapágy persely szerszámkészlet
RO Set extractoare rulmenti
FR Kit d'outils pour l'installation et démontage du roulement
IT Kit per montaggio / smontaggio dei cuscinetti e manicotti
ES Juego de herramientas de cojinete de rueda
CN 轴承安装工具

31
PCS
38 mm
FOR BEARINGS AND BUSHINGS DO ŁOŻYSK I TULEI

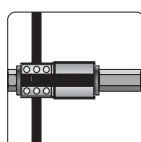

YATO
YT-25412 1

- EN Ball joint separator tool kit
PL Prasa śrubowa do sworzni i tulei
DE Schraubenpresse für Bolzen und Buchsen
RU Винтовой пресс для штифтов и втулок
CZ Šroubovací lis pro čepu a pouzdra
HU Gömbcsukló ki-beszerező készlet
RO Kit extractor articulații cu bilă
FR Clé à douille universelle
IT Estrattore per perni e boccole
ES Prensa de husillo para pernos y casquillos
CN 球头拆卸组套

9
PCS
22 mm
130 mm
FOR PINS AND BUSHINGS DO SWOZNI I TULEI



□ Ø 45/51 x 44 mm, Ø 57/63 x 44 mm; Ø 70/76 x 55 mm

YATO
YT-25413 1

EN Self-tightening pull clamp
 PL Klamra blacharska samozaciskowa
 DE Karosserie-Zugklemme
 RU Зажим для кузовных работ
 CZ Karosářská svěrka samosvorná k tahání
 HU Őnszorító húzóató pófa egyenes
 RO Clemă pt. tablă cu strângere automată
 FR Pince de traction de tirage pour carrosserie
 IT Pinza autoserrante per riparazione carrozzeria
 ES Abrazadera de tiro para reparación de carrocería
 CN 窄型张引夹

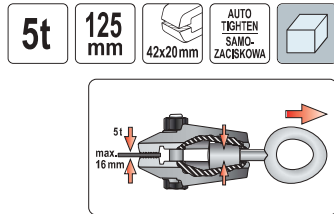

YATO L [mm] 125 12

EN C-type self-tightening pull clamp
 PL Klamra blacharska samozaciskowa typu „C”
 DE Karosserie-Zugklemme Typ „C”
 RU Зажим для кузовных работ типа „C”
 CZ Karosářská svěrka samosvorná k tahání typ „C”
 HU Őnszorító húzóató pófa öblös
 RO Clemă pt. tablă cu strângere automată de tip „C”
 FR Pince de traction de tirage pour carrosserie type C
 IT Pinza autoserrante per riparazione carrozzeria tipo „C”
 ES Abrazadera de tiro para reparación de carrocería tipo „C”
 CN 宽型张引夹

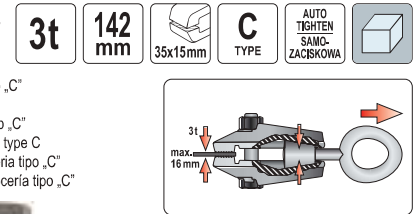

YATO L [mm] 142 10

EN Twist socket set
 PL Zestaw wykrętek do śrub
 DE Schraubendrehersatz
 RU Набор для извлечения обломанных болтов
 CZ Sada vyťahováku stržených šroubů
 HU Törtcsavar kiszedő készlet

RO Set de chei pt. șuruburi
 FR Set d'extracteurs aux vis
 IT Set estrattori per dadi
 ES Juego de destornilladores
 CN 螺栓取出器组套

10 PCS 3/8" 9.5 mm HRC 52-55

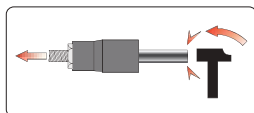

3/8" (9.5 mm): 10, 11, 12, 13, 14, 15, 16, 17, 19 mm;
 Ø 8 mm

YATO YT-0603 20

EN Twist socket set
 PL Zestaw wykrętek do śrub
 DE Schraubendrehersatz
 RU Набор для извлечения обломанных болтов
 CZ Sada vyťahováku stržených šroubů
 HU Törtcsavar kiszedő készlet

RO Set de chei pt. șuruburi
 FR Set d'extracteurs aux vis
 IT Set estrattori per dadi
 ES Juego de destornilladores
 CN 螺栓取出器组套

10 PCS 3/8" 9.5 mm

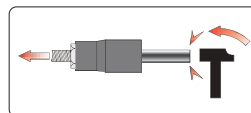

3/8" (9.5 mm): 9, 10, 11, 12, 13, 14, 15, 16, 17, 19 mm

YATO YT-06031 20

EN Twist socket set
 PL Zestaw wykrętek do śrub
 DE Schraubendrehersatz
 RU Набор для извлечения обломанных болтов
 CZ Sada vyťahováku stržených šroubů
 HU Törtcsavar kiszedő készlet
 RO Set de chei pt. șuruburi
 FR Set d'extracteurs aux vis
 IT Set estrattori per dadi
 ES Juego de destornilladores
 CN 螺栓取出器组套

6 PCS 1/2" 12.7 mm CrMo

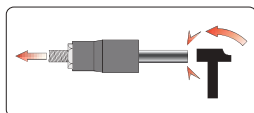

1/2" (12.5 mm): 17, 19, 21, 23, 27 mm;
 Ø 12 mm

YATO YT-06032 10

EN Screw extractor set & HSS drill bits
 PL Wykrętki do zerwanych śrub i wiertła do metalu HSS
 DE Schraubenausdrehsatz & HSS Bohrer
 RU Экстракторы и сверла по металлу HSS
 CZ Vrtáky do přetržených šroubů & vrtáky na kov HSS
 HU Törtcsavar kiszedő készlet + fúrószárak fémhez HSS
 RO Capete pt. desșurubat șuruburi rupte & burghie pt. metal HSS
 FR Set d'extracteurs aux vis
 IT Estrattori di vite HSS
 ES Destornillador para tornillos arrancados & HSS brocas
 CN 短丝取出器组套

12 PCS M3-M24 HSS

No.	Ø [mm]	M	Ø [mm]
#1	1.4 - 3.6	3 - 6	1.8
#2	2.1 - 4.9	6 - 8	2.6
#3	3.1 - 6.5	8 - 11	3.7
#4	4.8 - 8.8	11 - 14	5.5
#5	6.2 - 11.0	14 - 18	7.0
#6	9.4 - 15.0	18 - 24	10.3



YATO YT-0591 40

EN Universal extractor set
PL Uniwersalny zestaw do wykręcania
DE Gewindeausdreh-Satz
RU Набор экстракторов для болтов и гаек
CZ Nástrojová sada pro poškozené šrouby a matice
HU Szerszámkészlet sérült csavarokhoz és anyákhoz
RO Set universal de extras suruburi
FR Extracteurs universels de vis et d'écrous
IT Set universale di cacciaviti
ES Juego de extractores tornillos rotos
CN 螺丝 螺杆 螺母取出器组套

17 PCS
1/2" 12.7mm
3/8" 9.5mm
CrV 50BV30
CrMo 42

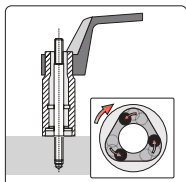

3/8" (9.5 mm): 9, 10, 11, 12, 13, 14, 16 (L=28); 19 mm (L=30); CrMo 42;
1/2" (12.5 mm): 6, 8 (L=60 mm); 10, 12 mm (L=70 mm); CrV 50BV30;
M3-M6, M6-M8, M8-M11, M11-M14, M14-M18; CrMo 42

YATO
YT-06033

10

EN Twist socket set
PL Zestaw wykrętków do śrub
DE Schraubendrehersatz
RU Набор для извлечения обломанных болтов
CZ Sada vrtákových stržených šroubů
HU Törtcsavar kiszedő készlet
RO Set de chei pt. șuruburi
FR Set d'extracteurs aux vis
IT Set estrattori per dadi
ES Juego de destornilladores
CN 螺栓取出器组套

16 PCS
CrMo 42
HRC 47-50
72T

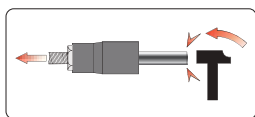

1/4", 8 mm, 3/8", 10 mm, 11 mm, 12 mm, 1/2", 13 mm, 14 mm, 16 mm, 17 mm, 11/16", 19 mm; CrMo 42;
3/8" (9.5 mm); 72T;
1/4" (6.3 mm) x 3/8" (9.5 mm);

YATO
YT-05897

10

EN Screw extractor set
PL Wykrętki do zerwanych śrub
DE Schraubenausdrehsatz
RU Набор для извлечения обломанных болтов
CZ Vrtáky do přetržených šroubů
HU Törtcsavar kiszedő készlet
RO Capete pt. deșurubat șuruburi rupte
FR Set d'extracteurs aux vis
IT Estrattori di viti
ES Destornillador para tornillos arrancados
CN 断丝取出器

5 PCS
1/4" 6.3 mm
HSS 4241



YATO
YT-06035

Ø [mm]
0-6, 1-8, 2-10, 3-12, 4-14

40

EN Universal extractor set
PL Uniwersalny zestaw do wykręcania
DE Gewindeausdreh-Satz
RU Набор экстракторов для болтов и гаек
CZ Nástrojová sada pro poškozené šrouby a matice
HU Szerszámkészlet sérült csavarokhoz és anyákhoz
RO Set universal de extras suruburi
FR Extracteurs universels de vis et d'écrous
IT Set universale di cacciaviti
ES Juego de extractores tornillos rotos
CN 螺丝螺母取出器

26 PCS
3/8" 9.5mm
CrMo 35
CrMo 42
HSS 4341
HRC 47-50



1/4", 8 mm, 3/8", 10 mm, 11 mm, 12 mm, 1/2", 13 mm, 14 mm, 16 mm, 17 mm, 11/16", 19 mm; CrMo 42;
M3-M6, M6-M8, M8-M11, M11-M14, M14-M18, M18-M24; CrMo 35;
2.5, 3.2, 4.0, 6.4, 7.2, 9.5 mm; HSS 4341;
1/4" (6.3 mm) x 3/8" (9.5 mm)

YATO
YT-05893

10

EN Universal extractor set
PL Uniwersalny zestaw do wykręcania
DE Gewindeausdreh-Satz
RU Набор инструментов для поврежденных болтов и гаек
CZ Nástrojová sada pro poškozené šrouby a matice
HU Szerszámkészlet sérült csavarokhoz és anyákhoz
RO Set extractoare suruburi si piulite
FR Etablir extracteurs suruburi si piulite
IT Set universale di cacciaviti
ES Extractores establecer vis et écrous
CN 破损螺母取出器

26 PCS
3/8" 9.5mm
HSS
CrMo 42

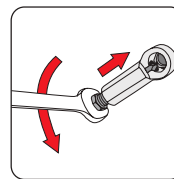

6, 8, 9, 10, 11, 12, 13, 14, 15, 16, 17, 18, 19 mm; CrMo 42;
10-19 mm, 15-29 mm; CrMo 42;
M3-M5, M4-M6, M5-M8, M6-M10, M8-M14; CrMo 42;
2.5, 3.2, 4, 6.4, 7.2 mm; HSS;
1/4" (6.3 mm), 3/8" (9.5 mm)

YATO
YT-06037

10

EN Twist socket set
PL Zestaw wykrętków do śrub
DE Schraubendrehersatz
RU Набор для извлечения обломанных болтов
CZ Sada vrtákových stržených šroubů
HU Törtcsavar kiszedő készlet
RO Set de chei pt. șuruburi
FR Set d'extracteurs aux vis
IT Set estrattori per dadi
ES Juego de destornilladores
CN 螺栓取出器组套

5 PCS
3/8" 9.5mm
CrMo



3/8" (9.5 mm): 10, 11, 13, 14, 16 mm

YATO
YT-06038

10/20

EN Screw extractor set
 PL Wykrętki do zerwanych śrub
 DE Schraubenausdrehsatz
 RU Набор для извлечения обломанных болтов
 CZ Vrtáky do přetržených šroubu
 HU Törtcsavar kiszedő készlet
 RO Capete pt. desurubat suruburi rupte
 FR Set d'extracteurs aux vis
 IT Estrattori di viti
 ES Destornillador para tornillos arrancados
 CN 断丝取出器组套



6
PCS



No.	Ø [mm]	L [mm]
#1	3-6	52
#2	6-8	58
#3	8-11	66
#4	11-14	75
#5	14-18	80
#6	18-25	88

EN Tap socket set
 PL Zestaw adapterów do gwintowników
 DE Adaptersatz für Gewindebohrer
 RU Набор адаптеров для метчиков
 CZ Sada hlavic na závrtníky
 HU Menetfűrő dugókulcs adapter készlet
 RO Set tubulare pt. tarazi
 FR Jeu d'adaplateurs pour tarauds
 IT Set di adattatori per madreviti
 ES Juego de adaptadores para machos de roscar
 CN 丝锥套筒组套

10
PCS

1/4"
6.3mm

3/8"
9.5mm



1/4" (6.3 mm): #1, #2, #3, #3.5, #4, #4.5; 3/8" (9.5 mm): #5, #6, #7, #8

YATO
YT-0590

12/48

YATO
YT-29280

1/4" (6.3 mm), 3/8" (9.5 mm) 10/40

EN Bolt extractor set
 PL Zestaw wykrętek do szpilek
 DE Satz von Ausziehvorrichtungen für Stifte
 RU Набор экстракторов для шпилек
 CZ Souprava na demontáž závrtných šroubů
 HU Csavarkihajító készlet
 RO Set de șurubelnițe pt. tije
 FR Set d'extracteurs aux épingles

EN Set bussole estrattore per brugola
 ES Juego de extractores de alfileres
 CN 断丝取出器组套

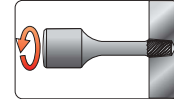

HRC
49-52

8660
HCP-CARBON STEEL
HRC: 49-52/50-53



6
PCS

3/8"
9.5mm

YATO
YT-0623

Ø [mm]
2, 3, 4, 6, 8, 10

50

5
PCS

1/2"
12.7mm

YATO
YT-0624

Ø [mm]
8, 10, 12, 14, 16

20



EN Bolt extractor set
 PL Zestaw wykrętek do szpilek
 DE Satz von Ausziehvorrichtungen für Stifte
 RU Набор экстракторов для шпилек
 CZ Souprava na demontáž závrtných šroubů
 HU Csavarkihajító készlet

RO Set de șurubelnițe pt. tije
 FR Set d'extracteurs aux épingles
 IT Set bussole estrattore per brugola
 ES Juego de extractores de alfileres
 CN 断丝取出器

10
PCS

CrMo
42

HRC
50-53



EN Bolt extractor set
 PL Zestaw wykrętek do szpilek
 DE Satz von Ausziehvorrichtungen für Stifte
 RU Набор экстракторов для шпилек
 CZ Souprava na demontáž závrtných šroubů
 HU Csavarkihajító készlet

RO Set de șurubelnițe pt. tije
 FR Set d'extracteurs aux épingles
 IT Set bussole estrattore per brugola
 ES Juego de extractores de alfileres
 CN 断丝取出器组套

25
PCS

3-23
mm

CrV
50

HRC
50-53



3, 4, 5.5, 6, 7, 8, 9, 10, 11 mm; 1/8", 5/32", 3/16", 7/32", 1/4", 9/32", 5/16", 11/32", 3/8", 13/32"

YATO
YT-05890

20



3, 4, 5, 5.5, 6, 7, 8, 9, 10, 11, 12, 13, 13.5, 14, 15, 16, 17, 17.5, 18, 19, 20, 21, 21.5, 22, 23 mm

YATO
YT-06034

10

EN Damaged bolt removal set
 PL Zestaw bitów do obrabionych śrub
 DE Schraubenausdreher-Bitsatz für beschädigte Schrauben
 RU Набор бит экстракторов для выкручивания винтов
 CZ Sada bitů pro obráběné šrouby
 HU Megmunkált csavar eltávolító készlet
 RO Set extractoare suruburi deteriorate
 FR Jeu de extracteurs de vis
 IT Kit estrattori per viti bulloni danneggiati
 ES Conjunto de puntas para tornillos desgastados
 CN 紧固件拆卸特殊六角套筒钻头组套

8
PCS



1/4"
6.3mm

3/8"
9.5mm

AISI
S2

CrV



1/4" (6.3 mm): L=38 mm; H3, H4, H5, H6; 3/8" (9.5 mm): L=50 mm; H7, H8, H9, H10

YATO
YT-04580

10/40

EN Damaged bolt removal set
 PL Zestaw bitów do obrabionych śrub
 DE Schraubenausdreher-Bitsatz für beschädigte Schrauben
 RU Набор бит экстракторов для выкручивания винтов
 CZ Sada bitů pro obráběné šrouby
 HU Megmunkált csavar eltávolító készlet
 RO Set extractoare suruburi deteriorate
 FR Jeu de extracteurs de vis
 IT Kit estrattori per viti bulloni danneggiati
 ES Conjunto de puntas para tornillos desgastados
 CN 紧固件拆卸特殊星型套筒钻头组套

7
PCS



1/4"
6.3mm

AISI
S2

CrV



1/4" (6.3 mm): L=38 mm; TE10, TE15, TE20, TE25, TE27, TE30, TE40

YATO
YT-04581

15/60

EN Heavy duty nut splitter
PL Zestaw przecinaków do nakrętek
DE Meißelsatz für Schraubenmuttern
RU Набор зубил для гаек
CZ Souprava sekáčů na matice
HU Csavaranya-vágó

RO Set relezoare capace
FR Set de burins
IT Set estrattore dado
ES Juego de tajaderas para tuercas
CN 螺母拆卸组套

4 PCS
HRC 40-45
CrV

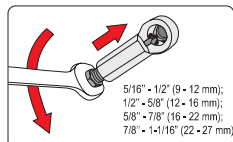

YATO
YT-0585

10

EN Roller stud extractor set
PL Zestaw wykrętków do szpilek
DE Stehbolzen-Ausdreher Satz
RU Набор ключей для снятия штифтов
CZ Vytahovací závitových šteftů
HU Komplet tükihúzó készlet
RO Set de dispozitive pt. demontaj șuruburi rupte
FR Extracteurs de goujons à rouleaux
IT Estrattori a rulli per viti prigioniere
ES Juego de extractores de espárragos
CN 螺杆取出器

No.	● [mm]	D [mm]	L [mm]	A [mm]
#1	6	24	60	21
#2	8			
#3	10	28	70	
#4	12			

4 PCS
CrV 50BV30

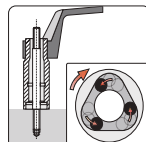
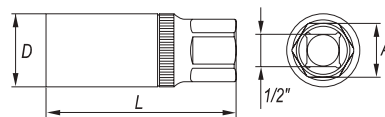

YATO
YT-0620

6/24

EN Stud extractor
PL Wykrętk do śrub szpilek i nakrętek
DE Stehbolzenausdreher
RU Шпильковерт универсальный
CZ Klíč na povolení závrtných šroubů
HU Sérültfejjű csavar kiszedő
RO Extractor pt. suruburi
FR Extracteur de goujon, écrou ou boulon arrondis
IT Stud estratore
ES Extractor de espárragos
CN 断头螺丝取出器

1/2"
12.7 mm
8.5-19 mm



YATO
YT-06251

10/30

EN Stud extractor
PL Wykrętk do śrub szpilek i nakrętek
DE Stehbolzenausdreher
RU Шпильковерт универсальный
CZ Klíč na povolení závrtných šroubů
HU Sérültfejjű csavar kiszedő
RO Extractor pt. suruburi
FR Extracteur de goujon, écrou ou boulon arrondis
IT Stud estratore
ES Extractor de espárragos
CN 断头螺丝取出器

FOR IMPACT TOOLS DO NARZĘDZI UDAROWYCH
6-11 mm
3/8" 24 mm
9.5 mm
HRC 40-45
CrMo



YATO
YT-06255

6/36

EN Stud extractor
PL Wykrętk do śrub, szpilek i nakrętek
DE Stehbolzenausdreher
RU Шпильковерт универсальный
CZ Klíč na povolení závrtných šroubů
HU Sérültfejjű csavar kiszedő
RO Extractor pt. suruburi
FR Extracteur de goujon, écrou ou boulon arrondis
IT Stud estratore
ES Extractor de espárragos
CN 断头螺丝取出器

FOR IMPACT TOOLS DO NARZĘDZI UDAROWYCH
6-11 mm
1/2" 24 mm
12.7 mm
HRC 40-45
CrMo



YATO
YT-06256

6/36

EN Tie rod end lifter
PL Ściągacz do sworzni kulistych
DE Universal-Kugelgelenk-Abzieher
RU Съёмник шаровых опор
CZ Stahovák kulových čepů řízení
HU Gömbfej kinyomó
RO Extractor pt. articulatii sferice
FR Extracteur de rotule
IT Estrattore per snodi sferici
ES Extractor de pernos esféricos
CN 球头拉拔器

19 mm 100 mm
20-60 mm Ø 20 mm
40Cr



YATO

[mm]	L [mm]	Ø [mm]	
19	100	20	20

EN Tie rod end lifter
PL Ściągacz do sworzni kulistych
DE Universal-Kugelgelenk-Abzieher
RU Съёмник шаровых опор
CZ Stahovák kulových čepů řízení
HU Gömbfej kinyomó
RO Extractor pt. articulatii sferice
FR Extracteur de rotule
IT Estrattore per snodi sferici
ES Extractor de pernos esféricos
CN 球头拉拔器

19 mm 135 mm
15-50 mm Ø 17.5 mm



YATO

[mm]	L [mm]	Ø [mm]	
19	135	17.5	9/18

EN Tie rod end lifter
PL Ściągacz do sworzni kulistych
DE Universal-Kugelgelenk-Abzieher
RU Струбцина для шаровых опор
CZ Stahovák kulových čepů řízení
HU Gömbfej kinyomó
RO Extractor pt. articulatii sferice
FR Extracteur de rotule
IT Estrattore per snodi sferici
ES Extractor de pernos esféricos
CN 球头取出器

19 mm 160 mm
35-80 mm Ø 30 mm



YATO

[mm]	L [mm]	Ø [mm]	
19	160	30	10

EN Tie rod end lifter
PL Ściągacz do sworzni kulistych
DE Universal-Kugelgelenk-Abzieher
RU Струбцина для шаровых опор
CZ Stahovák kulových čepů řízení
HU Gömbfej kinyomó
RO Extractor pt. articulatii sferice
FR Extracteur de rotule
IT Estrattore per snodi sferici
ES Extractor de pernos esféricos
CN 球头拉拔器

16 mm 265 mm 275 mm



YATO

[mm]	L [mm]	Ø [mm]	
16	265	17	20
16	275	20	20

EN Inner tie rod tool
 PL Klucz do drążków kierowniczych
 DE Spurstangengelck Lösewerkzeug
 RU Ключ для шарнира рулевой рейки
 CZ Přípravek na axiální táhla
 HU Csuikló szerelő

RO Cheia de la tija de cravată
 FR Clé pour pour rotules de direction
 IT Chiave per il tirante
 ES Extractor mecanismo de dirección
 CN 拉拔器

200
mm

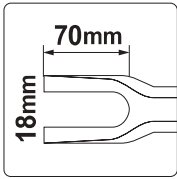

YATO	L [mm]	
YT-0615	200	18/36

EN Inner tie rod tool
 PL Klucz do drążków kierowniczych
 DE Spurstangen-Schlüssel
 RU Ключ для шарнира рулевой рейки
 CZ Přípravek na axiální táhla
 HU Axiál csukló szerelő
 RO Cheie bielete directie
 FR Clé de biellette de direction
 IT Chiave per il tirante
 ES Extractor rótulas axiales
 CN 方向机舵扳手



1/2"
12,7mm **40-47**
mm

CrMo

YATO	
YT-061602	30

EN Inner tie rod tool
 PL Klucz do drążków kierowniczych
 DE Spurstangen-Schlüssel
 RU Ключ для шарнира рулевой рейки
 CZ Přípravek na axiální táhla
 HU Axiál csukló szerelő
 RO Cheie bielete directie
 FR Clé de biellette de direction
 IT Chiave per il tirante
 ES Extractor rótulas axiales
 CN 大机舵扳手



1/2"
12,7mm **30-42**
mm

CrMo

YATO	
YT-06163	40

EN Tie rod / ball joint tool kit
 PL Ściągacze do drążków
 DE Werkzeugsatz für Bremssattel
 RU Съёмник штанг
 CZ Stahováký táhel řízení
 HU Rúdlehúzó
 RO Ancore pt. tije
 FR Set d'extracteurs pour rotules de direction
 IT Set tiranti per estrattore
 ES Tensores para palancas
 CN 汽修工具

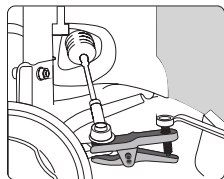

6
PCS



YATO	
YT-06157	5

EN Inner tie rod tool
 PL Klucz do drążków kierowniczych
 DE Spurstangen-Schlüssel
 RU Ключ для шарнира рулевой рейки
 CZ Přípravek na axiální táhla
 HU Axiál csukló szerelő
 RO Cheie bielete directie
 FR Clé de biellette de direction
 IT Chiave per il tirante
 ES Extractor rótulas axiales
 CN 大机舵扳手



1/2"
12,7mm **35-42**
mm

YATO	
YT-06160	25

EN Inner tie rod tool
 PL Klucz do drążków kierowniczych
 DE Spurstangen-Schlüssel
 RU Ключ для шарнира рулевой рейки
 CZ Přípravek na axiální táhla
 HU Axiál csukló szerelő
 RO Cheie bielete directie
 FR Clé de biellette de direction
 IT Chiave per il tirante
 ES Extractor rótulas axiales
 CN 双四方滤清扳手



1/2"
12,7mm **27-32**
mm

CrMo

YATO	
YT-06162	10/20

EN Track rod end remover & installer set
 PL Zestaw kluczy do drążków kierowniczych
 DE Schlüsselset für Zahnstangenlenkung
 RU Набор ключей для рулевых тяг
 CZ Sada klíčů pro říbení řízení
 HU Kormányrúd telepítő készlet-eltávolító
 RO Set montare-demontare bieleta
 FR Clé pour rotules de direction
 IT Set di chiavi suggerimenti smontaggio tiranti sterzo
 ES Herramienta de llaves para barras de dirección
 CN 轴接头工具组套



4
PCS

30-45
mm

Ø 30-35mm, 35-40mm, 40-45mm

YATO	
YT-06155	4

EN Tie rod / ball joint tool kit
 PL Ściągacze do drążków
 DE Werkzeugsatz für Bremssattel
 RU Съёмник штанг
 CZ Stahováký táhel řízení
 HU Rúdlehúzó
 RO Ancore pt. tije
 FR Set d'extracteurs pour rotules de direction
 IT Set tiranti per estrattore
 ES Tensores para palancas
 CN 球头拉拔器组套

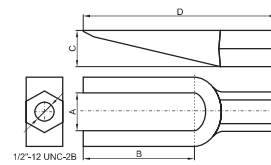

5
PCS

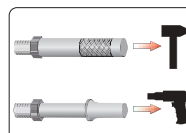

YATO	
YT-0616	10

EN Seal puller
PL Ściągacz do uszczelzek
DE Dichtungs-Abziehwerkzeug
RU Съёмник прокладок
CZ Škrabka na těsnění
HU Tömítéslehúzó

RO Ancoră pt. garnitură
FR Outil pour extraire les joints
IT Estrattore per guarnizioni
ES Tensor para juntas
CN 密封圈拉拔器

max Ø
85 mm

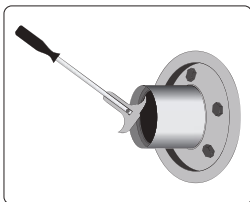

YATO 

L [mm]



YT-0642

200

12/48

EN Universal hook set
PL Zestaw haczyków z rękojeścią
DE Hakenset mit Handgriff
RU Набор крючков с рукояткой
CZ Sada háčků s rukojetí
HU Fogantyús kampó készlet

RO Set universal extractoare garnituri
FR Jeu de crochets avec manche
IT Set di ganci con maniglia
ES Set de ganchos para extracción con mango
CN 油封起子

7 PCS

162 mm

205 mm

40Cr



YATO 



YT-08425

6/24

EN Long reach hook and pick tool set
PL Zestaw haków długich z rękojeścią
DE Langhakensatz mit Griff
RU Набор длинных крючков с ручкой
CZ Sada dlouhých háků s rukojetí
HU Fogantyús hosszú kampókészlet

RO Set lung pt. extras garnituri
FR Kit de longs crochets avec poignée
IT Set di ganci lunghi con impugnatura
ES Juego de ganchos largos con mango
CN 油封起子

4 PCS

240 mm

40Cr



YATO 



YT-08429

6/72

EN Universal hook and pick set
PL Zestaw haków i skrobaków z rękojeścią
DE Haken- und Schabersatz mit Griff
RU Набор крючков и скребков с ручкой
CZ Sada háků a škrabek s rukojetí
HU Fogantyús kampó- és kaparókészlet
RO Set universal carlige extras garnituri
FR Kit de crochets et de grattoirs avec poignée
IT Set di ganci e raschiati con impugnatura
ES Juego de ganchos y raspadores con mango
CN 发动机清理工具

5 PCS

200 mm

225 mm

23x220 mm

23x245 mm

40Cr



YATO 



YT-08422

6/24

EN Universal hook set
PL Zestaw haczyków z rękojeścią
DE Hakenset mit Handgriff
RU Набор крючков с рукояткой
CZ Sada háčků s rukojetí
HU Fogantyús kampó készlet

RO Set universal extractoare garnituri
FR Jeu de crochets avec manche
IT Set di ganci con maniglia
ES Set de ganchos para extracción con mango
CN 油封起子

9 PCS

162 mm

240 mm

40Cr



YATO 



YT-08426

6/12

EN Long reach hook and pick tool set
PL Zestaw haków długich z rękojeścią
DE Langhakensatz mit Griff
RU Набор длинных крючков с ручкой
CZ Sada dlouhých háků s rukojetí
HU Fogantyús hosszú kampókészlet

RO Set lung pt. extras garnituri
FR Kit de longs crochets avec poignée
IT Set di ganci lunghi con impugnatura
ES Juego de ganchos largos con mango
CN 油封起子

6 PCS

240 mm

40Cr



YATO 



YT-08428

6/48

- EN Seal remover and hose pick set
 PL Zestaw do demontażu uszczelnień i oringów
 DE Demontageset für Dichtungen und O-Ringe
 RU Набор для снятия уплотнений и уплотнительных колец
 CZ Sada pro demontáž těsnění a těsnících kroužků
 HU O-ring és tömítésleszedő készlet

- RO Dispozitiv indepartat sigilii si set carlige
 FR Kit crochet pour joint torique
 IT Kit di strumenti per rimozione di guarnizioni e O-ring
 ES Juego de remoción de sellado y juntas tóricas
 CN 油封钩

6 PCS 120 mm
 150 mm 160 mm
 200 mm 210 mm
 290 mm
 SPECIAL SHAPE SPECJALNY KSZTAŁT



YATO
YT-08432

5

- EN Hook set for o-ring
 PL Zestaw haczyków do uszczelniaaczy
 DE Dichtungs-Haken-Satz
 RU Комплект крючков для герметиков
 HU Kampókészlet tömítésekhez

- RO Set carlige pt. o-ring
 FR Ensemble de crochet à joint d'étanchéité
 IT Set di ganci per sigillanti
 ES Set de ganchos para selladores
 CN 密封拉拔器

8 PCS
 165 mm
 225 mm
 SPECIAL SHAPE SPECJALNY KSZTAŁT



YATO
YT-08431

48

- EN Bearing and bush driver set
 PL Zestaw do osadzania łożysk i uszczelniaaczy
 DE Lager- und Buchsentreiber-Satz
 RU Набор для установки подшипников и сальников
 CZ Sada pro montáž gufer a ložisek
 HU Csapágy és szimering beütő készlet
 RO Set pt. înlocuit rulment, simering
 FR Outils pour montage des roulements et joint
 IT Set di tamponi per cuscinetti e guarnizioni
 ES Juego de conductores del anillo y del sello de rodadura
 CN 斜型培令套安装器

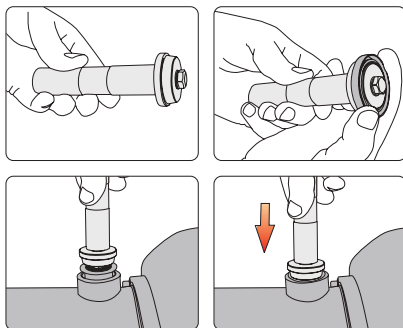

10 PCS

No.	Ø (mm)
01	40
02	44
03	50
04	59
05	63
06	65
07	72
08	76
09	81

YATO
YT-0638

5/10

- EN Bearing and bush driver set
 PL Zestaw do osadzania łożysk i uszczelniaaczy
 DE Lager- und Buchsentreiber-Satz
 RU Набор для установки подшипников и сальников
 CZ Sada pro montáž gufer a ložisek
 HU Csapágy és szimering beütő készlet
 RO Set pt. înlocuit rulment, simering
 FR Outils pour montage des roulements et joint
 IT Set di tamponi per cuscinetti e guarnizioni
 ES Juego de conductores del anillo y del sello de rodadura
 CN 斜型培令套安装器

No.	Ø (mm)	No.	Ø (mm)	No.	Ø (mm)
01	10x12	06	18x20	11	30x34
02	12x14	07	20x22	12	32x36
03	14x16	08	22x24	13	35x40
04	15x17	09	25x27	14	38x42
05	16x18	10	28x30		



17 PCS

YATO
YT-25415

10

EN Car radio removal tool set
PL Zestaw do demontażu radioodbiorników samochodowych
DE Autoradio Demontage Werkzeugsatz
RU Набор для разборки авто-ресиверов

CZ Sada k demontáži autorádií
HU Autórádió kiszereelő készlet
RO Trusa de scule pt. indepartat radio
FR Set d'outils pour dépose autoradio

IT Set estrattori per autoradio
ES Juego para el desmontaje de autorradio
CN 收音机拆卸组套

52
PCS

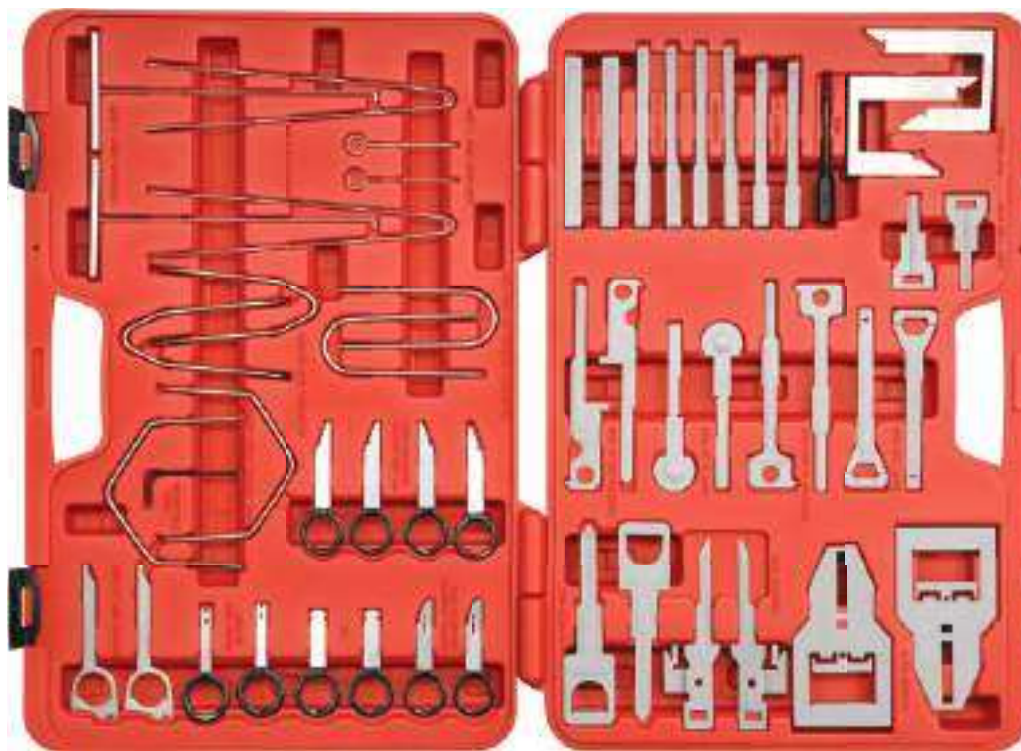

Included: radio removal keys: VW, Audi, Becker, Mercedes (4 PCS); Mercedes, Porsche, Becker (2 PCS); VW (2 PCS); new Becker (2 PCS); new Skoda (2 PCS); Fiat Brava (2 PCS); Mercedes-Benz, BMW (6 PCS); Kenwood II 1998-2001 (2 PCS); Sony II since 2002 (2 PCS); Kenwood III since 2002 (2 PCS); Pioneer, JVC (2 PCS); Sony I until 2001 (2 PCS); Panasonic (2 PCS); Kenwood I until 1998 (2 PCS); Kenwood Mask (2 PCS); new Clarion (2 PCS); old Clarion (2 PCS); Panasonic 2006 (2 PCS); Sony IDIC 2005 (2 PCS); radio removal U-hooks: Ford, VW, Audi, Grundig, Blaupunkt (2 PCS); new Blaupunkt (2 PCS); Opel (2 PCS); special pentagon wrench (BMW); allen hex wrench (BMW, Opel)

W zestawie: klucze do demontażu radia: VW, Audi, Becker, Mercedes (4 szt.); Mercedes, Porsche, Becker (2 szt.); VW (2 szt.); nowy Becker (2 szt.); nowa Skoda (2 szt.); Fiat Brava (2 szt.); Mercedes-Benz, BMW (6 szt.); Kenwood II 1998-2001 (2 szt.); Sony II od 2002 (2 szt.); Kenwood III od 2002 (2 szt.); Pioneer, JVC (2 szt.); Sony I do 2001 (2 szt.); Panasonic (2 szt.); Kenwood I do 1998 (2 szt.); Kenwood Mask (2 szt.); nowy Clarion (2 szt.); stary Clarion (2 szt.); Panasonic 2006 (2 szt.); Sony IDIC 2005 (2 szt.); haki do demontażu radia: Ford, VW, Audi, Grundig, Blaupunkt (2 szt.); nowy Blaupunkt; (2 szt.); Opel (2 szt.); specjalny klucz pięciokątny (BMW); klucz imbusowy (BMW, Opel)

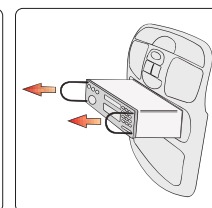
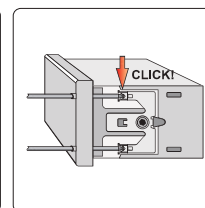
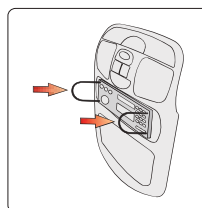

YATO
YT-0838

10

EN Door upholstery remover
PL Ściągacz do spinek tapicerci
DE Abziehvorrichtung für Polstererkammern
RU Съемник крепежа обивки

CZ Uvolňovač čalounění dveří
HU Kárpitkiszedő
RO Dispozitiv de scos agrafe de tapițerie
FR Arrache agrafes

IT Estrattore per la rimozione di graffette tappezzeria
ES Extractor de grasas de vestidura
CN 胶扣起子

SVCN



YATO Internal width / Szerokość wewnętrzna [mm] L [mm]
YT-1370 6 100 12/120

YATO Internal width / Szerokość wewnętrzna [mm] L [mm]
YT-1371 6.2 115 12/120



YATO Internal width / Szerokość wewnętrzna [mm] L [mm]
YT-1372 10 115 12/120

YATO Internal width / Szerokość wewnętrzna [mm] L [mm]
YT-1373 9.5 134 6/96

EN Scratch awl
PL Szpikuliec prosty
DE Einfache Spicknadel
RU Прямое шило
CZ Šídlo rovné
HU Spékeltűtű, egyenes

RO Dorn perforare drept
FR Brochette droite
IT Punteruolo piatto
ES Punzón recto
CN 锥子



SVCN



YATO L [mm]
YT-1374 120 12/120

EN Hook bodkin
PL Szpikuliec hakowy
DE Hakenspicknadel
RU Изогнутое шило
CZ Šídlo háčkové
HU Spékeltűtű, horgos

RO Dorn perforare îndoit
FR Brochette courbée
IT Gancio punteruolo
ES Punzón encorvado
CN 油封拉拔器

90°

SVCN





YATO L [mm]
YT-1375 125 12/120

EN Battery cap tool
 PL Ściągacz do klem akumulatora
 DE Abziehvorrichtung für Akkuklemmen
 RU Стяжка для клемм аккумулятора
 CZ Stahovák svorek akumulátoru
 HU Akkumulátor saru leghúzó

RO Extractor pt. clemă acumulator
 FR Tournevis plat pour bouchons de batterie
 IT Batteria clem estrattore
 ES Extractor para los bornes de la batería
 CN 扁铲





YATO 	Working width / Szerokość robocza [mm]	L [mm]	
YT-1378	18.5	100	12/120

EN Glass scraper
 PL Skrobak do szyb
 DE Scheibenkratzer
 RU Шабёр для скла

CZ Škrabka na okna
 HU Jégkaparó
 RO Răzuitor geamuri
 FR Gratteur pour vitres

IT Raschietto per vetro
 ES Rascador para os vidrios
 CN 刮刀





YATO 	Working width / Szerokość robocza [mm]	L [mm]	
YT-1379	39	200	6/72

EN Spare blades for glass scraper
 PL Ostrze do skrobaka do szyb
 DE Abbrechklängen
 RU Лезвия для универсальных ножей
 CZ Lomené ostří náhradní
 HU Törhető tartalékpenge

RO Lame de rezervă rupte
 FR Lames pour gratteur pour vitres
 IT Lame per raschietto
 ES Filo partido de recambio
 CN 刮刀刀片配件



For YT-1379
 Dla YT-1379

YATO 	Blade size / Rozmiar ostrza [mm]	
YT-13790	19x39	50

EN Flexible spinner handle
 PL Pokrętko elastyczne
 DE Elastischer Dreher

RU Эластичный вороток
 CZ Šroubovák ohebný
 HU Hajlékony csavarhúzó

RO Mâner flexibil
 FR Barre élastique
 IT Chiave flessibile

ES Llave flexible
 CN 套筒螺丝批



YATO 		L [mm]	
YT-1381	1/4" (6.3 mm)	150	6/96

EN Flexible magnetic bit driver
 PL Pokrętko elastyczne do bitów
 DE Elastischer Dreher für Bits

RU Эластичный вороток для разряда битов
 CZ Šroubovák ohebný na bity
 HU Hajlékony csavarhúzó, hosszú

RO Mâner flexibil pt. vârf șurubelniță
 FR Barre élastique
 IT Chiave flessibile

ES Mango flexible para desarmadores
 CN 批头螺丝批





YATO 		L [mm]	
YT-1382	1/4" (6.3 mm)	380	6/72

EN Flexible magnetic pick up tool
 PL Elastyczny uchwyt magnetyczny
 DE Elastische Magnethalterung
 RU Эластичный магнитный держатель

CZ Ohebný magnetický držák
 HU Hajlékony csavarhúzó, hosszú, mágneses
 RO Mâner magnetic flexibil
 FR Capteur magnétique

IT Mango flexible para desarmadores
 ES Mango magnético flexible
 CN 磁拾器



YATO 	L [mm]	
YT-1385	400	6/72

EN Door upholstery remover
 PL Ściągacz do spinek tapicerci
 DE Abziehvorrichtung für Polstererklammern
 RU Съемник крепежа обивки

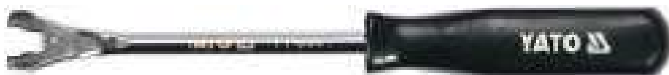

CZ Uvolňovač čalounění dveří
 HU Kárpitkiszedő
 RO Dispozitiv de scos agrafe de tapiterie
 FR Spatule d'extraction de clips

IT Estrattore per la rimozione di graffette tappezzeria
 ES Extractor de grasas de vestidura
 CN 胶扣起子



YATO 	L [mm]	
YT-0841	230	16/64



YATO 	L [mm]	
YT-0842	230	25/100

EN Panel removal set
PL Ściągacze do tapicerki
DE Abziehvorrichtung für Polsterung
RU Съёмник обивки
CZ Sada k demontáži čalounění
HU Kárpitlehűző

RO Ancore pt. tapijerie
FR Set d'extracteurs à la tapisserie
IT Leve in plastica per la tappezzeria
ES Tensores para las vestiduras
CN 面板拆卸组套

5
PCS
IMPACT
RESISTANT
ODPORNY
NA UDERZENIA
NO
SCRATCH
BEZ
ZARYSOWAŃ
NYLON



YATO
YT-0836

6/24

EN Panel removal set
PL Ściągacze do tapicerki
DE Abziehvorrichtung für Polsterung
RU Съёмник обивки
CZ Sada k demontáži čalounění
HU Kárpitlehűző

RO Ancore pt. tapijerie
FR Set d'extracteurs à la tapisserie
IT Leve in plastica per la tappezzeria
ES Tensores para las vestiduras
CN 面板拆卸组套

6
PCS
IMPACT
RESISTANT
ODPORNY
NA UDERZENIA
NO
SCRATCH
BEZ
ZARYSOWAŃ
NYLON



YATO
YT-0837

6/24

EN Panel removal set
PL Ściągacze do tapicerki
DE Abziehvorrichtung für Polsterung
RU Съёмник обивки
CZ Sada k demontáži čalounění
HU Kárpitlehűző

RO Ancore pt. tapijerie
FR Set d'extracteurs à la tapisserie
IT Leve in plastica per la tappezzeria
ES Tensores para las vestiduras
CN 面板拆卸组套

11
PCS
IMPACT
RESISTANT
ODPORNY
NA UDERZENIA
NO
SCRATCH
BEZ
ZARYSOWAŃ
NYLON



YATO
YT-0844

5/10

EN Panel removal tool kit
PL Zestaw do obsługi tapicerki
DE Servicesatz für Polsterung
RU Набор для обработки обивки
CZ Sada pro práci s čalouněním
HU Kárpitleszedő készlet

RO Kit indepartare panouri
FR Kit d'outils pour démontage de garniture de voiture
IT Kit di strumenti per tappezzeria interni
ES Juego de manipulación de tapicería
CN 汽车面板拆卸工具组套

19
PCS
IMPACT
RESISTANT
ODPORNY
NA UDERZENIA
NO
SCRATCH
BEZ
ZARYSOWAŃ
NYLON

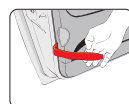

YATO
YT-08442

12

EN Panel removal set
PL Ściągacze do tapicerki
DE Abziehvorrichtung für Polsterung
RU Съёмник обивки
CZ Sada k demontáži čalounění
HU Kárpitlehűző

RO Ancore pt. tapijerie
FR Set d'extracteurs a la tapisserie
IT Leve in plastica per la tappezzeria
ES Tensores para las vestiduras
CN 撬棍

27
PCS
SCRATCH
PROOF
ODPORNE NA
ZARYSOWAŃA
NYLON



YATO
YT-08443

10

EN Scraper set
PL Zestaw skrobaków do uszczelkek
DE Dichtungsschaber-Satz
RU Набор скребков для прокладок
CZ Sada dláték do těsnění
HU Tömítés kaparó készlet

RO Set raziatoare
FR Jeu de radoirs pour joints d'étanchéité
IT Set di raschietti per la rimozione di guarnizioni
ES Juego de rascadores para juntas
CN 铲刀

3
PCS
10x270
mm
25x200
mm
25x310
mm
CrV



YATO
YT-08474

5/20

EN Plastic scraper set
PL Zestaw skrobaków plastikowych
DE Satz von Kunst-Stoffschabern
RU Набор пластмассовых шаберов
CZ Souprava plastových škrábek
HU Müanyag vakaró készlet
RO Set de răzuitoare din plastic
FR Kit de grattoirs en plastique
IT Set di raschietto
ES Juego de rascadores de plástico
CN 塑料刮刀

4
PCS
265
mm
IMPACT
RESISTANT
ODPORNY
NA UDERZENIA
NO
SCRATCH
BEZ
ZARYSOWAŃ
NYLON



3/4" (19 mm); 7/8" (22 mm); 1" (25 mm); 1 1/2" (37.5 mm)

YATO
YT-0847

L [mm]
265

6/36

EN Plastic chisel set
PL Przecinaki z tworzywa
DE Kunststoff-Meißel-Satz
RU Съёмники пластиковые панелей облицовки
CZ Plastový kln pro autoklempříře
HU Müanyag véső készlet
RO Set dalti din plastic
FR Outils pour le rembourrage de voiture
IT Scalpelli in plastica
ES Cinceles plásticos para molduras
CN 撬棍

6
PCS
NYLON



YATO
YT-08477

10/60

EN Lockout wedge set
 PL Kliny montażowe
 DE Zierleistenkeil mit Loch
 RU Клин удаления монтировки
 CZ Sada montážních klinů
 HU Szerelőék készlet
 RO Set pene de montaj
 FR Cales de montage
 IT Cunei di fissaggio
 ES Cuñas plásticas
 CN 塑料刹车块

4 PCS
 ∅ 25 mm
 100x50 x25 mm



YATO

YT-67370

12/48

EN Lockout wedge set
 PL Kliny montażowe
 DE Zierleistenkeil mit Loch
 RU Клин удаления монтировки
 CZ Sada montážních klinů
 HU Szerelőék készlet
 RO Set pene de montaj
 FR Cales de montage
 IT Cunei di fissaggio
 ES Cuñas plásticas
 CN 撬棍

5 PCS
 NYLON



YATO

YT-67371

6/24

EN Quick release cut out tool
 PL Nóż do wycinania szyby
 DE Schneidmesser für Scheiben
 RU Нож для вырезания стекла
 CZ Nůž na vyřezávání skel
 HU Szélvédőkívágó kés
 RO Cuțit țâțier de geam
 FR Kit de découpe pare-brise
 IT Tagliolo per il vetro
 ES Cuchilla para cortar cristales
 CN 玻璃橡胶刮除器

X3 BLADES
 OSTRZA
 QUICK RELEASE
 SZYBKO-ZŁACZE
 AI K5



YATO

YT-0659

20/40

EN Spare blades for cut out tool
 PL Ostrza zapasowe do noża do wycinania szyby
 DE Abbrechklingenn
 RU Лезья для ножей
 CZ Ostrí náhradní
 HU Törhető tartalékpenge
 RO Rezervă cutter
 FR Lames
 IT Lame di ricambio per coltello specialistica per tagliare vetri del auto
 ES Filo partido de recambio
 CN 玻璃橡胶刮除器刀片

X3 BLADES
 OSTRZA
 K5



For YT-0659
 Dla YT-0659

3/4" (19 mm); 1" (25 mm); 1-1/2" (38 mm)

YATO

YT-06590

10/80

EN Windshield removal set
 PL Zestaw do demontażu szyby samochodowych
 DE Demontagesatz für Autoscheiben
 RU Набор для демонтажа автостекла
 CZ Souprava na demontáž autoskel
 HU Szélvédőcserélő szett

RO Set pt. demontarea geamurilor de mașină
 FR Kit pour démontage de vitres de voiture
 IT Set di strumenti di rimozione parabrezza
 ES Juego para desmontaje de cristales de coches
 CN 风挡玻璃拆卸组套

7 PCS
 HRC 38-42



YATO

YT-0845

10

EN Windscreen wiper arm removal tool
 PL Ściągacz do ramion wycieraczek
 DE Abziehvorrichtung für Scheibenwischerarme
 RU Съемник поводков стеклоочистителя
 CZ Stahovák na ramínka stěračů
 HU Ablaktörőkár-lehúzó
 RO Siguranță pt. brațele ștergătoarelor
 FR Bord aux bras d'essuie-glace
 IT Estrattore di parabrezza tergicristallo braccio
 ES Herramienta para desmontaje de las plumas de los limpiaparabrisas
 CN 雨刷臂拆卸工具

ADJUSTABLE
 NASTAWNY
 CrMo

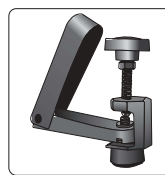

YATO

YT-0846

20/120

EN Two leg puller for widescreen wiper arms
 PL Ściągacz dwuramienny do ramion i wycieraczek
 DE Abzieher für Scheibenwischer
 RU Съемник стеклоочистителя батареи
 CZ Dvouúčňí stohovač pro ramena stěračů
 HU Kétkaros húzó az ablaktörőkárokhoz
 RO Extractor brat ștergator
 FR Extracteur d'essuie glaces
 IT Estrattore a due griffe per bracci tergicristalli
 ES Extractor tirador exterior para brazo del limpiaparabrisas
 CN 雨刷臂拉马

max 50 mm
 ADJUSTABLE
 NASTAWNY



YATO

YT-08461

15/60

EN Two leg puller for battery terminals and widescreen wiper arms
 PL Ściągacz dwuramienny do klem i ramion wycieraczek
 DE Abzieher für Wischerarm und Polklemmen
 RU Съемник стеклоочистителя терминал батареи дворники
 CZ Stahovák na svorky akumulátoru a ramen stěračů
 HU Akkusaru és ablaktörőkár-lehúzó
 RO Extractor brat ștergator, clame baterie
 FR Extracteur d'essuie glaces et cosse de batterie
 IT Estrattore a due griffe per binding post e bracci dei tergicristalli
 ES Extractor tirador exterior para brazo del limpiaparabrisas, terminal de batería
 CN 电瓶接头拉马

5-30 mm
 ADJUSTABLE
 NASTAWNY



YATO

YT-25145

∅ [mm]
 5-30

48

- EN Two leg puller for battery terminals and widescreen wiper arms
PL Ściągacz dwuramienny do klem i ramion wycieraczek
DE Abzieher für Wischermarm und Polklemmen
RU Съёмник стеклоочистителя терминал батареи дворники
CZ Stahovák na svorky akumulátorů a ramen stěračů
HU Akkusaru és ablaktörlőkar-lehűző
RO Extractor brat stergator, dema baterie
FR Extracteur d'essuie glaces et cosse de batterie
IT Estrattore a due griffe per binding post e bracci dei tergicristalli
ES Extractor tirador exterior para brazo del limpiaparabrisas, terminal de batería
CN 电瓶接头拉马



10-40 mm
ADJUSTABLE
NASTAWNY

YATO	Ø [mm]	
YT-08462	10-40	6/36

- EN Puller for ribbed drive pulley
PL Ściągacz kół pasowych wieloramienny
DE Riemenscheiben Abzieher Werkzeug Keilriemenscheiben
RU Универсальный съёмник шкива
CZ Staviteľný stahovák drážkových řemenic
HU Bordás szíjtárcsa lehűző
RO Tragator de scripete reglabil
FR Universel extracteur de poulie d'entraînement cannelé
IT Estrattore puleggia motrice a coste
ES Extractor de polea acanalada
CN 皮带轮拉马

40-165 mm
3/8" 9.5 mm
17 mm

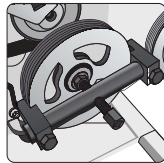

YATO	
YT-25480	10

- EN Universal pulley puller
PL Ściągacz uniwersalny do kół rozrządu
DE Universal-Riemenscheiben-Abzieher
RU Съёмник шкивов универсальный
CZ Univerzální stahovák ozubených kol
HU Univerzális szíjtárcsa lehűző
RO Extractor universal pt. roată distribuție
FR Extracteur de poulie universel
IT Estrattore universale per ruote di albero a camme
ES Extractor de poleas universal
CN 正时皮带轴承拉马

24 mm
60-90 mm
3 ARMS
8 SETTINGS
Ustawienia



YATO	
YT-06340	10

- EN Camshaft balancer puller
PL Ściągacz wałka wyrównowazajacego
DE Ausgleichwellen-Abzieher
RU Съёмник балансировочного вала
CZ Stahováč hřídele vyvažovače
HU Kiegyenlítő tengely leszedő
RO Extractor arbore cu came
FR Extracteur de roue d'équilibrage
IT Estrattore per albero di bilanciamento
ES Extractor del eje de equilibrio
CN 大众平衡轴拉拔器

3 PCS
VAG
FOR CAMSHAFT BALANCER DO WAŁKA WYRÓWNO- WAZAJĄCEGO
FOR GASOLINE ENGINES DO SILNIKÓW BENZYNOWYCH



VAG: Audi: A3 (since 2004), A4 & A5 (since 2008), TT (since 2007); Seat: Alhambra (since 2011), Altea (since 2005), Altea XL & Altea Freetrack (since 2007), Exeo (since 2009), Leon (since 2006), Toledo (since 2005); Volkswagen: Eos (since 2006), Golf (since 2004), Passat (since 2006), Passat CC (since 2009), Tiguan (since 2008)

YATO	
YT-06208	10

- EN Spring clamp remover VAG
PL Ściągacz do obejm i sprężyn VAG
DE Auspuff Federdämmen entferner / installer für VAG
RU Съёмник пружинных, хомутов систем выпуска VAG
CZ Přípravek na montáž a demontáž svorky výfuku VAG
HU Kipufogó rugó szerelő VAG
RO Dispozitiv montaj / demontaj esapament VAG
FR Tuyau d'échappement printemps pince outil de suppression pour VAG
IT Spring clamp rimozione VAG
ES Abrazadera de resorte herramienta de eliminación-para VAG
CN 弹簧撑

17 mm
VAG



YATO	
YT-25331	12/24

- EN Ballancer puller and installer
PL Ściągacz kół pasowych z tłumikiem drgań
DE Riemenscheibenabzieher mit Schwingungsdämpfer
RU Съёмник шкива виброгасителя
CZ Stahováč řemenic s tlumičem vibrací
HU Ékszíjtárcsa lehűző készlet
RO Extractor și instalator de echilibrare
FR Extracteur de poulie de courroie avec amortisseur de vibrations
IT Estrattore per puleggia con smorzatore
ES Extractor de polea de la correa de transmisión con amortiguador de vibraciones
CN 正时皮带盘拆卸器

23 PCS



YATO	
YT-25483	5

- EN Universal pulley puller
PL Ściągacz uniwersalny do kół rozrządu
DE Universal-Riemenscheiben-Abzieher
RU Съёмник шкивов универсальный
CZ Univerzální stahovák ozubených kol
HU Univerzális szíjtárcsa lehűző
RO Extractor universal pt. roată distribuție
FR Extracteur de poulie universel
IT Estrattore universale per ruote di albero a camme
ES Extractor de poleas universal
CN 正时皮带轴承拉马

17 mm
50-80 mm
3 ARMS
6 SETTINGS
Ustawienia
ADJUSTABLE
NASTAWNY



YATO	
YT-06341	10

- EN Camshaft sprocket pulley puller
PL Ściągacz kół rozrządu
DE Universal-Abzieher-Satz für Nockenwellenrad
RU Набор съёмников для шкива распределите
CZ Stahováč na řemenice vačkové hřídele
HU Vezérműtengely ékszíjtárcsa lehűző
RO Extractor fulli arbore cu camee
FR Extracteur de poulie d'arbres à cames
IT Estrattore per ruote di albero a camme
ES Extractor de poleas universal
CN 凸轮轴链轮拉马

5 PCS
17 mm
VAG



YATO	
YT-06342	8

- EN Fuel tank sender unit spanner
- PL Klucz pazurowy do pompy paliwa
- DE Tankgeberschlüssel
- RU Ключ для крышки топливного насоса
- CZ Nastavitelný klíč na šrouby palivových nádrží
- HU Üzemanyag jeladó készlet
- RO Cheie reglabila pt. pompa combustibil pe rezervor
- FR Outil de démontage de pompe
- IT Chiave smontaggio galleggiante serbatoio
- ES Llave de tres garras para aforador
- CN 油箱盖拆装工具

24 mm 75-160 mm 3 REGULATED SPRING REGULATING TORQUE



- EN Water pump removal tool set
- PL Zestaw do demontażu pompy wodnej
- DE Demontagesatz für Wasserpumpe
- RU Набор для разборки водяного насоса
- CZ Sada pro demontáž vodního čerpadla
- HU Vízszivattyú leszereő készlet
- RO Set demontat pompa de apa
- FR Kit de démontage de la pompe à eau
- IT Set per rimozione pompa d'acqua
- ES Juego para desmontar la bomba de agua
- CN 大众水泵拆卸组套

4 PCS



VW: Transporter T5, Tuareg
 AXD, AXE, BAC, BLJ, BLK, BPD, BPC, BPE (2003-)

YATO YT-06288 20

YATO YT-05390 10

- EN Transmission line disconnect tool set
- PL Zestaw do rozłączania przewodów
- DE Werkzeugsatz zum Trennen von Kraftstoffleitungen
- RU Набор для рассоединения топливopроводов
- CZ Sada na rozpojování palivového potrubí
- HU Üzemanyagcső-lebontó készlet
- RO Set pt. deconectarea liniilor de combustibil
- FR Outil de déconnexion de ligne de transmission de carburant
- IT Set per scollegare i tubi di carburante
- ES Juego para desconectar conductos de combustible
- CN 油管拆卸组套

8 PCS FOR AIR CONDITIONING DO KLIMATYZACJI FOR FUEL LINES DO PRZEWODÓW PALIWA



- EN Transmission line disconnect tool set
- PL Zestaw do rozłączania przewodów
- DE Werkzeugsatz zum Trennen von Kraftstoffleitungen
- RU Набор для рассоединения топливopроводов
- CZ Sada na rozpojování palivového potrubí
- HU Üzemanyagcső-lebontó készlet
- RO Set pt. deconectarea liniilor de combustibil
- FR Outil de déconnexion de ligne de transmission de carburant
- IT Set per scollegare i tubi di carburante
- ES Juego para desconectar conductos de combustible
- CN 油管拆卸组套

23 PCS FOR AIR CONDITIONING DO KLIMATYZACJI FOR FUEL LINES DO PRZEWODÓW PALIWA



For fuel lines / Do przewodów paliwa: 5/16" (8 mm), 3/8" (10 mm), 1/2" (12.5 mm), 5/8" (15.9 mm), 3/4" (19 mm), 7/8" (22.2 mm)
 For air conditioning / Do klimatyzacji: 3/8" (10 mm), 1/2" (12.5 mm), 5/8" (15.9 mm), 3/4" (19 mm)

YATO YT-0630 20

YATO YT-06301 10

- EN Conditioning tool set
- PL Zestaw nasadek do klimatyzacji
- DE Ansatz-Set für Klimaanlage
- RU Набор насадок для системы кондиционирования
- CZ Sada zásuvek pro klimatizaci
- HU Dugókulcs készlet klíma berendezéshez
- RO Set unelte aer conditionat
- FR Ensemble de douille pour la climatisation
- IT Kit di attacchi per impianto aria condizionata
- ES Juego de vasos para el aire acondicionado
- CN 空调修理组套

12 PCS 1/4" 6.3mm CrV



- EN Digital thermometer
- PL Termometr elektroniczny z sondą
- DE Elektronisches Thermometer mit Sonde
- RU Электронный термометр с зондом
- CZ Elektronický teploměr se sondou
- HU Elektronos hőmérő szondával
- RO Termometru digital
- FR Thermomètre électronique avec sonde
- IT Termometro elettronico con sonda
- ES Termómetro electrónico con sonda
- CN 电子数显温度计

130 mm +/-1 °C LCD °C -50 +300 1x LR44



1/4" (6.3 mm); SW12, SW15 (L=40 mm); CrV;
 1/4" (6.3 mm); 2.2, 3.2 mm (L=50 mm); CrV;
 1/4" (6.3 mm);
 1/4" (6.3 mm); TS10, TS15, TS20, TS25, TS27, TS30, TS40 (L=25 mm); CrV

YATO YT-12007 10/20

YATO YT-72971 130 250

EN Lock-ring pliers
PL Szczypce rozporowe do pierścieni osadczych
DE Spreizzange für Schellen
RU Шипцы распорные для стяжных хомутов
CZ Kleště na hadicové spony
HU Seeger fogó

RO Clește pt. desfacerea brăjarelor de strângere
FR Pince tenaille pour les bagues de retenue
IT Pinza per rondelle elastice scanalata
ES Alicates para abrazaderas
CN C 型扣钳

225
mm

CrV

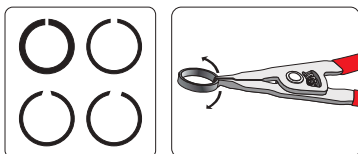

YATO 

YT-0607

L [mm]

225



12/72

EN Fuel feed pipe pliers
PL Szczypce do złączek paliwowych
DE Zange für Tankverschlüsse
RU Шипцы для топливных соединений
CZ Kleště na spojky palivového systému
HU Üzemanyagvezeték fogó
RO Clește pt. conectoare de combustibil
FR Pince tenaille pour connecteurs de carburant
IT Pinza per tubo carburante
ES Alicates para enchufes de combustible
CN 油管钳

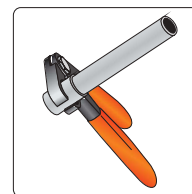

AI



YATO 

YT-0608



10

EN Fuel feed pipe remover
PL Szczypce do złączy przewodów paliwowych
DE Zange für Kraftstoffleitungen-Anschlüsse
RU Клеши для разъемов топливных магистралей
CZ Kleště do spojek palivového potrubí
HU Üzemanyagvezeték fogó
RO Extractor conducte de alimentare combustibil
FR Pince à raccord de carburant
IT Pinza per raccordi di tubi carburante
ES Pinzas para conectores de tubos de combustible
CN 汽车油管钳

235
mm

FOR FUEL LINES
DO PRZEWODÓW
PALIWA

SPECIAL
SHAPE
SPECJALNY
KSZTAŁT



YATO 

YT-06082



6/24

EN CV boot clamp pliers
PL Szczypce do opasek osłony przegubu
DE Zange für Schellen der Gelenkabdeckung
RU Шипцы для хомутов крепления кожуа шарнира
CZ Kleště na spony manžety kloubu
HU Féltepengely bilincs húzó fogó
RO Cleste siguranta burduf planetara
FR Pince pour collier à recouvrement de joint
IT Pinza a morsetto per fascette pinzabili
ES Alicates para abrazadera de protección de la junta
CN 防尘套喉箍夹钳

235
mm

CrV

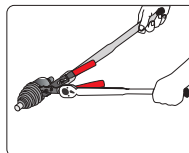
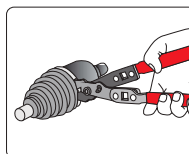

YATO 

YT-0606

L [mm]

235



6/36

EN CV boot clamp pliers
PL Szczypce do opasek osłony przegubu
DE Zange für Schellen der Gelenkabdeckung
RU Шипцы для хомутов крепления кожуа шарнира
CZ Kleště na spony manžety kloubu
HU Féltepengely bilincs húzó fogó
RO Cleste siguranta burduf planetara
FR Pince pour collier à recouvrement de joint
IT Pinza a morsetto per fascette pinzabili
ES Alicates para abrazadera de protección de la junta
CN 防尘套喉箍夹钳

245
mm



YATO 

YT-06061

L [mm]

245



6/36

EN CV boot clamp pliers
PL Szczypce do opasek osłony przegubu
DE Zange für Schellen der Gelenkabdeckung
RU Шипцы для хомутов крепления кожуа шарнира
CZ Kleště na spony manžety kloubu
HU Féltepengely bilincs húzó fogó
RO Cleste siguranta burduf planetara
FR Pince pour collier à recouvrement de joint
IT Pinza a morsetto per fascette pinzabili
ES Alicates para abrazadera de protección de la junta
CN 防尘套喉箍夹钳

3/8"
9.5mm

270
mm

0-40
mm

CrMo



YATO 

YT-06535

L [mm]

270



5/20

EN Hose clamp tool
 PL Szczypce do opasek zaciskowych
 DE Schlauchklemmen-Werkzeug
 RU Клеши натяжные для хомутов
 CZ Kleště na hadicové spony
 HU Tömélbilincs fogó
 RO Clema furtun
 FR Pince de serrage
 IT Pinza per fascette
 ES Pinza para abrazaderas
 CN 喉箍拆卸钳

3/8" 14 mm 0-40 mm

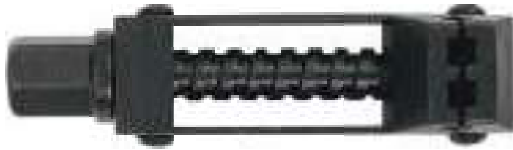

YATO
 YT-06477 3/8" (9.5 mm) 10/40

EN CV joint clamp banding tool with ratchet
 PL Szczypce do opasek przegubów napędowych z grzechotką
 DE Achsmanschetten-Klemm-Zange mit Ratsche
 RU Приспособление для установки ленточных хомутов шруса
 CZ Kleště pro montáž manžet homokinetických kloubů s ráčnou
 HU Racsnis gumiharang bilincs fogó
 RO Instrument de fixare a demelor de articulație cu clichet
 FR Pince pour colliers de soufflets de cardan avec cliquet
 IT Pinza stringi fascette per cuffie giunti omocineticici con cricchetto
 ES Alicata para abrazaderas de juntas homocinéticas con carraca
 CN 防尘套束装钳

max 10 mm CUT OFF ODDIĘCIE HARDENED STEEL STAL HARTOWANA



YATO
 YT-06064 6/36

EN Spark plug puller set VAG
 PL Zestaw ściągaczy do cewek zapłonowych VAG
 DE Abzieher-Satz Zündspulen VAG
 RU Набор съемников для катушек зажигания VAG
 CZ Sada stahováků zapalovací cívky
 HU Gyújtótekercs lehúzó készlet
 RO Set bobina de aprindere tragator
 FR Set d'extracteurs des bobines d'allumage
 IT Set per la rimozione rapida bobine di accensione nelle auto VAG
 ES Extractores bobinas de encendido grupo VAG
 CN 四件套火花塞维修工具



4 PCS
VAG

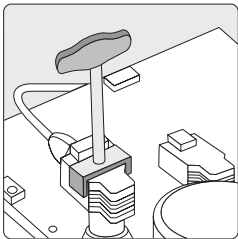

T type 1		Volkswagen FSI Golf / Bora 1998, Polo 2002, Touran 2004, New Beetle 2003, Passat 1997, T4+Audi A2 2001
T type 2		Silniki/engines 6 cyl. 24V, 5 cyl. Golf / Bora 1998, Passat / Touareg 1997, Sharan 1996, Phaeton / Toureg 6 cyl. 2003, T5 z 6 cyl. silnikiem 2004
T type 3		Volkswagen silnik / engines 2.0 z bezp. wtrysk / direct injection, Touran 2004, Passat 2006, Audi z bezp.wtrysk / direct injection A3 2.0 2004, A6 3.2 2005
T type 4		Volkswagen z bezp. wtrysk / direct injection 2.0, Golf / Touran 2004, Passat 2006, Audi z bezp. wtrysk / direct injection, A3 2.0 2004, A6 3.2 2005

EN CV joint clamp banding tool
 PL Szczypce do opasek przegubów napędowych
 DE Achsmanschetten-Klemm-Zange
 RU Клеши для хомутов шрубов
 CZ Kleště pro montáž manžet homokinetických kloubů
 HU Gumiharang bilincs fogó
 RO Cleste pt. coliere metalice
 FR Pince pour colliers de soufflets de cardan
 IT Pinza stringi fascette per cuffie giunti omocineticici
 ES Alicata para abrazaderas de juntas homocinéticas
 CN 束装钳

max 10 mm CUT OFF ODDIĘCIE HARDENED STEEL STAL HARTOWANA



YATO
 YT-06062 6/36

EN Hose removing pliers
 PL Szczypce do zdejmowania przewodów
 DE Schlauch- und Kabellösezange
 RU Клеши для снятия изоляции
 CZ Kleště na demontáž hadic
 HU Tömélbilincs fogó
 RO Clește pt. indepartat furtune
 FR Pince pour enlever les fils
 IT Pinza spelacavi universale
 ES Alicata de extracción de mangueras
 CN 油管分离钳

ø 5-15 mm 5-30 mm



YATO
 YT-0657 6/36

VW, Audi, Skoda, Seat

YATO
 YT-06205 10

- EN Multi-purpose hose & wire pliers
- PL Komplet szczypiec do opasek i przewodów
- DE Zangensatz für Schellen und Leitungen
- RU Набор щипцов к хомутам и проводам
- CZ Souprava kleští na spony a hadice
- HU Fogókészlet bilincsekhez és vezetékhez
- RO Set clește pt. benzi și conducte
- FR Pince pour collier de serrage
- IT Set pinze per il morsetto
- ES Juego de pinzas para abrazaderas y cables
- CN 多功能管夹钳



2 PCS	1/4" 6.3mm	3/4" 19mm	217 mm	254 mm	
----------	---------------	--------------	-----------	-----------	---

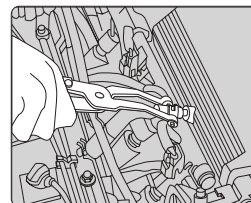

FOR ENGINE AIR PIPE
DO PRZEWODÓW POWIETRZNYCH LISTWY WTRYSKOWEJ

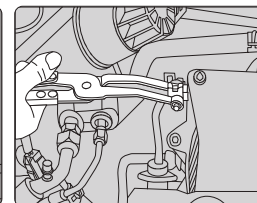

FOR ENGINE INTAKE AIR PIPE
DO PRZEWODÓW GUMOWYCH UKŁADU ZASILANIA

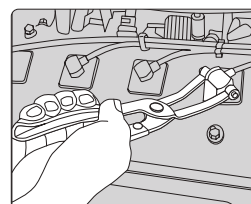

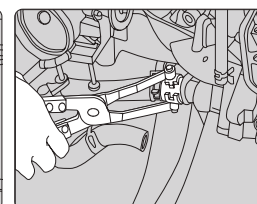

FOR SPARK PLUG LEAD
DO PRZEWODÓW ZAPŁONOWYCH



FOR COOLING WATER PIPE
DO PRZEWODÓW GUMOWYCH UKŁADU CHŁODZENIA

YATO 	L [mm]	
YT-0645	217, 254	6/24

- EN Hose clamp pliers
- PL Szczypce do opasek zaciskowych rozprężnych
- DE Zange zum Entspannen der Klemmschellen
- RU Щипцы к хомутам зажимным распорным
- CZ Kleště na samosvorné hadicové spony
- HU Vízcsőbilincs fogó
- RO Clește pt. benzile de strângere destindere
- FR Pince pour collier de serrage
- IT Set pinze per il morsetto
- ES Pinzas para las abrazaderas de expansión
- CN 管夹钳

	215 mm	∅ 2.0 mm
LOCK BLOKADA	AISI 4130	

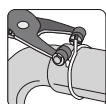

YATO 	L [mm]	
YT-0646	215	12/72

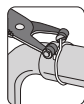

- EN Hose clamp pliers
- PL Szczypce do opasek zaciskowych rozprężnych
- DE Zange zum Entspannen der Klemmschellen
- RU Щипцы к хомутам зажимным распорным
- CZ Kleště na samosvorné hadicové spony
- HU Vízcsőbilincs fogó
- RO Clește pt. benzile de strângere destindere
- FR Pince pour collier de serrage
- IT Set pinze per il morsetto
- ES Pinzas para las abrazaderas de expansión
- CN 管夹钳

230 mm	4mm	∅12mm
HRC 40	LOCK BLOKADA	



YATO 	L [mm]	
YT-0650	230	6/36

- EN Hose clamp pliers
- PL Szczypce do opasek zaciskowych rozprężnych
- DE Zange zum Entspannen der Klemmschellen
- RU Щипцы к хомутам зажимным распорным
- CZ Kleště na samosvorné hadicové spony
- HU Vízcsőbilincs fogó
- RO Clește pt. benzile de strângere destindere
- FR Pince pour collier de serrage
- IT Set pinze per il morsetto
- ES Pinzas para las abrazaderas de expansión
- CN 管夹钳

	215 mm	∅ 4.5 mm
LOCK BLOKADA	AISI 4130	

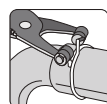

YATO 	L [mm]	
YT-0647	215	12/72

- EN Hose clamp pliers
- PL Szczypce do opasek zaciskowych rozprężnych
- DE Zange zum Entspannen der Klemmschellen
- RU Щипцы к хомутам зажимным распорным
- CZ Kleště na samosvorné hadicové spony
- HU Vízcsőbilincs fogó
- RO Clește pt. benzile de strângere destindere
- FR Pince pour collier de serrage
- IT Set pinze per il morsetto
- ES Pinzas para las abrazaderas de expansión
- CN 弯嘴管夹钳

	215 mm	4mm	∅12mm
LOCK BLOKADA	HRC 40		

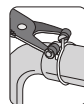

YATO 	L [mm]	
YT-0651	215	6/36

- EN Exhaust pipe clamp pliers
- PL Szczypce do opasek wydechu
- DE Auspuffschellen-Sicherungszange
- RU Щипцы для пружинных зажимов
- CZ Kleště na spony vyfuku
- HU Kipufogóbilincs fogó
- RO Clește pt. coliere teava de esapament
- FR Pince pour collier d'échappement
- IT Set pinze per il morsetto
- ES Pinzas para bridas del tubo de escape
- CN 排气管夹钳

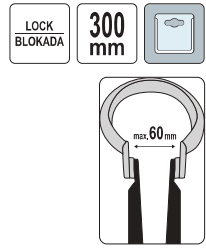

YATO	L [mm]	
YT-0652	300	10/20

Peugeot, Citroën, Renault, Fiat, Ford

- EN Valve stem seal pliers
- PL Szczypce do uszczelniaczy zaworowych, długie
- DE Lange Zange für Ventildichtringe
- RU Щипцы для замены маслосъемных колпачков
- CZ Kleště na těsnění ventilů, dlouhé
- HU Szelepszár szimering fogó hosszú

- RO Clește cu picior lung pt. sigilat supape
- FR Pince pour joints de queues de soupapes
- IT Pinza per tenuta anello stelo valvola
- ES Pinzas para juntas de vástago válvula
- CN 气门油封钳



YATO	L [mm]	
YT-0648	270	12/60

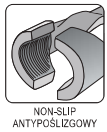

- EN Pliers for band clips with a cord
- PL Szczypce z linką do opasek zaciskowych
- DE Zange für Rohrschellen mit Seil
- RU Щипцы к зажимным хомутам с тросиком
- CZ Kleště s lankem na samosvorné hadicové spony
- HU Flexibilis bowdenes vízcsőbilincs fogó
- RO Clește pt. cleme de prindere frânghie
- FR Pince pour collier de serrage
- IT Pinza per il montaggio e lo smontaggio delle clips elastiche
- ES Pinzas para bandas de apretadura con cuerda
- CN 延长型弹性管夹钳

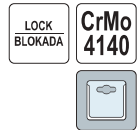

YATO	
YT-0653	12/36

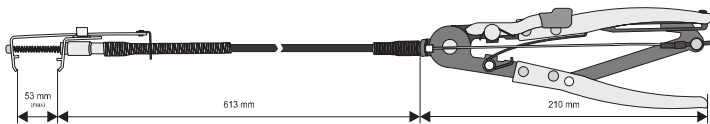

- EN Pliers for band clips with a cord
- PL Szczypce z linką do opasek zaciskowych
- DE Zange für Rohrschellen mit Seil
- RU Щипцы к зажимным хомутам с тросиком
- CZ Kleště s lankem na samosvorné hadicové spony
- HU Flexibilis bowdenes vízcsőbilincs fogó
- RO Clește pt. cleme de prindere frânghie
- FR Pince pour collier de serrage
- IT Pinza per il montaggio e lo smontaggio delle clips elastiche
- ES Pinzas para bandas de apretadura con cuerda
- CN 延长型弹性管夹钳

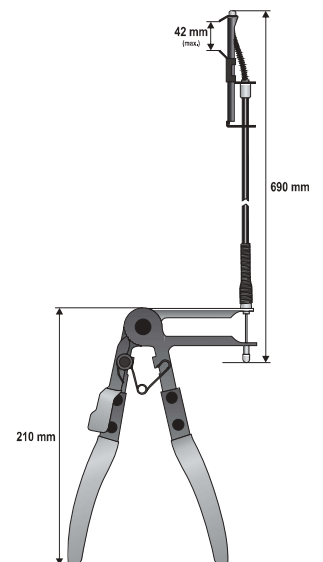

YATO	
YT-0677	25

- EN Hose clip pliers
PL Szczypce do opasek zaciskowych typu CLIC i CLIC-R
DE Schlauchklemmzange
RU Покоскобы для зажима шлангов хомуты, CLIC-R
CZ Kleště na hadicové spony
HU Tömrlébilincs fogó
RO Cleste furtun clip
FR Pince pour collier de serrage
IT Pinza per fascetta a CLIC e CLIC-R
ES Alicates abrazaderas
CN 压线钳

170 mm

CLIC
CLIC-R



YATO 	L [mm]	
YT-06475	170	10/60

- EN Tensioner pulley wrench
PL Klucz do rolki napinającej
DE Zahnriemen Spannrollenschlüssel
RU Ключ для регулировки натяжного
CZ Klíč na napínák
HU Bordás szij feszítő

- RO Cheie de pretensionare a centurilor
FR Clé pour rouleau de tension
IT Chiave per il rullo tenditore
ES Llave del tensor de la correa dentada
CN 滑轮定时扳手

32 mm



YATO 		
YT-06273		20/100

- EN Universal pulley holder & fan clutch set
PL Klucz do napinania koła pasowego
DE Schlüssel zum Spannen der Riemenscheibe
RU Ключ для натяжения шкива
CZ Klíč k napínání řemenice
HU Szijtárcsa feszítő kulcs

- RO Cheie pt. întindere roată de curea
FR Clé universelle pour poulie
IT Blocca puleggia
ES Llave tensora para polea
CN 多用途皮带轮扳手

11
PCS

∅ 6-10 mm

∅ 8-11 mm

∅ 10-12 mm

∅ 11-16 mm

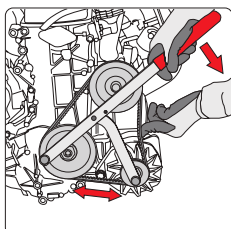

∅ 6-10 mm, ∅ 8-11 mm, ∅ 10-12 mm, ∅ 11-16 mm

YATO 		
YT-0627		8

- EN Serpentine belt tool set
PL Zestaw kluczy do napinaczy
DE Spannrollen-Schlüssel-Satz
RU Набор ключей для натяжения ремня
CZ Sada klíčů na napínací kladky
HU Ékszij feszítő kulcs készlet
RO Cheie pt. curea de distributie
FR Jeu de clés pour tendeurs
IT Set di chiavi per tendicinghia
ES Juego de llaves para tensores
CN 惰性皮带扳手调整组



8
PCS

3/8" 9.5 mm

1/2" 12.7 mm

CrV



-  3/8" (9.5 mm): 15, 16, 18 mm; CrV;
 3/8" (9.5 mm): 13, 14, 15 mm; CrV;
590 mm

YATO 		
YT-06278		6/12

- EN Timing belt double pin wrenches tool set for VAG
PL Zestaw do obsługi rolek napinaczy VAG
DE Kit für die Bedienung von VAG-Spannrollen
RU Комплект для обслуживания роликов натяжителя VAG
CZ Sada pro údržbu napínacích kladek VAG
HU VAG feszítógörgő szervizelő készlet
RO Trusa si chei de curele VAG
FR Kit d'extraction de coussinet VAG
IT Set di attrezzi per rulli tenditori VAG
ES Juego para rodillos tensores VAG
CN 大众奥迪正时皮带双销扳手套装

6
PCS

VAG



YATO 		
YT-06275		5

- EN Stretch fit belt tool kit
PL Zestaw do obsługi pasków elastycznych wielorolkowych
DE Werkzeugsatz für elastische Keilrippenriemen
RU Набор для использования гибких многоканавочных ремней
CZ Sada pro manipulaci s elastickými více drážkovými řemeny
HU Készlet több bordás ékszij kezeléséhez
RO Set catarame strangere centura scule
FR Ensemble pour le montage et démontage des courroies élastiques à nervures multiples en V
IT Kit per montaggio / smontaggio delle cinghie elastiche
ES Kit de montaje de correas elásticas ranuradas
CN 正时皮带拆装辅助器

2
PCS

FOR ELASTIC STRAPS DO PASKÓW ELASTYCZNYCH

ASSEMBLY DISASSEMBLY MONTAZ DEMONTAZ



YATO 		
YT-05830		20/80

EN Piston ring compressor
 PL Zaciskacz do pierścieni
 DE Kolbenring-Spannband
 RU Оправка поршневых колец
 CZ Svěrka na kroužky
 HU Gyűrűbepattintó
 RO Clește pt. strâns inele
 FR Compresseur de segments de piston
 IT Morsetto per anelli
 ES Apretador de anillos
 CN 活塞环压缩机



SK5 AISI 301

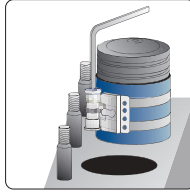

EN Piston rings pliers
 PL Szczypce do pierścieni tłokowych
 DE Kolbenringe Zange
 RU Клеști для установки поршневых колец
 CZ Klešti na pístní kroužky
 HU Dugattyűgyűrű fogók
 RO Clește pt. inelul de piston
 FR Pince pour anneau de piston
 IT Pinze per anelli di pistoni
 ES Alicates de anillo de pistón
 CN 活塞环钳

40-100 mm



YATO	Ø [mm]	H [mm]	
YT-0635	50-125	75	30/60
YT-0636	90-175	100	30/60
YT-0637	90-175	150	20/40

YATO	
YT-06377	5/50

EN Piston ring tool set
 PL Zestaw do obsługi pierścieni tłokowych
 DE Kolbenring-Wartungssatz
 RU Набор для обслуживания поршневых колец
 CZ Sada pro údržbu pístních kroužků
 HU Dugattyűgyűrű-szerelő készlet
 RO Set unelte pt. inel piston
 FR Kit d'outils d'entretien de segment de piston
 IT Set di attrezzi per fasce elastiche
 ES Kit de ensamblaje de anillos de pistón
 CN 活塞环拆装套装

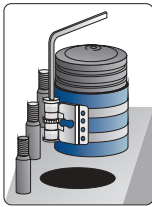

75 x 50-125 mm, 100 x 60-175 mm, 130 x 60-175 mm



10 PCS 50-100 mm

YATO	Ø [mm]	
YT-06373	50-125, 60-175, 60-175	4

EN Cylinder honing machine
 PL Honownica do cylindrów
 DE Ziehschleifmaschine für Motorenzylinder
 RU Хонинговальный станок

CZ Valcový honovací stroj
 HU Henger hönölő
 RO Mașină de honuit cilindri
 FR Machine à roder des cylindres

IT Levigatrice per cilindri
 ES Máquina herramienta para afilar los cilindros
 CN 气缸打磨器

X3 HONES KAMENE ADJUSTABLE TENSION REGULOVANY NACISK FLEXIBLE SHAFT ELASTYCZNY WALEK



19-63 mm 205 mm 28x6 mm



32-89 mm 230 mm 51x7 mm



51-177 mm 305 mm 76x10 mm

YATO	L [mm]	
YT-05810	205	50/100

YATO	L [mm]	
YT-05811	230	50/100

YATO	L [mm]	
YT-05812	305	5/20

EN Interchangeable stones for honing machine
 PL Kamienie wymienne do honownicy
 DE Wechselschleifsteine für die Ziehschleifmaschine
 RU Сменный брусок для хонинговального станка

CZ Výmenné kameny do honovacího stroje
 HU Cserélhető kövek a hönölőhoz
 RO Pietre interșanjabile pt. mașina de honuit
 FR Pierres interchangeable de la machine à roder

IT Set di pietre di ricambio per levigatrice
 ES Piedras intercambiables a la máquina herramienta para afilar cilindros
 CN 磨石

3 PCS

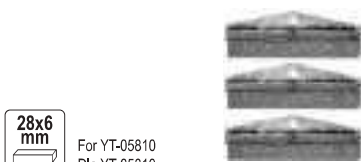

28x6 mm For YT-05810 Dla YT-05810



51x7 mm For YT-05811 Dla YT-05811



76x10 mm For YT-05812 Dla YT-05812

YATO	
YT-05815	50/200

YATO	
YT-05816	50/200

YATO	
YT-05817	50/100

- EN Cylinder hone tool set
- PL Zestaw do honowania cylindrów
- DE Zylinder-Honwerkzeug-Satz
- RU Набор для хонингования цилиндров
- CZ Sada pro honování válců
- HU Hengerhónoló készlet
- RO Kit pt. șlefuit cilindrii
- FR Jeu de pierrage de cylindres
- IT Set lappatore per cilindri
- ES Kit de lapeadores de cilindros
- CN 气缸打磨器



7 PCS	∅ 51-177 mm	FLEXIBLE SHAFT ELASTYCZNY WALEK	101x11 mm	102x11 mm
P100	P220	P400		

P100 11x102 mm (3 PCS), P220 11x101 mm (3 PCS), P400 11x101 mm (3 PCS)

YATO 	
YT-05801	10

- EN Cylinder hone tool set
- PL Zestaw do honowania cylindrów
- DE Zylinder-Honwerkzeug-Satz
- RU Набор для хонингования цилиндров
- CZ Sada pro honování válců
- HU Hengerhónoló készlet
- RO Kit pt. șlefuit cilindrii
- FR Jeu de pierrage de cylindres
- IT Set lappatore per cilindri
- ES Kit de lapeadores de cilindros
- CN 气缸打磨器



7 PCS	∅ 20-50 mm	∅ 25-70 mm	∅ 32-89 mm	∅ 51-177 mm
FLEXIBLE SHAFT ELASTYCZNY WALEK	28x5 mm	50x7 mm	76x10 mm	100x11 mm
P220				

P220 5x28 mm (5 PCS), P220 7x50 mm (3 PCS), P220 10x76 mm (3 PCS), P220 11x100 mm (3 PCS)

YATO 	
YT-05802	10

- EN Cylinder hone tool set
- PL Zestaw do honowania cylindrów
- DE Zylinder-Honwerkzeug-Satz
- RU Набор для хонингования цилиндров
- CZ Sada pro honování válců
- HU Hengerhónoló készlet
- RO Kit pt. șlefuit cilindrii
- FR Jeu de pierrage de cylindres
- IT Set lappatore per cilindri
- ES Kit de lapeadores de cilindros
- CN 气缸打磨器



14 PCS	∅ 20-50 mm	∅ 25-70 mm	∅ 32-89 mm	FLEXIBLE SHAFT ELASTYCZNY WALEK
28x5 mm	50x7 mm	P220		

P220 5x28 mm (8 PCS), P220 7x50 mm (3 PCS)

YATO 	
YT-05800	10

EN Belt gauge
 PL Przyrząd do kontroli naciągu paska rozrządu
 DE Werkzeug Spannungsprüfer
 RU Прибор для проверки натяжения ремней
 CZ Připravek pro kontrolu napnutí rozvodového řemene
 HU Méter szíjteszességet
 RO Tester întindere curea de distribuție cu gradatie
 FR Controleur de tension de courroie
 IT Strumento per il controllo rapido della tensione cinghia distribuzione
 ES Medidor para determinar la tensión de la correa
 CN 皮带张紧器

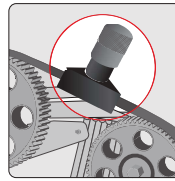

YATO
 YT-06019



20

EN Special socket antechamber injection pump
 PL Nasadka do komory wstępnej wtryskowej
 DE Kerbzahn-Einsatz für Vorkammer-Muttern an Dieselmotoren
 RU Сервисный ключ для форкамер
 CZ Klíč pro vstříkovací čerpadla
 HU Dugókulcs befecskendező szivattyúhoz
 RO Tubulatură specială pt. anticamera pompa de injecție motoare
 FR Douille spéciale pipe d'admission
 IT Bussola per precamera
 ES Llave de vaso con dentado exterior para cámara de precombustión
 CN 奔驰火花塞外齿套筒



1/2"
 12.7mm

Ø
 28 mm

MERCEDES



15/60

EN VAG high pressure pump pulley remover
 PL Ściągacz pompy wtryskowej VAG
 DE VAG Einspritzpumpenabzieher
 RU Съёмник для ТНВД VAG
 CZ Stahovák vstříkovacího čerpadla VAG
 HU VAG befecskendező szivattyú leszedő
 RO Dispozitiv de îndepărtare a fueliei pompei de înaltă presiune VAG
 FR Extracteur de pompe à injection VAG
 IT Estrattore per pompa di iniezione VAG
 ES Extractor de la bomba de inyección VAG
 CN 大众皮带盘扳手



15 mm

VAG



VAG
 1.4 I, 1.6 I, 2.0 I TDI

YATO
 YT-17527

20

YATO
 YT-12005

EN Twin cam locking tool for petrol & diesel engines
 PL Uniwersalna blokada wałków rozrządu
 DE Universelle Blockade der Steuerwellen
 RU Универсальный набор блокировки распределвала
 CZ Univerzální přípravek na zablkování rozvodných hřídelí
 HU Univerzális vezérműtengely rögzítő
 RO Dispozitiv universal blocare distributie
 FR Outil de blocage d'arbre à cames
 IT Universale strumento di bloccaggio a camme
 ES Bloqueo universal de eje de distribución
 CN 凸轮止锁工具



DOHC
 FOR DIESEL ENGINES DO SLINKŮW DIESLA
 FOR GASOLINE ENGINES DO SLINKŮW BENZYNŮWCH

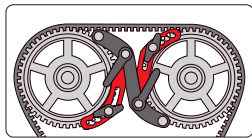

YATO
 YT-06008

10

EN Twin cam locking tool for petrol & diesel engines
 PL Uniwersalna blokada wałków rozrządu
 DE Universelle Blockade der Steuerwellen
 RU Универсальный набор блокировки распределвала
 CZ Univerzální přípravek na zablkování rozvodných hřídelí
 HU Univerzális vezérműtengely rögzítő

RO Dispozitiv universal blocare distributie
 FR Outil de blocage d'arbre à cames
 IT Universale strumento di bloccaggio a camme
 ES Bloqueo universal de eje de distribución
 CN 双凸齿轮固定器

FOR DIESEL ENGINES DO SLINKŮW DIESLA

FOR GASOLINE ENGINES DO SLINKŮW BENZYNŮWCH



EN Diesel engine locking setting kit
 PL Blokada do kół rozrządu
 DE Blockade für Steuerräder
 RU Блокировка к колесам распределительных механизмов
 CZ Souprava na fixaci rozvodových kol
 HU Diesel motor rögzítő készlet
 RO Blocadă roților distributive
 FR Outil de blocage d'arbre à cames
 IT Cinghia di distribuzione di bloccaggio
 ES Bloqueo para las poleas del mecanismo de distribución
 CN 正时皮带更换工具

3 PCS

FOR VALVETRAIN DO SLINKŮW ROZRZĄDU

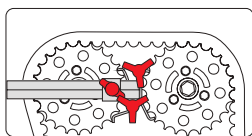
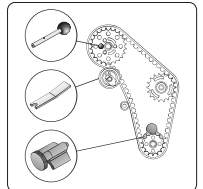

YATO
 YT-06011

10/20



VW: Lupo, Polo, Golf, Bora, Beetle, Caddy, Sharan, Touran, Transporter (1998-2006);
 Audi: A2, A3, A4, A6; Ford: Galaxy (2000-2006);
 Seat: Arosa, Ibiza, Cordoba, Leon, Toledo, Alhambra (1999-2005); Skoda: Fabia, Octavia (2000-2006)
 3 i 4 cyl 1.2, 1.4, 1.9 TDI PD, 2.0 SDI, 2.0 TDI PD

YATO
 YT-0632

10/50

EN Timing locking set
PL Zestaw blokad rozrządu
DE Nockenwellen-Arretierwerkzeugsatz
RU Комплект блокировки газораспределения
CZ Blokovačí sada pro opravu rozvodů
HU Vezérműrogtató szerszámkészlet

RO Set blocare distribuție auto
FR Jeu d'outils de calage de distribution
IT Set di bloccaggio distribuzione auto
ES Juego de bloques de distribución
CN 引擎正时工具



Peugeot: 208 1.0/1.2 VTI 2008; Citroen: C3 1.0/1.2 VTI 2012
 EBO (ZMZ), EB2 (HMZ)

YATO
YT-06023 5

EN Timing locking set
PL Zestaw blokad rozrządu
DE Nockenwellen-Arretierwerkzeugsatz
RU Комплект блокировки газораспределения
CZ Blokovačí sada pro opravu rozvodů
HU Vezérműrogtató szerszámkészlet

RO Set blocare distribuție auto
FR Jeu d'outils de calage de distribution
IT Set di bloccaggio distribuzione auto
ES Juego de bloques de distribución
CN 引擎正时工具



Renault: Twingo, Clio, Kangoo, Megane, Scenic, Laguna, Espace 1.2, 1.4, 1.6, 1.8, 2.0 16V (98-06), 1.5dCi; Nissan: Micra 1.5dCi, Kubistar 1.6 16V (03-06); Opel: Vivaro 2.0 16V (01-06)
 Renault: D4F, K4J, K4M, F4P, F4R, F4Rt, F5R740, K9K; Nissan: K9K, K4M; Opel: F4R720

YATO
YT-06014 10

EN Timing locking set
PL Zestaw blokad rozrządu
DE Nockenwellen-Arretierwerkzeugsatz
RU Комплект блокировки газораспределения

CZ Blokovačí sada pro opravu rozvodů
HU Vezérműrogtató szerszámkészlet
RO Set blocare distribuție auto
FR Jeu d'outils de calage de distribution

IT Set di bloccaggio distribuzione auto
ES Juego de bloques de distribución
CN 引擎正时工具



- Camshaft locking pin
- Crankshaft locking pin
- 2 camshaft locking clamps
- Trzpień blokujący wałek rozrządu
- Trzpień blokujący wał korbowy
- 2 zaciski blokujące wałki rozrządu

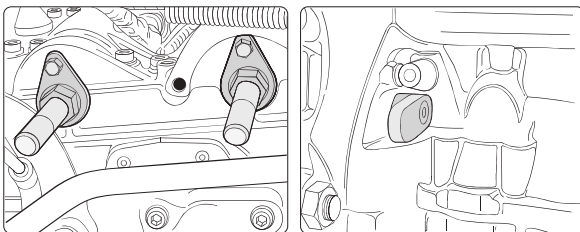

VW, Skoda, Seat 1.2 12V and 1.2 6V (HTP); VW: Polo; Seat: Ibiza, Cordoba; Skoda: Fabia HTP
 JAZQ, AWY, BMD, BME (02-07)

YATO
YT-06012 10

EN Timing locking set
PL Zestaw blokad rozrządu
DE Nockenwellen-Arretierwerkzeugsatz
RU Комплект блокировки газораспределения
CZ Blokovačí sada pro opravu rozvodů
HU Vezérműrogtató szerszámkészlet

RO Set blocare distribuție auto
FR Jeu d'outils de calage de distribution
IT Set di bloccaggio distribuzione auto
ES Juego de bloques de distribución
CN 引擎正时工具



Audi: A3 (03-10); Seat: Altea, Ibiza, Leon; Skoda: Fabia II (07-09), Octavia (04-09), Roomster (06-09), Superb (09-10); VW: Eos (06-09), Golf (03-09), Golf Plus (05-09), Jetta (06-09), Passat (05-09), Polo (02-08), Scirocco (09-10), Tiguan (07-09), Touran (03-09)
 1.4 FSI (AXU, BKG, BLN), 1.4 TFSI (BLG, BMY, BWK, CAVA, CAVB, CAVC, CAVD, CAVF, CAXA, CAXC, CDGA), 1.6 FSI (BAG, BLF, BLP, BTS)

YATO
YT-06017 10

EN Timing locking set
PL Zestaw blokad rozrządu
DE Nockenwellen-Arretierwerkzeugsatz
RU Комплект блокировки газораспределения
CZ Blokovačí sada pro opravu rozvodů
HU Vezérműrogtató szerszámkészlet

RO Set blocare distribuție auto
FR Jeu d'outils de calage de distribution
IT Set di bloccaggio distribuzione auto
ES Juego de bloques de distribución
CN 引擎正时工具

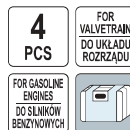



BMW: E30 318iS, E34 520i, E34 525i/525ix, E34 Serie 5, E36 318i/318iS/318ti, Z3 1.9, E36 320i, E36 Serie 3, E36 325i/325is, E36 Z3 2.2i, E36 M3, E36/7 Z3 2.5i, E36 Z3 3.0i, E36/E46 328i, E39 520i, E39 525i, E39 528i, E39 530i, E46 320i/320Ci, E46 325i/325xi, E46 325Ci, E46 325xi, E46 330i/330xi, E46 330Ci, E53 X5 3.0i, E60 530i, E60/E61 520i, E60/E61 525i/525xi, E85 Z4 2.5i, E83 X3 2.5i, E83 X3 3.0i, E85 Z4 2.2i, E85 Z4 3.0i
 M42B18, M44B19, M50B20, M50B24, M50B25, M52B21, S50B30US, M54B22, M54B25, M54B30



YATO
YT-06332 10

EN Timing locking set
 PL Zestaw blokad rozrządu
 DE Nockenwellen-Arretierwerkzeugsatz
 RU Комплект блокировки газораспределения
 CZ Blokovací sada pro opravy rozvodů
 HU Vezérműrögztítő szerszámkészlet



RO Set blocare distribuție auto
 FR Jeu d'outils de calage de distribution
 IT Set di bloccaggio distribuzione auto
 ES Juego de bloques de distribución
 CN 引擎正时工具

 Dacia: Duster (2010-2014), Logan & Logan MCV (2005-2013), Sandero (2008-2013); Nissan: Kubistar (2003-2009), Primastar (2002-2011); Opel: Vivaro (2002-2011); Renault: Avantime (2000-2003), Clio II (1998-2010), Clio III (2005-2013), Espace III (1998-2003), Espace IV (2002-2010), Kangoo (2001-2008), Kangoo II (2008-2013), Laguna (1998-2001), Laguna II (2001-2007), Laguna III (2007-2013), Megane & Megane Scenic (1999-2003), Megane II (2002-2009), Megane III (2008-2013), Modus (2004-2008), Modus & Grand Modus II (2008-2013), Scenic (1999-2003), Scenic & Grand Scenic II (2002-2009), Scenic & Grand Scenic III (2009-2013), Trafic II (2001-2011), Twingo II (2007-2014), Vel Satis (2000-2010)
 Nissan: K9K, K4M; Opel: FR4 720; Renault: D4F, K4J, K4M, F4P F4R, F4Rt, F5R740, K9K

EN Timing locking set
 PL Zestaw blokad rozrządu
 DE Nockenwellen-Arretierwerkzeugsatz
 RU Комплект блокировки газораспределения
 CZ Blokovací sada pro opravy rozvodů
 HU Vezérműrögztítő szerszámkészlet
 RO Set blocare distribuție auto
 FR Jeu d'outils de calage de distribution
 IT Set di bloccaggio distribuzione auto
 ES Juego de bloques de distribución
 CN 引擎正时工具



 Fiat: 500, Panda, Punto, Grande Punto, Albea, Linea, Bravo, Brava, Palio, Idea, Weekend, Siena, Stilo, Marea (97-10); Lancia: Ypsilon, Musa (96-10)
 1.2 16V: 176B9.000, 182B2.000, 188A5.000; 1.4 16V: 843A1.000, 169A3.000, 192B2.000, 198A1.000, 198A4.000, 199A6.000

EN Timing locking set
 PL Zestaw blokad rozrządu
 DE Nockenwellen-Arretierwerkzeugsatz
 RU Комплект блокировки газораспределения
 CZ Blokovací sada pro opravy rozvodů
 HU Vezérműrögztítő szerszámkészlet
 RO Set blocare distribuție auto
 FR Jeu d'outils de calage de distribution
 IT Set di bloccaggio distribuzione auto
 ES Juego de bloques de distribución
 CN 引擎正时工具

 Opel: Agila, Astra G/H, Corsa, Corsa B, Combo C, Meriva, Tigra B
 1.0 12V, 1.0 16V, 1.2 16V, 1.4 16 V (chain); X10XE, Z10XE, Z10XEP, X12XE, Z12XE, Z14XEP

EN Timing locking set
 PL Zestaw blokad rozrządu
 DE Nockenwellen-Arretierwerkzeugsatz
 RU Комплект блокировки газораспределения
 CZ Blokovací sada pro opravy rozvodů
 HU Vezérműrögztítő szerszámkészlet

RO Set blocare distribuție auto
 FR Jeu d'outils de calage de distribution
 IT Set di bloccaggio distribuzione auto
 ES Juego de bloques de distribución
 CN 引擎正时工具

 BMW: 520i E60 (04-08), Z4 2.0 E85 (04-08), X3 2.0i E83 (05-08), 118i E87 (04-07), 120i E87 (04-07), 316i E46 (01-05), 316 ti Compact E46 (04-05), 318i E46 (01-07), 318i Compact E46 (01-05), 318i E90 (05-08), 320i E90 (05-08), 116i E81/E87 (03-08), 316i E46/E90 (01-08), 316Ci E46 (01-05), 128i E82 (07-08), 130i E81/E87 (05-08), 135iS E82 (07-08), 323i E90/91/92/93 (04-08), 325i/xi E90/91/92/93 (04-08), 328i/xi E90/91/92/93 (04-08), 330i/xi E90/91/92/93 (04-08), 335i/xi E90/91/92/93 (05-08), 523i/Li E60/E61 (04-08), 525 i/Li/xi E60/E61 (04-08), 528i/xi E60/E61 (06-08), 530i/xi E60/E61 (05-08), 535i/xi E60/E61 (06-08), X5 3.0 E70 (06-08), Z4 2.5/3.0 E85/E6 (05-08), 630 E63/E64 (04-08), 730i/Li E65/E66 (04-08), X3 2.5/3.0 E83 (06-08); BMW Mini: R55, R56 Cooper S (06-09), R56 Mini One (07-09); Peugeot: 207, 207 CC, 308 (07-09); Citroën: C4, C4 Picasso (08-09)
 N22/B12: N24-B18A, B20A, B20B; N40/N45/N45T/B16, N51/N52/N52K/N53/N54/N53/N54 (direct injections), N12/N14: EP3 (8FS), EP6 (5FW), EP6DT (5FX), EP6DTS (5FY); OEM: OEM119280, OEM115140, OEM113340, OEM119330



YATO
 YT-06326 4

4 PCS
 FOR VALVETRAIN DO UKŁADU ROZRZĄDU
 FOR DIESEL ENGINES DO SILNIKÓW DIELSA
 FOR GASOLINE ENGINES DO SILNIKÓW BENZYNOWYCH



YATO
 YT-06016 10

5 PCS
 FOR VALVETRAIN DO UKŁADU ROZRZĄDU
 FOR GASOLINE ENGINES DO SILNIKÓW BENZYNOWYCH



YATO
 YT-06002 10

5 PCS
 FOR VALVETRAIN DO UKŁADU ROZRZĄDU
 FOR GASOLINE ENGINES DO SILNIKÓW BENZYNOWYCH



YATO
 YT-06004 5

5 PCS
 FOR VALVETRAIN DO UKŁADU ROZRZĄDU
 FOR BMW DIESEL ENGINES DO SILNIKÓW DIELSA BMW

EN Timing locking set
PL Zestaw blokad rozrządu
DE Nockenwellen-Arretierwerkzeugsatz
RU Комплект блокировки газораспределения
CZ Blokovací sada pro opravy rozvodů
HU Vezérműrögítő szerszámkészlet

RO Set blocare distribuție auto
FR Jeu d'outils de calage de distribution
IT Set di bloccaggio distribuzione auto
ES Juego de bloques de distribución
CN 引擎正时工具



6
PCS

VAG

FOR VALVETRAIN DO UKŁADU ROZRZĄDU

FOR GASOLINE ENGINES DO SILNIKÓW BENZYNOWYCH



 Audi: A3 (since 2013) 1.2/1.4 TSI; Skoda: Citigo 1.0/1.0 Ecofuel/1.0 Green Tech, Octavia (since 2013); Seat: Leon (since 2013), Mii 1.0/1.0 Ecofuel/1.0 Ecomotive; VW: Golf VII (since 2012), Jetta (since 2012), Up 1.0/1.0 BlueMotion/1.0 Ecofuel

 1.0 CHYA, CHYB, CPGA, 1.2 TFSI: CJZA, CJZB, 1.4 TFSI: CMBA, CXSA, CHPA, 1.4 TGI: CPWA, 1.4 TSI Multi Fuel CPVA, CZDA, CZDB, CZDC, 1.4 Hybrid CRJA

YATO 
YT-06025

4

EN Timing locking set
PL Zestaw blokad rozrządu
DE Nockenwellen-Arretierwerkzeugsatz
RU Комплект блокировки газораспределения
CZ Blokovací sada pro opravy rozvodů
HU Vezérműrögítő szerszámkészlet

RO Set blocare distribuție auto
FR Jeu d'outils de calage de distribution
IT Set di bloccaggio distribuzione auto
ES Juego de bloques de distribución
CN 引擎正时工具



6
PCS

VAG

FOR VALVETRAIN DO UKŁADU ROZRZĄDU

FOR GASOLINE ENGINES DO SILNIKÓW BENZYNOWYCH



 Fiat: 500, Panda, Punto (10-16)
 312 A2 000, 312 A4 000, 312 A6 000, 199 B6 000 etc.

YATO 
YT-06331

10

EN Timing locking set
PL Zestaw blokad rozrządu
DE Nockenwellen-Arretierwerkzeugsatz
RU Комплект блокировки газораспределения
CZ Blokovací sada pro opravy rozvodů
HU Vezérműrögítő szerszámkészlet

RO Set blocare distribuție auto
FR Jeu d'outils de calage de distribution
IT Set di bloccaggio distribuzione auto
ES Juego de bloques de distribución
CN 引擎正时工具



6
PCS

VAG

FOR VALVETRAIN DO UKŁADU ROZRZĄDU

FOR DIESEL ENGINES DO SILNIKÓW DIELSA



 Audi: A1, A1 Sportback, A3, A3 Cabrio, A3 Saloon, A3 Sportback, A4, A4 Allroad, A4 Quattro, A5, A5 Cabriolet, A5 Coupe, A5 Sportback, A6, TT, Q3, Q5; Seat: Alhambra, Ibiza, Leon, Leon ST; Skoda: Fabia III, Fabia III Estate, Octavia III, Rapid, Rapid Spaceback, Superb III; VW: Golf VI, Golf VII, Golf VII Estate, Golf VII SV/Sportsvan, Passat, Polo, Scirocco, Sharan II, Touran II, Tiguan

 1.4: CUSA, CUSB, CUTA; 1.6: CLHA, CLHB, CRKA, CRKB, CXXA, CXXB; 2.0: CKFB, CKFC, CRBC, CRBD, CRFA, CRFC, CRMB, CRLB, CRLC, CRVA, CRVC, CUAA, CUNA, CUPA, CUUA, CUUB, CUWA, DDAA, CNHA, CNHC, CSUA, CSUB, CSUD, CSUE

YATO 
YT-060176

10

EN Timing locking set
PL Zestaw blokad rozrządu
DE Nockenwellen-Arretierwerkzeugsatz
RU Комплект блокировки газораспределения
CZ Blokovací sada pro opravy rozvodů
HU Vezérműrögítő szerszámkészlet

RO Set blocare distribuție auto
FR Jeu d'outils de calage de distribution
IT Set di bloccaggio distribuzione auto
ES Juego de bloques de distribución
CN 引擎正时工具



6
PCS

VAG

FOR VALVETRAIN DO UKŁADU ROZRZĄDU

FOR DIESEL ENGINES DO SILNIKÓW DIELSA



 Opel: Astra, Vectra, Signum, Zafira, 1.9 CDTi (04-06); Fiat: 1.9, 2.4 JTD; 16V, 20V; Alfa Romeo: 147, 156, GT 1.9 JTD 16V, 2.4 JTD 20V

 Z19DTH, Z19DT, 192 A5.000, 192 B1.000, 937 A4.000, 937 A5.000



YATO 
YT-06013



10

- EN Timing locking set
- PL Zestaw blokad rozrządu
- DE Nockenwellen-Arretierwerkzeugsatz
- RU Комплект блокировки газораспределения
- CZ Blokovací sada pro opravu rozvodů
- HU Vezérműrogzító szerszámkészlet
- RO Set blocare distribuție auto
- FR Jeu d'outils de calage de distribution
- IT Set di bloccaggio distribuzione auto
- ES Juego de bloques de distribución
- CN 引擎正时工具



6 PCS	1/2" 12.7mm
FOR VALVETRAIN DO UKŁADU ROZRZĄDU	FOR DIESEL ENGINES DO ŚLNIKÓW DIEŚLA
	



 BMW: Serie 1 (E81, E82, E87, E88, F20), Serie 3 (E90, E91, E92, E93, F30), Serie 5 (E60, E61, F10, F11), X1 (E84), X3 (E83, F25)
 2.0 N47, N47S (2007-2010)

YATO 	
YT-06018	10

- EN Timing locking set
- PL Zestaw blokad rozrządu
- DE Nockenwellen-Arretierwerkzeugsatz
- RU Комплект блокировки газораспределения
- CZ Blokovací sada pro opravu rozvodů
- HU Vezérműrogzító szerszámkészlet
- RO Set blocare distribuție auto
- FR Jeu d'outils de calage de distribution
- IT Set di bloccaggio distribuzione auto
- ES Juego de bloques de distribución
- CN 引擎正时工具



7 PCS	FOR VALVETRAIN DO UKŁADU ROZRZĄDU
FOR GASOLINE ENGINES DO ŚLNIKÓW BENZYNOWYCH	



 Opel: Adam, Ampera, Astra J, Corsa D, Meriva B, Mokka, Zafira C Tourer; Chevrolet: Aveo
 1.0 A10 XEP, 1.2 A12 XEL, 1.2 A12 XER, 1.4 A14 XFL, 1.4 A14 XEL, 1.4 A14 XER, 1.4 A14 NEL, 1.4 A14 NET



YATO 	
YT-06009	5

- EN Timing locking set
- PL Zestaw blokad rozrządu
- DE Nockenwellen-Arretierwerkzeugsatz
- RU Комплект блокировки газораспределения
- CZ Blokovací sada pro opravu rozvodů
- HU Vezérműrogzító szerszámkészlet
- RO Set blocare distribuție auto
- FR Jeu d'outils de calage de distribution
- IT Set di bloccaggio distribuzione auto
- ES Juego de bloques de distribución
- CN 引擎正时工具



7 PCS	FOR VALVETRAIN DO UKŁADU ROZRZĄDU
FOR GASOLINE ENGINES DO ŚLNIKÓW BENZYNOWYCH	



 Opel: Astra G, H, Corsa D, Meriva (06-08), Vectra (06-08), Signum (06-08), Zafira (03-08); Chevrolet: Cruze, Orlando 1.4, 1.6, 1.8; Fiat: Croma; Alfa Romeo: 159
 Opel: 1.6-Z16LEL, Z16LER, Z16LET, Z16XE, Z16XER, 1.8-Z18XER; Chevrolet, Fiat, Alfa Romeo: 939A4.000

YATO 	
YT-06005	10

- EN Timing locking set
- PL Zestaw blokad rozrządu
- DE Nockenwellen-Arretierwerkzeugsatz
- RU Комплект блокировки газораспределения
- CZ Blokovací sada pro opravu rozvodů
- HU Vezérműrogzító szerszámkészlet
- RO Set blocare distribuție auto
- FR Jeu d'outils de calage de distribution
- IT Set di bloccaggio distribuzione auto
- ES Juego de bloques de distribución
- CN 引擎正时工具



7 PCS	FOR VALVETRAIN DO UKŁADU ROZRZĄDU
FOR GASOLINE ENGINES DO ŚLNIKÓW BENZYNOWYCH	

 Ford: B-Max (since 2010), C-Max (03-12), Fiesta (since 2013), Galaxy (since 2010), Focus (04-15), Grand C-Max (since 2010), Kuga (since 2013), Mondeo (since 2010), S-Max (since 2010), Tourneo Connect (since 2013), Transit Connect (since 2013); Volvo: S60 Cross Country T4 (11-15), S80 GTDi T3 (10-15), V40 GTDi T4 (12-15), V60 GTDi T4F (11-15), V70 T2/T3/T4 (10-15)
 HXJA, HXJB, HXDA, IQDA, IQDB, PNBA, RHBA, SIDA, 1.6T-VCT FFV, PNDA, JTWB, JTWA, JTDB, JTDA, JQDB, JQDA, IQJA, B4164T4, B4164T3, B4164T2, B4164T, JQMA, JQMB, JTMA, XTDA, MUDA, JTJA, JTBA, JTBB, KGBA, JQGA

YATO 	
YT-06029	5

EN Timing locking set
PL Zestaw blokad rozrządu
DE Nockenwellen-Arretierwerkzeugsatz
RU Комплект блокировки газораспределения
CZ Blokovačí sada pro opravy rozvodů
HU Vezérműrögztítő szerszámkészlet

RO Set blocare distribuție auto
FR Jeu d'outils de calage de distribution
IT Set di bloccaggio distribuzione auto
ES Juego de bloques de distribución
CN 引擎正时工具

 BMW: 2.0 d & 3.0 d: 118d E8 & 120d E87 (2003-2007), 318d/td E46/E90/E91 (2000-2008), 320d E46/E90/E91 (1997-2008), 320d E46/E90/E91 (1997-2008), 325d E90/91/92/93 (2006-2010), 330d E46/E90/91/92/93 & 330d E46/E90/91/92/93 & 330d E46/E90/91/92/93 (1998-2008), 335d E90/91/92 (2006-2010), 520d E39/E60/61 (1999-2010), 525d E39/E60/61 (1999-2010), 525xd E39/E60/61 (1999-2010), 530d E39/E60/61 (1998-2010), 530xd (E39/E60/61 (1998-2010), 535d E60/61 (2004-2010), 635d E63/E64 (2004-2010), 730d E38/E65/66 (1998-2008), X3 2.0d E83 (2003-2007), X3 3.0d E83 (2003-2010), X5 3.0d E53/E70 (2000-2010); Land Rover: Freelander 2.0 Td4 (2000-2006); Land Rover/Range Rover: 3.0 Td6 (2002-2006); Opel: Omega B (2001-2003)
 M47, M47TU, M47T2, M57, M57TU, M57TU2, Y25DT





7
PCS
FOR VALVE TRAIN DO UKŁADU ROZRZĄDU
FOR DIESEL ENGINES DO SILNIKÓW DIELSA 

YATO 
YT-06333  5

EN Timing locking set
PL Zestaw blokad rozrządu
DE Nockenwellen-Arretierwerkzeugsatz
RU Комплект блокировки газораспределения
CZ Blokovačí sada pro opravy rozvodů
HU Vezérműrögztítő szerszámkészlet

RO Set blocare distribuție auto
FR Jeu d'outils de calage de distribution
IT Set di bloccaggio distribuzione auto
ES Juego de bloques de distribución
CN 引擎正时工具

 Opel; Renault: Clio, Espace, Kangoo, Master, Megane, Safrane, Scenic, Spider, R5, R9, R11, R19, R21, R25, Trafic, Twingo
 Opel: DF7, E5F, E6J, E7F, E7J, K7M, F1N, F2N+R, F3N, F3P, F3R, J6R, J5T, J6R, J7R, J7T, DF4, F7P, F7R, F8M, F8Q, F9Q, J8S, G8T, S8U, S9U, S9W; Renault: 1.2, 1.4, 1.6, 1.7, 1.8, 2.0, 2.2, 1.2 16 V, 1.8 16 V, 2.0 16 V, 1.9 D, 1.9 TD, 1.9 dTi, 2.1 D, 2.1 Turbo, 2.2 D, 2.2 TD, 2.5 D, 2.5 TD, 2.8 D, 2.8 Turbo



7
PCS
FOR VALVE TRAIN DO UKŁADU ROZRZĄDU
FOR DIESEL ENGINES DO SILNIKÓW DIELSA
FOR GASOLINE ENGINES DO SILNIKÓW BENZYNOWYCH 

YATO 
YT-06325  10

EN Timing locking set
PL Zestaw blokad rozrządu
DE Nockenwellen-Arretierwerkzeugsatz
RU Комплект блокировки газораспределения
CZ Blokovačí sada pro opravy rozvodů
HU Vezérműrögztítő szerszámkészlet

RO Set blocare distribuție auto
FR Jeu d'outils de calage de distribution
IT Set di bloccaggio distribuzione auto
ES Juego de bloques de distribución
CN 引擎正时工具

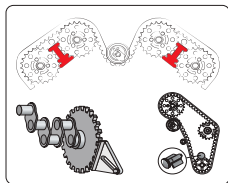

 Citroen: Berlingo 1.9 D, Dispatch 1.9 D/TD-FSO 1.9 D, Relay 1.9 D/TD, Synergie 1.9/2.0 T, Santia 1.9/2.0 D/TD/HDI, Xsara 1.9/2.0 D/HDI, ZX 1.9 D/TD, most diesels; Fiat: Ducato 2.0 D, Ulysse 1.8/2.0 Turbo; Ford: most diesels; Isuzu: 1.5/1.7 diesel engines; Opel: Astra G 1.4/1.6/1.8 16V (>1994), 1.7 TD, 2.0 16 V, Calibra 2.5/2.5i/2.6 V6, Cavalier 2.5i V6, Omega B 2.5/2.6/3.0/3.2 V6, Sintra 3.0 V6, Vectra 1.6, 1.8/2.0 16V (>1995), A 2.5i/2.6 V6, Zafira 1.6/1.8 16V; 1.6/1.7 diesel engines, 1.2/1.4/1.6/1.8/2.0 OHC petrol engines; Peugeot: 205 1.6/1.8/1.9 D, 305 1.6/1.8/1.9 D, 306 1.8/1.9 D/TD, 309 1.6/1.9 D-4.5 1.6/1.9D, 406 1.9 D, 605 2.0 D/TD, 806 1.9T D, Boxer 1.9/2.0 D/TD, Expert 1.9 D, Partner 1.9 D, Talbot (Express D, Horizon D-J5 D, Solara); Rover: 25 1.4/1.6/1.8/VVC, 45 1.4/1.6/1.8, 75 1.8, 200 Vi, 214 16V, 216 16V/Cabrio/Coupe, 218 Coupe, 414 16V, 416 16V, BRM 1.8VV; Volkswagen: Bora 1.9 TDI, Gdf 1.9 TDI, Lupo 1.2/1.4/3.0 TDI, Polo 1.4 TDI, Passat 1.9 TDI





8
PCS
AI 

YATO 
YT-0633  16

EN Timing locking set
PL Zestaw blokad rozrządu
DE Nockenwellen-Arretierwerkzeugsatz
RU Комплект блокировки газораспределения
CZ Blokovačí sada pro opravy rozvodů
HU Vezérműrögztítő szerszámkészlet
RO Set blocare distribuție auto
FR Jeu d'outils de calage de distribution
IT Set di bloccaggio distribuzione auto
ES Juego de bloques de distribución
CN 引擎正时工具

RO Set blocare distribuție auto
FR Jeu d'outils de calage de distribution
IT Set di bloccaggio distribuzione auto
ES Juego de bloques de distribución
CN 引擎正时工具

 Ford: Galaxy 2.0, Focus 2.0, Mondeo, S-Max 2.0
 MGDA, TNBA, TNWA, TNWB, TPBA, TPWA, XQDA



8
PCS
FOR GASOLINE ENGINES DO SILNIKÓW BENZYNOWYCH 

YATO 
YT-06026  5

- EN Timing locking set
- PL Zestaw blokad rozrządu
- DE Nockenwellen-Arretierwerkzeugsatz
- RU Комплект блокировки газораспределения
- CZ Blokovací sada pro opravy rozvodů
- HU Vezérműörgzőlő szerszámkészlet
- RO Set blocare distributie auto
- FR Jeu d'outils de calage de distribution
- IT Set di bloccaggio distribuzione auto
- ES Juego de bloques de distribución
- CN 引擎正时工具

 Ford: B-Max (12-15), C-Max (03-07), C-Max (07-10), C-Max (10-15), Fiesta (08-15), Focus (04-15), Galaxy (10-15), Grand C-Max (10-15), Kuga (13-15), Touneo Connect (13-15), Grand Touneo Connect (13-15), S-Max (10-15), Transit Connect (13-15); Mazda: 5 (CW) (10-15), 6 (GH) (10-13); Volvo: S60 (10-11); S80 (09-14), V40 Cross Country (10-14), V60 (10-14), V70 (09-14), XC60 (09-14)

 1.6: B4164T, B4164T2, B4164T3, HXDA, HXDB, HXJA, HXJB, IQDA, IQDB, IQJA, IQDA, JQDB, JQGA, JQMA, JQMB, JQDA, JQDB, JTJA, JTMA, JTVB, MUDA, PNDA, RVJA, SIDA, U5JA, XTDA; 2.0: B4204T6, B4204T7, B4204T7 (MZRDIDSI), MGDAB, MZR2.0 (LF), R9DA, TNBA, TNBB, TNVA, TPBA, TPWA, ZQDA



YATO
YT-06028

8
PCS

FOR VALVETRAIN DO UKŁADU ROZRZĄDU

FOR GASOLINE ENGINES DO ŚLNIKÓW BENZYNOWYCH



- EN Timing locking set
- PL Zestaw blokad rozrządu
- DE Nockenwellen-Arretierwerkzeugsatz
- RU Комплект блокировки газораспределения
- CZ Blokovací sada pro opravy rozvodů
- HU Vezérműörgzőlő szerszámkészlet
- RO Set blocare distributie auto
- FR Jeu d'outils de calage de distribution
- IT Set di bloccaggio distribuzione auto
- ES Juego de bloques de distribución
- CN 引擎正时工具

 VAG: Audi: A3 (03-10); Seat: Altea, Ibiza, Leon; Skoda: Fabia II (07-09), Octavia (04-09), Roomster (06-09), Superb (09-10); VW: Eos (06-09), Golf (03-09), Golf Plus (05-09), Jetta (06-09), Passat (05-09), Polo (02-08), Scirocco (09-10), Tiguan (07-09), Touran (03-09)

 1.4 FSI: AXU, BKG, BLN; 1.4 TFSI: BLG, BMY, BWK, CAVA, CAVB, CAVC, CAVD, CAVF, CAXA, CAXC, CDGA; 1.6 FSI: BAG, BLF, BLP, BTS



YATO
YT-06328

8
PCS

+/-
0.01
mm

VAG

FOR VALVETRAIN DO UKŁADU ROZRZĄDU

FOR GASOLINE ENGINES DO ŚLNIKÓW BENZYNOWYCH



- EN Timing locking set
- PL Zestaw blokad rozrządu
- DE Nockenwellen-Arretierwerkzeugsatz
- RU Комплект блокировки газораспределения
- CZ Blokovací sada pro opravy rozvodů
- HU Vezérműörgzőlő szerszámkészlet
- RO Set blocare distributie auto
- FR Jeu d'outils de calage de distribution
- IT Set di bloccaggio distribuzione auto
- ES Juego de bloques de distribución
- CN 引擎正时工具

 Fiat: Ducato 1.9D / TD, Punto 1.7D / TD, Tempra 1.9TD, Tipo 1.9D

 149B1.000, 160A6.000, 160A7.000, 160D1.000, 176A3.000, 176A5.000, 176B3.000, 230A2.000, 230A3.000, 230A4.000, 280A1.000



YATO
YT-06323

8
PCS

FOR VALVETRAIN DO UKŁADU ROZRZĄDU

FOR DIESEL ENGINES DO ŚLNIKÓW DIESLA



- EN Timing locking set
- PL Zestaw blokad rozrządu
- DE Nockenwellen-Arretierwerkzeugsatz
- RU Комплект блокировки газораспределения
- CZ Blokovací sada pro opravy rozvodů
- HU Vezérműörgzőlő szerszámkészlet
- RO Set blocare distributie auto
- FR Jeu d'outils de calage de distribution
- IT Set di bloccaggio distribuzione auto
- ES Juego de bloques de distribución
- CN 引擎正时工具



YATO
YT-06022

9
PCS

FOR VALVETRAIN DO UKŁADU ROZRZĄDU

FOR GASOLINE ENGINES DO ŚLNIKÓW BENZYNOWYCH



 BMW: 316i, 316i Compact, 318i, 320i, 323i, 325i, 328i, 330i, 518i, 520i, 523i, 525i, 528i, 728i, 730i

 M52TU, M54, M56, M40, M42, M43, M44, M50, M52

- EN Timing locking set
- PL Zestaw blokad rozrządu
- DE Nockenwellen-Arretierwerkzeugsatz
- RU Комплект блокировки газораспределения
- CZ Blokovačí sada pro opravy rozvodů
- HU Vezérműrögítő szerszámkészlet
- RO Set blocare distribuție auto
- FR Jeu d'outils de calage de distribution
- IT Set di bloccaggio distribuzione auto
- ES Juego de bloques de distribución
- CN 引擎正时工具





9
PCS

FOR VALVETRAIN
DO UKŁADU
ROZRZĄDU

FOR GASOLINE
ENGINES
DO SILNIKÓW
BENZYNOWYCH



 Citro II, Megane / Scenic, Megane II, Scenic II, Laguna, Laguna II, Espace (since 1998)
 1.8 16 V F4P 720, 722, 760; 2.0 Turbo 16 V F4R 700, 701, 712, 713, 714, 715, 720, 722, 730, 732, 740, 741, 744, 746, 770, 771, 776, 780, 784, 786, 787, 790, 791, 792, 794, 795, 796, 797, 820, 830

YATO 
YT-06327

5

- EN Timing locking set
- PL Zestaw blokad rozrządu
- DE Nockenwellen-Arretierwerkzeugsatz
- RU Комплект блокировки газораспределения
- CZ Blokovačí sada pro opravy rozvodů
- HU Vezérműrögítő szerszámkészlet
- RO Set blocare distribuție auto
- FR Jeu d'outils de calage de distribution
- IT Set di bloccaggio distribuzione auto
- ES Juego de bloques de distribución
- CN 引擎正时工具





9
PCS

FOR VALVETRAIN
DO UKŁADU
ROZRZĄDU

FOR GASOLINE
ENGINES
DO SILNIKÓW
BENZYNOWYCH



 Ford: Cougar, Fiesta/Courier, Focus/C-Max, Fusion, Galaxy, Mondeo, Puma, S-Max, Touneo Connect, Transit Connect
 IQDA, IQDB, JQDA, JQDB, JQGA, IQJA, JQMA, JQMB, JTBA, JTBB, JTDA, JTDB, JTJA, JTMA, JTWA, JTWB, KGBA, MUDA, PNDA, XTDA

YATO 
YT-060261

10

- EN Timing locking set
- PL Zestaw blokad rozrządu
- DE Nockenwellen-Arretierwerkzeugsatz
- RU Комплект блокировки газораспределения
- CZ Blokovačí sada pro opravy rozvodů
- HU Vezérműrögítő szerszámkészlet
- RO Set blocare distribuție auto
- FR Jeu d'outils de calage de distribution
- IT Set di bloccaggio distribuzione auto
- ES Juego de bloques de distribución
- CN 引擎正时工具



9
PCS

FOR VALVETRAIN
DO UKŁADU
ROZRZĄDU

FOR DIESEL
ENGINES
DO SILNIKÓW
DIELSA



 Nissan: Primastar (2006-), Qashqai (2007-); Renault: Espace/Grand Espace (2006-), Grand Scenic II (2006-), Koleos (2008-), Laguna II (2005-), Laguna III (2007-), Latitude (2010-), Megane II (2006-), Megane III (2009-), Scenic, Trafic (2008-), Vel Satis (2005-)
 Nissan: NV400 (2011-); 2.3 CDTi R9M, X-Trial (2007-); 2.0 DCi M9R; Opel: Movano B (2010-); 2.3 CDTi, Vivaro (2006-); 2.0 CDTi/ecoFlex; Renault: Grand Scenic III (2009-); 2.0DCi M9R, Master III (2010-); 2.3 DCi M9T

YATO 
YT-06010

5

EN Timing locking set
 PL Zestaw blokad rozrządu
 DE Nockenwellen-Arretierwerkzeugsatz
 RU Комплект блокировки газораспределения
 CZ Blokovací sada pro opravy rozvodů
 HU Vezérműrögző szerszámkészlet
 RO Set blocare distribuție auto
 FR Jeu d'outils de calage de distribution
 IT Set di bloccaggio distribuzione auto
 ES Juego de bloques de distribución
 CN 引擎正时工具

 Citroën: EP3C (8F01), EP6C (5F01), EP3 (8FS), EP6 (5FW), EP6DT (5FX), EP6CDT (5F04); Peugeot: EP3 (8FS), EP6 (5FW), EP6C (5F01), EP6DT (5FX), EP6DTS (5FY), EP3C (8F01), EP6DTX (5FU), EP6DTS (5FY), EP6CDT (5F04), EP6 (5FX), EP6CDTX (5FU); BMW Mini: N12 1.4 Valvetronic (1.4 VTI, 1.5 VTI), N14 1.6 Direkteinspritzer (1.6 THP); BMW: 1.4 VTI, 1.5 VTI, N14 (1.6 THP)





10
PCS

FOR VALVETRAIN DO UKŁADU ROZRZĄDU

FOR GASOLINE ENGINES DO SILNIKÓW BENZYNOWYCH



YATO 

YT-06001 

5

EN Timing locking set
 PL Zestaw blokad rozrządu
 DE Nockenwellen-Arretierwerkzeugsatz
 RU Комплект блокировки газораспределения
 CZ Blokovací sada pro opravy rozvodů
 HU Vezérműrögző szerszámkészlet
 RO Set blocare distribuție auto
 FR Jeu d'outils de calage de distribution
 IT Set di bloccaggio distribuzione auto
 ES Juego de bloques de distribución
 CN 引擎正时工具

 Audi: A1/A1 Sportback, A3 Cabrio, A3 Saloon, A3 Sedan, A3/A3 Sportback, A4, Allroad, A4 Quattro, A4/A5 Sportback, A5 Cabriolet, A5 Coupe, A6, TT, Q3, Q5; Seat: Alhambra, Ibiza, Leon, Leon ST; Skoda: Fabia III, Fabia III Estate, Rapid, Rapid Spaceback, Octavia III, Superb III; VW: Golf VI, Golf VII, Golf VII Estate, Golf VII SV/Sportsvan, Golf VII Wagon, Passat, Polo, Scirocco, Sharan II, Touran II, Tiguan

 1.4: CUSA, CUSB, CUTA; 1.6: CLHA, CLHB, CRKA, CRKB, CXXA, CXXB; 2.0: CKFB, CKFC, CNHA, CNHC, CRBC, CRBD, CRFA, CRFC, CRLB, CRLC, CRMB, CRVA, CRVC, CSUA, CSUB, CSUD, CSUE, CUAA, CUNA, CUPA, CUUA, CUUB, CUWA, DDAA; OEM#: T10490, T10492, T10051, 3359, T10060A, T10264, T10265



10
PCS

VAG

FOR VALVETRAIN DO UKŁADU ROZRZĄDU

FOR DIESEL ENGINES DO SILNIKÓW DIESLA





YATO 

YT-060175 

5

EN Timing locking set
 PL Zestaw blokad rozrządu
 DE Nockenwellen-Arretierwerkzeugsatz
 RU Комплект блокировки газораспределения
 CZ Blokovací sada pro opravy rozvodů
 HU Vezérműrögző szerszámkészlet
 RO Set blocare distribuție auto
 FR Jeu d'outils de calage de distribution
 IT Set di bloccaggio distribuzione auto
 ES Juego de bloques de distribución
 CN 引擎正时工具

 Mercedes: A-Class (2012-2018), B-Class (2012-2019), C-Class (2009-2018), CLA Coupe (2013-2019), CLS (2011-2018), E-Class (2009-2016), GLA (2014-2020>), GLC (2015-2019), GLE (2015-2019), GLK (2008-2015), M-Class (2011-2015), S-Class (2010-2013), S-Class (2013-2017), SLC (2016-2017), SLK (2012-2016), Sprinter (2009-2020>), Vito/Viano (2010-2015), Vito/V-Class (2014-2020>)

 M651: 1.8 (651.901), 2.1 (651.XXX), 2.2 (651.925), ENE (651.925)



11
PCS

FOR MERCEDES DO MERCEDESA

FOR VALVETRAIN DO UKŁADU ROZRZĄDU

FOR DIESEL ENGINES DO SILNIKÓW DIESLA



YATO 

YT-06322 

5

EN Timing locking set
 PL Zestaw blokad rozrządu
 DE Nockenwellen-Arretierwerkzeugsatz
 RU Комплект блокировки газораспределения
 CZ Blokovací sada pro opravy rozvodů
 HU Vezérműrögző szerszámkészlet
 RO Set blocare distribuție auto
 FR Jeu d'outils de calage de distribution
 IT Set di bloccaggio distribuzione auto
 ES Juego de bloques de distribución
 CN 引擎正时工具

 Ford: 1.3 TDCi; Fiat: Punto 1.3 JTD Multi-Jet (2003-2007), Panda, Idea, Doblo: 1.3 JTD Multi (2003-2009); Suzuki: Ignis, Wagon, Swift: 1.3 CDTi (2003-2010); Opel: Corsa C, Combo C, Astra H, Tigra B, Meriva (2003-2009)

 188A9.000, 169A1.000, 188A8.000, 188A9.000, Z13DT, Z13DTJ



12
PCS

FOR VALVETRAIN DO UKŁADU ROZRZĄDU

FOR DIESEL ENGINES DO SILNIKÓW DIESLA



YATO 

YT-06003 

5

EN Timing locking set
PL Zestaw blokad rozrządu
DE Nockenwellen-Arretierwerkzeugsatz
RU Комплект блокировки газораспределения
CZ Blokovací sada pro opravy rozvodů
HU Vezérműrögztítő szerszámkészlet
RO Set blocare distribuție auto
FR Jeu d'outils de calage de distribution
IT Set di bloccaggio distribuzione auto
ES Juego de bloques de distribución
CN 引擎正时工具

 Renault: Avantime (2005-2007), Clio (2001-2008), Espace (2000-2008), Kangoo (2000-2008), Laguna (1999-2001), Laguna II (2004-2007), Master (2000-2006), Megane (1999-2008), Modus (2004-2008), Scenic (1999-2008), Traffic (2001-2008), Twingo (2007-2008); Nissan: Almera N16 (2002-2006), Interstar (2002-2006), Kubistar (2003-2008), Micra K12 (2003-2008), Note (2006-2008), Primastar (2002-2007), Primera P12 (2003-2007), Qashqai (2008-2009); Opel: Movano (2000-2008), Vivaro (2001-2008)
 1.5 (K9K), 1.9 (F9Q), 2.2 (G9T), 2.5 (G9U)



12
PCS



FOR VALVETRAIN DO UKŁADU ROZRZĄDU

FOR DIESEL ENGINES DO SILNIKÓW DIESLA



YATO 
YT-06006  8

EN Timing locking set
PL Zestaw blokad rozrządu
DE Nockenwellen-Arretierwerkzeugsatz
RU Комплект блокировки газораспределения
CZ Blokovací sada pro opravy rozvodů
HU Vezérműrögztítő szerszámkészlet
RO Set blocare distribuție auto
FR Jeu d'outils de calage de distribution
IT Set di bloccaggio distribuzione auto
ES Juego de bloques de distribución
CN 引擎正时工具

 Ford: Fiesta, Puma, Focus (1998-2008), Focus C-Max, Escort, Orion, Mondeo (1998-2000), Cougar, Courier, Transit, Fusion, Sierra, Sierra, Toumeo (1983-2000), Connect; Mazda: 1.8D (199-1999), 121 (1995-2000), 2 (2002-2007), 3 (2003-), 5 (2005-), 6 (2002-), MX-5 (2005-), MPV (2002-2005), Tribute (2001-2004); Volvo: S40 (2004-2010), V50 (2004-2010), C30 (2006-2010)
 Diesel 1.8 D / TD, 1.8 Di, 1.8 TDCI, 2.5 Di / TD / TDCI / Turbo, 1.25 16 V, 1.4 16 V, 1.6 16 V, 1.8 16 V, 2.0 16 V, 2.3 16 V; C9DC, F9DA/B, FFDA, C9DA/B, BHDA/B, BHPA, HCPA, HCPB, P7PA, P9PA, R2PA, R3PA, RWPA, KKDA, G6DA, G6DB, G6DC, RTN, RTP, RTQ, RFK, RFN, RKD, RTJ, RTK, 4EB, 4EC, 4ED, 4FA, 4FB, 4FC, 4FD, 4GA, 4GB, 4GC, 4GD, 4GE, 4HB, 4HC, DHA, FUJA, FUJB, FXJA, FXJB, FYJA, L8, LF, YF, L3



12
PCS

FOR VALVETRAIN DO UKŁADU ROZRZĄDU

FOR DIESEL ENGINES DO SILNIKÓW DIESLA

FOR GASOLINE ENGINES DO SILNIKÓW BENZYNOWYCH



YATO 
YT-06021  4

EN Timing locking set
PL Zestaw blokad rozrządu
DE Nockenwellen-Arretierwerkzeugsatz
RU Комплект блокировки газораспределения
CZ Blokovací sada pro opravy rozvodů
HU Vezérműrögztítő szerszámkészlet
RO Set blocare distribuție auto
FR Jeu d'outils de calage de distribution
IT Set di bloccaggio distribuzione auto
ES Juego de bloques de distribución
CN 引擎正时工具

 Chevrolet: Captiva; Opel: Antara, Astra, Insignia; Saab: 9-5
 2.0: LHU/A20NFT, LTG/A20NHT, LDK/A20NHT; 2.4: LE5, LE9, A24XE, A24XF



14
PCS



FOR VALVETRAIN DO UKŁADU ROZRZĄDU

FOR GASOLINE ENGINES DO SILNIKÓW BENZYNOWYCH



YATO 
YT-06027  5

EN Timing locking set
PL Zestaw blokad rozrządu
DE Nockenwellen-Arretierwerkzeugsatz
RU Комплект блокировки газораспределения
CZ Blokovací sada pro opravy rozvodů
HU Vezérműrögztítő szerszámkészlet
RO Set blocare distribuție auto
FR Jeu d'outils de calage de distribution
IT Set di bloccaggio distribuzione auto
ES Juego de bloques de distribución
CN 引擎正时工具

 Audi: A3 (8P7), A4 (8K2/8K5), A5 (8T3), Q5, TT (8J3); Seat: Alhambra (710); Skoda: Octavia (1Z3/1Z5), Superb II; VW: Beetle (5C1/5C7), Jetta III+IV, Passat (3C5/CC)
 2006-2014 TSI, TFSI (1.8/2.0): CEAA, CGMA, CCZA, CCZB, CCZC, CCZD, CCUA, CAEB, BYJ, BYE, CDA, CDAB, CDNC, CDZA, CADA, CPSA



16
PCS

VAG

FOR VALVETRAIN DO UKŁADU ROZRZĄDU

FOR GASOLINE ENGINES DO SILNIKÓW BENZYNOWYCH



YATO 
YT-06024  5

- EN Timing locking set
- PL Zestaw blokad rozrządu
- DE Nockenwellen-Arretierwerkzeugsatz
- RU Комплект блокировки газораспределения
- CZ Blokovací sada pro opravy rozvodů
- HU Vezérműörgítő szerszámkészlet
- RO Set blocare distributie auto
- FR Jeu d'outils de calage de distribution
- IT Set di bloccaggio distribuzione auto
- ES Juego de bloques de distribución
- CN 引擎正时工具



16 PCS	FOR VALVETRAIN DO UKŁADU ROZRZĄDU
FOR GASOLINE ENGINES DO SILNIKÓW BENZYNOWYCH	

 Ford: B-Max, C-Max, EcoSport, Fiesta, Focus, Grand C-Max, Tourneo Connect, Transit Courier, Transit Connect
1.0 EcoBoost: M1DA, M1JA, M2DA, M2GA, P4JA, P4JB, SFJA, SFJB, XMJA, XMJB

YATO 	
YT-060262	2

- EN Timing locking set
- PL Zestaw blokad rozrządu
- DE Nockenwellen-Arretierwerkzeugsatz
- RU Комплект блокировки газораспределения
- CZ Blokovací sada pro opravy rozvodů
- HU Vezérműörgítő szerszámkészlet
- RO Set blocare distributie auto
- FR Jeu d'outils de calage de distribution
- IT Set di bloccaggio distribuzione auto
- ES Juego de bloques de distribución
- CN 引擎正时工具



17 PCS	FOR VALVETRAIN DO UKŁADU ROZRZĄDU
FOR DIESEL ENGINES DO SILNIKÓW DZIEŁA	FOR GASOLINE ENGINES DO SILNIKÓW BENZYNOWYCH
	

 Renault: Clio 1.2/1.4, 1.4/1.6/1.8 16V, Clio Sport 2.0 16V R19 1.4, Clio Williams 2.0 16V R19 1.4 Eco, Espace 2.0 R19 1.8 16V, 2.0 16V, 2.2 TD, Express 1.4, Extra 1.4, Kangoo 1.2/1.4, Laguna 1.6 16V, 1.8/2.0, 1.8/2.0 16V, 2.2 D/TD, 2.5 D/TD, Megane 1.4/1.6/2.0 16V, 2.5D/TD, Rapid 1.4, Safrane 2.0 16V, 2.2 TD, 2.5 20V, Scenic 1.4/1.6/2.0 16V, Trafic 2.5D, Twingo 1.2

YATO 	
YT-06324	4

- EN Timing locking set
- PL Zestaw blokad rozrządu
- DE Nockenwellen-Arretierwerkzeugsatz
- RU Комплект блокировки газораспределения
- CZ Blokovací sada pro opravy rozvodů
- HU Vezérműörgítő szerszámkészlet
- RO Set blocare distributie auto
- FR Jeu d'outils de calage de distribution
- IT Set di bloccaggio distribuzione auto
- ES Juego de bloques de distribución
- CN 引擎正时工具



29 PCS	FOR VALVETRAIN DO UKŁADU ROZRZĄDU
FOR DIESEL ENGINES DO SILNIKÓW DZIEŁA	FOR GASOLINE ENGINES DO SILNIKÓW BENZYNOWYCH
	

 Opel: Agila, Combo C, Corsa, Frontiera, Omega, Sintra, Tigra, Vectra, Zafira
1.3 CDTI 16V, 1.9 CDTI, 2.0 DTI, 2.2 DTI, 1.0 DTI, 1.0 IZU, 1.2 16V (since 1996), 1.4 16V, 1.6 16V, 1.8 16V, 2.0 16V, 2.2 16V (since 1995)

YATO 	
YT-06007	2

- EN Timing locking set
- PL Zestaw blokad rozrządu
- DE Nockenwellen-Arretierwerkzeugsatz
- RU Комплект блокировки газораспределения
- CZ Blokovací sada pro opravy rozvodů
- HU Vezérműrögziítő szerszámkészlet
- RO Set blocare distribuție auto
- FR Jeu d'outils de calage de distribution
- IT Set di bloccaggio distribuzione auto
- ES Juego de bloques de distribución
- CN 引擎正时工具



34
PCS

VAG 

YATO  
YT-06015 4

- EN Injector seat cleaning brush set
- PL Zestaw szczotek do gniazd wtryskiwaczy
- DE Injektorsitz Bürsten
- RU Ерши для чистки гнезд свечей зажигания и форсунок
- CZ Sada kartáčků na čištění sedel vstříkovačů
- HU Befecskendező fészek tisztító készlet
- RO Perii cilindrice pt. curatarea gaurilor
- FR Brosses pour puits d'injecteurs
- IT Set di spazzole per la pulizia della sede dell'iniettore
- ES Juego de cepillos para limpieza de inyectores
- CN 钢丝刷



20
PCS



150
mm

1/4"
6.3mm

SS
STAINLESS STEEL
STAL NIERDZEWNA

BRASS
MOSIADZ

NYLON 

YATO  
YT-08195 Ø [mm] 20
9, 11, 13, 15, 17, 19

Ø 9, 11, 13, 15, 17, 19 mm

- EN Injector seat cleaning brush set
- PL Zestaw szczotek do gniazd wtryskiwaczy
- DE Injektorsitz Bürsten
- RU Ерши для чистки гнезд свечей зажигания и форсунок
- CZ Sada kartáčků na čištění sedel vstříkovačů
- HU Befecskendező fészek tisztító készlet
- RO Perii cilindrice pt. curatarea gaurilor
- FR Brosses pour puits d'injecteurs
- IT Set di spazzole per la pulizia della sede dell'iniettore
- ES Juego de cepillos para limpieza de inyectores
- CN 钢丝刷组套



38
PCS



150
mm

1/4"
6.3mm

SS
STAINLESS STEEL
STAL NIERDZEWNA

BRASS
MOSIADZ

NYLON 

YATO  
YT-08196 Ø [mm] 10
8, 9, 10, 11, 12, 13, 14, 15, 16, 17, 18, 19

Ø 8, 9, 10, 11, 12, 13, 14, 15, 16, 17, 18, 19 mm

- EN Diesel injector puller
- PL Ściągacz bezwładnościowy do wtryskiwaczy
- DE Stoßabziehvorrichtung für Einspritzdüse
- RU Ударный съемник форсунок
- CZ Rázový vyťahovač vstříkovačů
- HU Diesel porlasztó kieszedő
- RO Dispozitiv de scos injectoare
- FR Extracteur à choc d'injecteurs
- IT Martello scorrevole per la rimozione degli iniettori
- ES Tuerca tensora de impacto para inyectores
- CN 柴油喷油嘴拔取器



M8 M12 M14

BOSCH
TYPE

LUCAS
TYPE 

YATO  
YT-0617 20

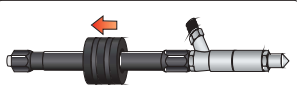

- EN Injector puller
- PL Zestaw do demontażu wtryskiwaczy
- DE Set zum Abmontieren von Einspritzdüsen
- RU Комплект для снятия форсунок
- CZ Souprava pro demontáž vstřikovačů
- HU Befecskendező készlet
- RO Extractor injectoare
- FR Ensemble pour démonter les injecteur
- IT Kit per estrazione iniettori
- ES Kit de desmontaje de inyectores
- CN 雪铁龙-标致柴油嘴拆装工具

10 PCS **HDI** **BOSCH SIEMENS**



- EN Injector puller set CDI
- PL Ściągacz do wtrysków CDI
- DE Diesel-Injektoren-Auszieher-Satz CDI
- RU Съёмник дизельных форсунок CDI
- CZ Vytahovák vstřikovačů s úderovým kladivem CDI
- HU Porlasztó kihúzó készlet csúszó kalapáccsal CDI motorhoz
- RO Set extractor pt. injectoare cu ciocan inertial pt. motoare CDI
- FR Coffret extracteur d'injecteur diesel CDI
- IT Estrattore iniettori per Mercedes CDI
- ES Juego 8 piezas de extracción de inyectores en CDI
- CN 柴油喷嘴拆卸工具

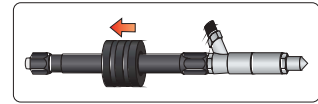

8 PCS



Mercedes: CDI OM611, OM612, OM613

YATO
YT-05338

4

YATO
YT-06176

5

- EN Diesel injector master removal set
- PL Zestaw ściągaczy bezwładnościowych do wtryskiwaczy
- DE Injektor Auszieher Abzieher Werkzeug Einspritzdüsen
- RU Съёмник форсунок с ударным молотком для дизельных двигателей
- CZ Souprava na demontáž vstřikovaču s reverzním kladivem
- HU Injektor kihúzó készlet, csúszókalapáccsal
- RO Set de extractoare inertiiale pt. injectoare
- FR Coffret extracteur d'injecteur
- IT Set di estrattori ad ineria per iniettori
- ES Extractor de inyectores de inyección
- CN 柴油喷嘴维修工具



14 PCS **1/2"** **12.7 mm**
BOSCH DELPHI DENSO SIEMENS

YATO
YT-06174

2

- EN Diesel injector master removal kit
- PL Zestaw ściągaczy bezwładnościowych do wtryskiwaczy
- DE Injektor Auszieher Abzieher Werkzeug Einspritzdüsen
- RU Съёмник форсунок с ударным молотком для дизельных двигателей
- CZ Souprava na demontáž vstřikovaču s reverzním kladivem
- HU Injektor kihúzó készlet, csúszókalapáccsal
- RO Set de extractoare inertiiale pt. injectoare
- FR Coffret extracteur d'injecteur
- IT Set di estrattori ad ineria per iniettori
- ES Extractor de inyectores de inyección
- CN 柴油喷嘴维修工具

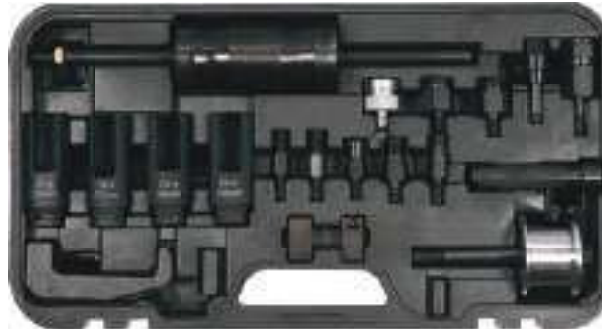

22 PCS **1/2"** **12.7 mm** **BOSCH DELPHI DENSO SIEMENS**
PUMP PUSE DIESEL INJECTORS POMPY WTRYSKIWACZY **2** **HAMMERS MŁOTY**

YATO
YT-06175

1

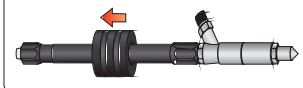

- EN Injector seat cleaning set
- PL Zestaw do czyszczenia gniazd wtryskiwaczy
- DE Einspritzdüsen-Reinigungsset
- RU Набор для чистки инжектора
- CZ Sada na čištění dosedacích sedel vstřikovačů
- HU Befecskendező fészek tisztító készlet
- RO Set de curățare scaun injector
- FR Kit de nettoyage pour injecteurs
- IT Kit per pulizia sedi iniettori
- ES Juego de limpieza para asientos de inyectores
- CN 喷油器插座清洁组套



19 PCS **1/4"** **6.3 mm** **SS** **STAINLESS STEEL STAŁ NIERDZEWIA**
NYLON **BRASS MOSIĄDZ**

YATO
YT-17623

10

Brass: Ø 17, 20, 23 mm; Nylon: Ø 16, 17, 18 mm; Steel: Ø 7 mm
Mosiądz: Ø 17, 20, 23 mm; Nylon: Ø 16, 17, 18 mm; Stał: Ø 7 mm

- EN Injector seat cleaning set
PL Zestaw do czyszczenia gniazd wtryskiwaczy
DE Einspritzdüsen-Reinigungsset
RU Набор для чистки инжектора
CZ Sada na čištění dosedacích sedel vstřikovačů
HU Befecskendező fészek tisztító készlet
RO Set de curățare scaun injector
FR Kit de nettoyage pour injecteurs
IT Kit per pulizia sedi iniettori
ES Juego de limpieza para asientos de inyectores
CN 清洁刷套装





YATO 
YT-17622

25

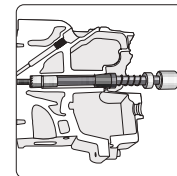
- EN Injector seat and manhole cleaning set
PL Zestaw do obsługi gniazd wtryskiwaczy
DE Wartungssatz für Einspritzdüsen
RU Набор для обслуживания патрубков форсунок
CZ Sada pro údržbu hřízd vstřikovače
HU Befecskendező-ajlízat szerelőkészlet
RO Set curățare scaun injector și gura de vizitare
FR Kit de montage et démontage d'injecteurs
IT Set per pulizia sedi iniettori
ES Juego para casquillos de inyectores
CN 喷嘴底座清理工具



 17x17 mm, 17x19 mm;
 120° 17x17 mm

YATO 
YT-17627

4

- EN Diesel injector copper washer remover install tool
PL Przyrząd do wyciągania podkładek wtryskiwaczy
DE Ausziehvorrichtung für Einspritzdüsenunterlagen
RU Инструмент для снятия шайб форсунок
CZ Nástroj pro demontáž podložek vstřikovačů
HU Befecskendező alátét eltávolító szerszám
RO Instrument instalare / extragere injector diesel
FR Extracteur d'injecteur diesel
IT Estrattore per rondelle iniettori
ES Herramienta para quitar arandelas de inyectores
CN 柴油喷嘴垫片拆卸器



YATO 
YT-17629

10

- EN Glow plug reamer set
PL Zestaw do czyszczenia gniazd świec żarowych
DE Reinigungsset für Glühkerzen
RU Набор для чистки свечей накаливания
CZ Sada k čištění otvorů zážehových svíček
HU Gyújtógyertya aljzat tisztító készlet
RO Set de curățat și rectificat filete pt. buji incandescente
FR Kit de nettoyage des puits de bougie de préchauffage
IT Kit per pulizia delle bussole delle candele
ES Set de limpieza de asientos de bujías incandescentes
CN 热塞铰刀组套

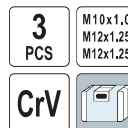

M10 x 1 mm; M12 x 1.25 mm; M12 x 1.25 mm

YATO 
YT-05341

10/20

- EN Glow plug reamer set
PL Zestaw do czyszczenia gniazd świec żarowych
DE Reinigungsset für Glühkerzen
RU Набор для чистки свечей накаливания
CZ Sada k čištění otvorů zážehových svíček
HU Gyújtógyertya aljzat tisztító készlet
RO Set de curățat și rectificat filete pt. buji incandescente
FR Kit de nettoyage des puits de bougie de préchauffage
IT Kit per pulizia delle bussole delle candele
ES Set de limpieza de asientos de bujías incandescentes
CN 预热塞螺纹修复组套



YATO 
YT-17712

10

- EN Glow plug puller set
PL Zestaw do demontażu uszkodzonej świecy żarowej
DE Demontagesatz für beschädigte Glühkerzen
RU Набор для снятия поврежденных свечей накаливания
CZ Sada pro demontáž poškozené žhavicí svíčky
HU Izzítógyertya kiszereelő készlet
RO Set extractor buji incandescente
FR Kit de démontage d'une bougie de préchauffage défectueuse
IT Set per rimozione candele danneggiate
ES Juego de desmontaje de la bujía dañada
CN 预热塞拆卸器

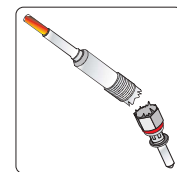

YATO 
YT-05343

5

EN Broken glow plug removal set
 PL Zestaw do demontażu urwaných świec żarowych
 DE Glühkerzen-Demontage-Werkzeug-Satz
 RU Набор инструментов для демонтажа свечей накаливания
 CZ Přípravek pro odvrtání a opravu závitů žhavicích svíček
 HU Törött izzítógyertya-eltávolító készlet
 RO Set extractoare pt. bujii rupte
 FR Kit extracteur bougie de préchauffage
 IT Kit per l'estrazione delle candele rotte
 ES Kit de extractor de bujías incandescentes
 CN 预热塞修理工具

16 PCS **3/8"** 9,5mm **HSS 4241** **CrV**

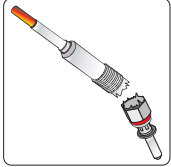

YATO
YT-05342

5

EN Glow plug heater element removal set
 PL Zestaw do demontażu żarnika świec
 DE Set zur Glühfaden-Demontage
 RU Комплект для снятия свечей накаливания
 CZ Souprava pro odstranění vlákná svíc
 HU Gyújtógyertya kiszedő készlet
 RO Extractor element incalzitor bujii
 FR Kit extracteur de filament de bougie
 IT Kit per l'estrazione dei filamenti delle candele
 ES Kit de desmontaje de filamento de vela
 CN 预热塞

22 PCS **HSS**



M8 x 1 mm; M10 x 1 mm; M10 x 1.25 mm

YATO
YT-05345

10

EN Valve grinding set
 PL Zestaw docieraków ręcznych do zaworów
 DE Handventil-Läppsatz
 RU Набор для ручной притирки клапанов
 CZ Sada přípravků pro lapování ventilů
 HU Manuális szelepsciszoló készlet
 RO Set pt. slefuit supape
 FR Kit de rodage soupape
 IT Kit di utensili manuali per lappatura valvole
 ES Conjunto de reguladores manuales de válvulas
 CN 气门研磨棒



2 PCS **15-20** mm **30-36** mm

YATO
YT-06187

40

EN Overhead valve spring compressor
 PL Przyrząd do demontażu zaworów silnikowych
 DE Vorrichtung zur Demontage von Motorventilen
 RU Устройство для демонтажа клапанов двигателя
 CZ Přípravek na demontáž ventilů motoru
 HU Szeleplehúzó készülék
 RO Dispozitiv pt. demontarea supapelor la motoare
 FR Outil pour démonter les soupapes de moteur
 IT Strumento per la rimozione di valvole motore
 ES Instrumento para desmontaje de válvulas de motor
 CN 下压式凡尔钳



EN Overhead valve spring compressor
 PL Przyrząd do demontażu zaworów silnikowych
 DE Vorrichtung zur Demontage von Motorventilen
 RU Устройство для демонтажа клапанов двигателя
 CZ Přípravek na demontáž ventilů motoru
 HU Szeleplehúzó készülék
 RO Dispozitiv pt. demontarea supapelor la motoare
 FR Outil pour démonter les soupapes de moteur
 IT Strumento per la rimozione di valvole motore
 ES Instrumento para desmontaje de válvulas de motor
 CN 气门弹簧压缩器

320 mm **OHV** **FOR ENGINE VALVES DO ZAWORÓW SILNIKOWYCH**

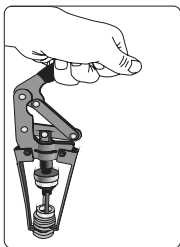

YATO
YT-0618

5/25

YATO
YT-06184

10/20

EN Exhaust pipe expander set
 PL Zestaw rozpiereków do rur wydechowych
 DE Auspuffrohr-Aufweitungs-Satz
 RU Комплект распорок для выхлопных труб
 CZ Sada expanďerů do vřfuků
 HU Kipufogócső tágitó készlet

RO Set largire teava esapament
 FR Kit élargisseur de tuyau d'échappement
 IT Kit di cilindri per tubi di scarico
 ES Kit expansor para tubos de escape
 CN 排气管扩孔器

3 PCS **17** mm **19** mm **29-42** mm **38-62** mm **54-89** mm



YATO
YT-06166

5

EN Exhaust pipe cutting tool
 PL Obcinak do rur wydechowych
 DE Auspuffrohrschneider
 RU Цепной резак выхлопной трубы
 CZ Řezačka vřfukového potrubí
 HU Kipufogócső vágó
 RO Instrument de tăiere a țevilor de esapament
 FR Coupeur de tuyau d'échappement
 IT Tagliatubi di scarico
 ES Cortador de tubos de escape
 CN 排气管割刀

max **2.5**mm STEEL STAL **18-95** mm **x15** **GCr15**



YATO
YT-06169

12/24

EN Oxygen sensor crowfoot wrench
PL Klucz do sondy lambda
DE Schlüssel für die Lambdasonde
RU Ключ для зонда lambda
CZ Klíč na sondu lambda
HU Lambda szonda kulcs
RO Cheie pt. sonda lambda
FR Clé pour sonde lambda

IT Chiave per sonde lambda
ES Llave para la sonda lambda
CN 氧传感器套筒扳手

22 mm FOR OXYGEN SENSOR DO SONDY LAMBDA



CrMo SCM440

CrV 50BV30

YATO	
YT-1753	15/60

YATO	
YT-1754	6/36

EN Socket and oxygen sensor set
PL Klucze nasadowe do sondy lambda
DE Steckschlüssel für Lambdasonde
RU Торцовые ключи с внутренним многогранником для зонда lambda
CZ Nástrčné klíče na sondy lambda
HU Dugókulcs lambda szondához
RO Prize pt. sonda lambda
FR Douille pour sonde lambda
IT Set di riparazione per filetti di sonde lambda
ES Llaves de cubo para la sonda lambda
CN 氧传感器套筒扳手套

3 PCS 22 mm CrMo SCM440
CrV 50BV30 FOR OXYGEN SENSOR DO SONDY LAMBDA

EN Oxygen sensor extra-long socket
PL Klucz do sondy lambda extra dlugi
DE Lambdasonde-Schlüssel extra lang
RU Ключ для lambda-зонда удлиненный
CZ Klíč do lambda sondy extra dlouhý
HU Lambdaszonda kulcs extra hosszú
RO Cheie lunga pt. senzorul de oxigen
FR Clé pour sonde lambda extra longue
IT Chiave extra lunga per sonda lambda
ES Llave para sonda lambda extra larga
CN 加长含氧感应套筒

1/2" 12.7mm 22 mm CrV
FOR OXYGEN SENSOR DO SONDY LAMBDA



22 mm; L=50 mm; 6PT; CrMo SCM440;
22 mm; L=30 mm; 6PT; CrMo SCM440;
22 mm; L=80 mm; 6PT; CrV 50BV30

YATO	
YT-1752	20

YATO		L [mm]	
YT-17513	1/2" (12.7 mm)	150	10/60

EN Oxygen flexi head wrench
PL Klucz łamany do sondy lambda
DE Gelenkschlüssel für Lambdasonde
RU Двусторонний ключ для lambda-зонда
CZ Lámaný klíč do lambda sondy
HU Lambda szonda kulcs
RO Cheie articulata pt. conducte oxigen
FR Clé articulée pour sonde lambda
IT Chiave pieghevole per sonda lambda
ES Llave articulada para la sonda lambda
CN 氧传感扳手



270 mm 22 mm 22 mm CrV FOR OXYGEN SENSOR DO SONDY LAMBDA

YATO	
YT-17515	6/36

EN Oxygen sensor and fuel injectors wrench set
PL Zestaw nasadek do sondy lambda i wtryskiwaczy
DE Steckschlüsselsatz für Lambdasonde und Einspritzdüsen
RU Набор насадок к lambda-зондам и форсункам
CZ Sada nástavců na demontáž sondy lambda a vstříkovačů
HU Dugókészlet lambda szondákhoz és injektorokhoz
RO Set inelare pt. sonda lambda și injectoare
FR Douilles pour sonde lambda et injecteurs
IT Set di attrezzi per sonde lambda e iniettori
ES Juego de boquillas para la sonda lambda y para inyectoros
CN 氧传感器套筒扳手套

7 PCS 1/2" 12.7mm 3/8" 9.5mm
CrMo SCM440 CrV 50BV30 FOR OXYGEN SENSOR DO SONDY LAMBDA FOR FUEL INJECTORS DO WTRYSKIWACZY PALNIKA

EN Oxygen sensor socket & thread chaser set
PL Zestaw do obsługi sondy lambda
DE Wartungssatz für Lambdasonde
RU Набор для обслуживания lambda-зонда
CZ Sada pro práci s lambda sondou
HU Lambdaszonda szerelő szerzőm
RO Set cheie senzor oxigen
FR Kit de douilles pour sonde lambda
IT Strumento per la rimozione della sonda Lambda
ES Juego de vaso para sonda lambda
CN 氧传感器套筒

5 PCS 1/2" 12.7mm 3/8" 9.5mm
M12 x1.25 M18 x1.5 CrMo CrV FOR OXYGEN SENSOR DO SONDY LAMBDA



1/2" (12.7 mm) x 29 mm; L=90 mm; 6PT;
3/8" (9.5 mm) x 22 mm; L=90 mm; 6PT;
1/2" (12.7 mm) x 27 mm; L=78 mm; 12PT;
3/8" (9.5 mm) x 27 mm; L=74 mm; 6PT;
3/8" (9.5 mm) x 22 mm; L=80 mm; 6PT;
1/2" (12.7 mm) x 22 mm; L=50 mm; 6PT;
3/8" (9.5 mm) x 22 mm; L=30 mm; 6PT



22 mm; L=50 mm; 6PT; CrMo;
22 mm; L=30 mm; 6PT; CrMo;
22 mm; L=80 mm; 6PT; CrV

YATO	
YT-1751	1/2" (12.7 mm), 3/8" (9.5 mm) 5

YATO	
YT-17510	1/2" (12.7 mm), 3/8" (9.5 mm) 20

- EN Slotted special socket set
- PL Zestaw nasadek otwartych
- DE Spezial-Steckschlüssel-Einsätze, geschlitz
- RU Набор головок разрезных
- CZ Sada otevřených hlavic
- HU Crowafej speciális végig nyitott
- RO Set de chei tubulare pt. injectoare
- FR Ensemble de clés creuses avec fenêtre latérale
- IT Set di attacchi aperti
- ES Conjunto de teclas huecas con ventana lateral
- CN 开槽油管扳手

7 PCS 3/8" 9.5 mm 1/2" 12.7 mm CrV



10, 11, 12, 13, 14, 17, 19 mm

YATO **YT-17508** 6/24

- EN Flexible crowfoot socket wrench set
- PL Zestaw kluczy przegubowych oczkowych otwartych
- DE Gelenk-Ringschlüssel-Satz (offen)
- RU Набор ключей разрезных с шарниром
- CZ Sada otevřených očkových kloubových klíčů
- HU Nyitott csőkulcs készlet
- RO Set chei tubulare articulate
- FR Set de clés à tête fendue articulée
- IT Set di chiavi snodate ad anello aperte
- ES Juego de llaves articuladas de anillo abiertas
- CN 万向扳手

6 PCS 3/8" 9.5 mm 12-19 mm HRC 43-47 CrV 40Cr



3/8" (9.5 mm): 12, 14, 16, 17, 18, 19 mm; 40Cr/CrV

YATO **YT-01440** 3/8" (9.5 mm) 10

- EN Flexible crowfoot socket wrench set
- PL Zestaw kluczy przegubowych oczkowych otwartych
- DE Gelenk-Ringschlüssel-Satz (offen)
- RU Набор ключей разрезных с шарниром
- CZ Sada otevřených očkových kloubových klíčů
- HU Nyitott csőkulcs készlet
- RO Set chei tubulare articulate
- FR Jeu de clés à tête fendue articulée
- IT Set di chiavi snodate ad anello aperte
- ES Juego de llaves articuladas de anillo abiertas
- CN 万向扳手

12 PCS 3/8" 9.5 mm 8-19 mm HRC 42-48 CrV



3/8" (9.5 mm): 8, 9, 10, 11, 12, 13, 14, 15, 16, 17, 18, 19 mm; CrV

YATO **YT-38550** 3/8" (9.5 mm) 10

- EN Diesel injection socket set
- PL Zestaw nasadek do wtrysków w silnikach Diesla
- DE Aufsätze für Einspritzungen bei Dieselmotoren
- RU Набор насадок к форсункам в дизельных двигателях
- CZ Sada nástavců na trysky dieselových motorů
- HU Szerszámkészlet Dieselmotor befecskendezőkhöz
- RO Set de capete pt. injectoare în motoare Diesel
- FR Set des douilles pour injecteurs (diesel)
- IT Set di custodie per i motori diesel
- ES Juego de tapones para las inyecciones en los motores de Diesel
- CN 柴油机加注套筒组套

6 PCS 1/2" 12.7 mm CrV AS-DRIVE



21x90; 22x78; 22x110; 27x78; 28x78; 28x83 mm

YATO **YT-0622** 1/2" (12.7 mm) 10

- EN Diesel injector and cutter set
- PL Zestaw frezów do gniazd wtryskiwaczy Common Rail
- DE Frärsatz für Buchsen der Einspritzdüsen
- RU Комплект фрез для гнезд сопл форсунок
- CZ Sada fréz na sedla trysek vstřikovačů
- HU Marókészlet befecskendező fűvókájának fészkéhez
- RO Set de freze pt. socluri de duze injectoare
- FR Alimentation d'un injecteur de Common Rail
- IT Set di frese per sedi iniettori Common Rail
- ES Juego de fresas para el asiento de toberas de inyectores
- CN 气门铰刀

7 PCS CrMoV SKD11

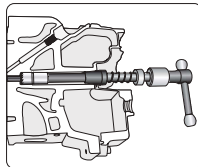

17x17 mm, 17x19 mm, 15x19 mm; CrMoV SKD11; 120° 17x17 mm, 120° 17x21 mm; CrMoV SKD11

YATO **YT-17625** 10

- EN Tooth socket for injection nozzle
- PL Zestaw kluczy czopowych do wtryskiwaczy w samochodach ciężarowych
- DE Stiftschlüsselsatz für Einspritzdüse in Lastkraftwagen
- RU Набор шпильных ключей к форсункам грузовых автомобилей
- CZ Sada klíčů na vstřikovače pro nákladní automobily
- HU Csapókulcs készlet tehergépkocsi befecskendezőjéhez
- RO Set chei tubulare cu ungere pt. camioane
- FR Set de douilles injecteurs
- IT Set di chiavi per iniettori camion
- ES Juego de llaves de muñon para los inyectores en camiones
- CN 卡车喷嘴套筒组套

4 PCS 1/2" 12.7 mm CrMo S45C CrV



1/2" (12.7 mm); L=72 mm; 4T; CrV; 32 mm; M14 x 1.5 mm; L=70 mm; 4T; S45C; 1/2" (12.7 mm); L=120 mm; 3T; CrMo; 32 mm; L=120 mm; 4T; S45C

YATO **YT-1762** 1/2" (12.7 mm) 8

- EN Socket key-attachments for Bosch VE-pumps
PL Zestaw nasadek do pomp wtryskowych Bosch VE
DE Aufsatz-Set für Bosch VE Einspritzpumpen
RU Набор насадок для инжекторных насосов Bosch VE
CZ Sada násad pro vstřikovací čerpadla Bosch VE
HU Dugókulcs Mészlet Bosch VE befecskendőző szivattyúhoz
RO Set tubulare speciale pt. pompe injectie Bosch
FR Jeu de douilles Bosch VE pour pompes d'injection
IT Kit di attacchi per pompe d'iniezione Bosch VE
ES Set de accesorios para bombas de inyección Bosch VE
CN 博世泵套筒

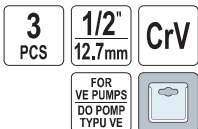

YATO	○	
YT-17525	1/2" (12.7 mm)	12/48

- EN Camshaft adapter socket set
PL Zestaw nasadek do regulacji faz rozrządu
DE Nockenwellen-Adapter-Steckschlüssel-Satz
RU Набор для регулировки распределительного вала
CZ Přípravky na nastavení fázi časování rozvodu
HU Vezérműtengely állítót dugókulcs készlet
RO Set chei adaptoare arbore cu came
FR Jeu d'adaptateurs d'arbre à cames
IT Set di bussolle per sincronizzatore albero a camme
ES Vasos para girar el árbol de levas
CN 凸轮轴接头套筒

Audi: A3 (2011-, 2005-2013), A3 Quattro (2009-2013), A4 (2008, 2009-2015, 2016-), A4 Quattro (2009-2015), A5 (2008-2011), A5 Cabriolet (2009), A5 Coupe (2008), A5 Quattro (2009-2016), A6 2.0 TFSI (2012-2014), Tiguan (2016-), Q3 (2012-2015), Q5 (2008, 2009-2016), TT (2010-2014), TT Quattro (2009-2014); Seat: Alhambra (2011), Altea (2011), Altea XL (2009), Exeo (2009), Freerack (2011), Leon (2011); Skoda: Octavia (2009-2013), Superb (2009-2015), Yeti 1.8 TSI (2010-2015); VW: Beetle 2.0 TSI (2012-2016), CC 1.8 TSI/2.0 TSI (2012-2016), EOS 2.0 TSI (2010-2016), Golf GTI 1.8 TSI/2.0 TSI (2009-2013), Jetta GLI 2.0 TSI (2008-2014), Passat 1.8 TSI/2.0 TSI (2008-2015), Passat CC 1.8 TSI/2.0 TSI (2009-2012), Scirocco 2.0 TSI (2009-2016), Sharan 1.8 TSI/2.0 TSI (2011-2016), Tiguan 2.0 TSI (2008-2016)
Audi: BYT, BZB, CABA, CABB, CABD, CAEA, CAEB, CAED, CBFA, CCTA, CCZA, CCZC, CDDA, CDHA, CDHB, CDNB, CDNC, CESA, CETA, CHJA, CPMA, CPMB, CPSA; Skoda: CCZA; VW: CAWB, CBFA, CCTA, CCZA, CCZB

- EN Fuel injection test kit
PL Zestaw diagnostyczny do wtrysku paliwa
DE Diagnosesatz für Prüfung der Kraftstoffespritzung
RU Пневматический набор к тормозным зажимам
CZ Souprava k diagnostice vstřikování paliva
HU Diagnosztikai készlet üzemanyag - befecskendőzőkhöz
RO Ansamblu pt. diagnosticarea injectiei combustibilului
FR Kit de test de débit d'injecteur
IT Set diagnostico per iniettori la benzina
ES Juego de herramientas diagnosticas para la inyección de combustible
CN 燃料注射测试组套

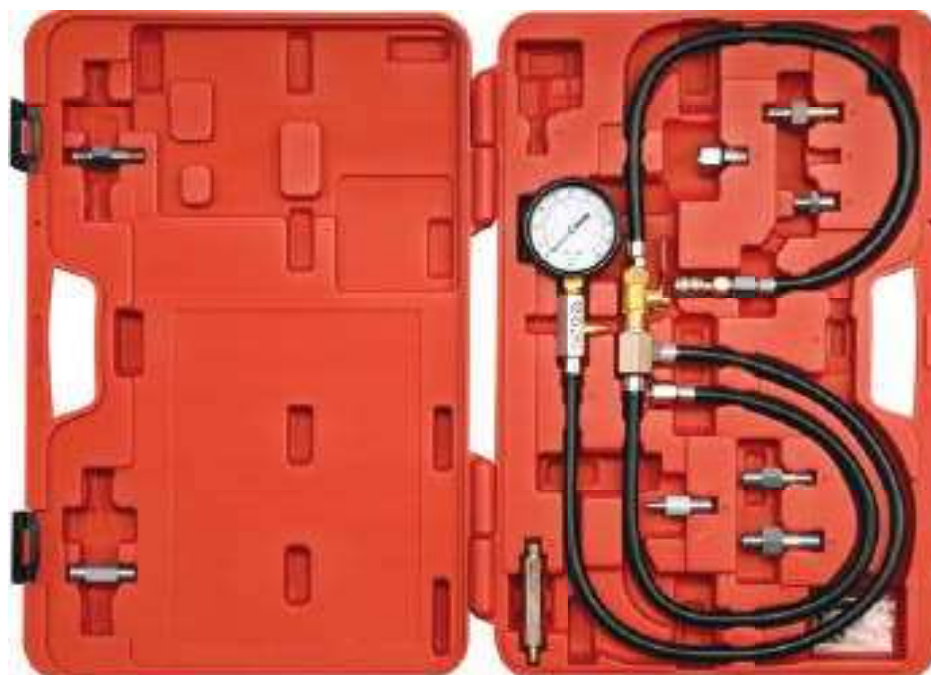

YATO	○	
YT-0670		10

- EN Camshaft joint sleeve
PL Nasadka do regulacji faz rozrządu
DE Aufsatz zur Regelung der Nockenwellenphasenverstellung
RU Насадка для регулировки фаз газораспределения
CZ Nástavec pro regulaci časování ventilů
HU Vezérfésállító dugókulcs
RO Dispozitiv pt. montat manson axa cu came
FR Manchon de déphasage d'arbre à cames
IT Attacco per sincronizzatore albero a camme
ES Vaso para girar el árbol de levas
CN 调节气门正时帽



VAG: Audi: A3 & A3 Sportback (12-16), A3 Cabriolet (13-16), A4 (08-15), A4 Quattro (12-15), A5 (09-11), A5 Sportback (09-16), A5 Cabriolet (09-12), A5 Coupe (13-16), Q5 (05-17), TT (15-18); Seat: Alhambra (11-16), Altea, Altea XL & Altea Freerack (09-16), Exeo (09-16), Leon (09-17), Leon ST (13-17); Skoda: Octavia II (08-13), Octavia III (13-17), Superb II (08-15), Superb III (15-17), Yeti (13-15); VW: Beetle (13-16), CC (12-15), EOS (08-15), Golf V & VI (09-13), Golf VII (12-15), Golf Alltrack (14-17), Jetta VI (11-16), Jetta V (05-11), Passat (11-17), Tiguan (07-15), Touran (14-17)
1.8 TFSI: CDDA, CDAB, CDHA, CDHB, CJEB, CJEE, CJSB, CJEB, 2.0 TFSI: CDNC, CDNE, CDNC, CDNB, CDNC, CFKA, CPSA

YATO	○	
YT-06335	3/8" (9.5 mm)	80



YATO	○	
YT-06336	3/8" (9.5 mm)	20



- EN Fuel pressure tester
- PL Miernik ciśnienia paliwa
- DE Kraftstoffmessgerät
- RU Датчик давления топлива
- CZ Měřič tlaku paliva
- HU Üzemanyagnyomás-mérő
- RO Tester presiune combustibil
- FR Kit de testeur de pression d'injection de carburant
- IT Misuratore della pressione del carburante
- ES Medidor de presión de combustible
- CN 燃油压力表



20 PCS	0-1 MPa	0-140 psi
FOR DIESEL ENGINES DO SILNIKÓW DZIELA	FOR GASOLINE ENGINES DO SILNIKÓW BENZYNOWYCH	

YATO 
YT-73025

6

- EN Compression tester
- PL Miernik ciśnienia sprężania
- DE Druckluftmessgerät
- RU Тестер компрессии
- CZ Měřicí přístroj kompresního tlaku
- HU Kompresszió mérő
- RO Aparat de măsurareea presiunii
- FR Testeur de pression adaptateur cône
- IT Manometro pressione
- ES Medidor de compresión
- CN 气缸压力表



5 PCS	2.1 MPa
M14 M18	FOR SPARK IGNITION DO ZAPLONÓV ISKROVÉGO
RUBBER ADAPTOR ZŁACZEZ GUMOWE	

YATO 
YT-73011

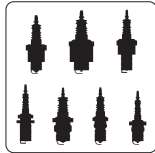

10







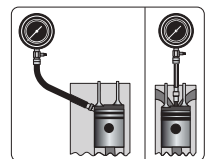

FOR ALL TYPES DO WSZYSTKICH TYPÓW

- EN Compression pressure gauge in a diesel engine
- PL Miernik ciśnienia sprężania w silnikach diesla
- DE Kompressionsdruckmesser in Dieselmotoren
- RU Измеритель давления компрессии в дизельных двигателях
- CZ Souprava k měření kompresních tlaků v dieselových motorech
- HU Dieselmotorok kompresszióját mérő óra
- RO Manometrul presiunii aerului comprimat pt. motoarele diesel
- FR Testeur de pression cylindrique diesel
- IT Tester di compressione per motori diesel
- ES Medidor de presión de la compresión en los motores diesel
- CN 柴油机压力测试组套



16 PCS	7.0 MPa
FOR DIESEL ENGINES DO SILNIKÓW DZIELA	



-  70 bar, 500 mm;
-  160 mm;
-  M20x1.5: 75 mm; M22x1.5: 73 mm; M24x1.5: 88 mm; M24x2: 63 mm;
-  M10x1: 83, 91, 102, 113, 119 mm; M10x1.25: 64, 135 mm; M12x1.25: 47 mm; M22x1.5: 118 mm;
- 

YATO 
YT-7307

5

- EN Compression pressure gauge in a diesel engine
- PL Miernik ciśnienia sprężania w silnikach diesla
- DE Kompressionsdruckmesser in dieselmotoren
- RU Измеритель давления компрессии в дизельных двигателях
- CZ Souprava k měření kompresních tlaků v dieselových motorech
- HU Dieselmotorok kompresszióját mérő óra
- RO Manometrul presiunii aerului comprimat pt. motoarele diesel
- FR Testeur de pression cylindrique diesel
- IT Tester di compressione per motori diesel
- ES Medidor de presión de la compresión en los motores diesel
- CN 柴油机压力测试组套



19 PCS	7.0 MPa
FOR DIESEL ENGINES DO SILNIKÓW DZIELA	

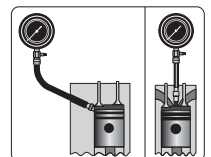

YATO 
YT-73072

10

EN Compression tester
PL Miernik ciśnienia sprężania
DE Druckluftmessgerät
RU Тестер компрессии
CZ Měřicí přístroj kompresního tlaku
HU Kompresszió mérő
RO Aparat de măsurareea presiunii
FR Testeur de pression adapteur cône
IT Manometro pressione
ES Medidor de compresión
CN 气缸压力表



50
PCS

4.0
MPa

FOR DIESEL ENGINES DO SILNIKÓW DZIELA

FOR GASOLINE ENGINES DO SILNIKÓW BENZYNOWYCH

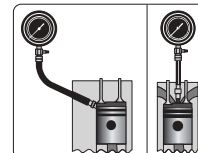
YATO 
YT-73012

4

EN Engine and transmission oil pressure test kit
PL Zestaw mierników ciśnienia oleju silnika i skrzyni biegów
DE Motor- und Öldruck-Test-Set
RU Набор для измерения давления масла в двигателе и АКПП
CZ Sada pro měření tlaku motorového a převodového oleje
HU Motor-és sebességváltó olajnyomás mérő készlet
RO Kit de testare a presiunii uleiului de motor și transmisie
FR Kit de test de pression d'huile dans le moteur et la boîte de vitesses
IT Kit di misuratori di pressione dell'olio nel motore e nel cambio
ES Juego de manómetros presión de aceite en motor y caja
CN 机油高低压测试工具



17
PCS

0-2.75
MPa

0-400
psi

0-0.7
MPa

0-100
psi

1.85m
cm

FOR DIESEL ENGINES DO SILNIKÓW DZIELA

FOR GASOLINE ENGINES DO SILNIKÓW BENZYNOWYCH



Included: pressure gauges: 0-400 PSI, 0-100 PSI (2 PCS); flexible hose 185 cm; adaptors (14 PCS): 1/8-27 NPT x 2, 3/8-18 NPT (M) x 1/8-27 (F), 1/4-18 NPT (M) x 1/8-27 NPT (F), 1/4-18 NPT (M) x 1/8-27 NPT (M), 1/8-27 NPT (F), 1/8-27 NPT (M) x 1/8-27 NPT (F, elbow), M8 x 1.0 x 1/8-27 NPT (F), M10 x 1.0 x 1/8-27 NPT (F), M12 x 1.75 x 1/8-27 NPT (F), 1/8-28 BSPT x 1/8-27 NPT (F), 1/16-27 NPT (M) x 1/8-27 NPT (F)
W zestawie: manometry: 0-400 PSI, 0-100 PSI (2 szt.); elastyczny wąż 185 cm; adaptery (14 szt.): 1/8-27 NPT x 2, 3/8-18 NPT (M) x 1/8-27 (F), 1/4-18 NPT (M) x 1/8-27 NPT (F), 1/4-18 NPT (M) x 1/8-27 NPT (M), 1/8-27 NPT (F), 1/8-27 NPT (M) x 1/8-27 NPT (F, kątowny), M8 x 1.0 x 1/8-27 NPT (F), M10 x 1.0 x 1/8-27 NPT (F), M12 x 1.75 x 1/8-27 NPT (F), 1/8-28 BSPT x 1/8-27 NPT (F), 1/16-27 NPT (M) x 1/8-27 NPT (F)

YATO 
YT-73032

10

EN Compression tester kit
PL Miernik ciśnienia sprężania - benzyna
DE Kompressionsmessgerät - Ottomotoren
RU Измеритель давления сжатия - бензин
CZ Kompresní tlakoměr - benzín
HU Benzin kompresszió mérő
RO Kit tester compresie
FR Manomètre de compression pour moteur à essence
IT Tester di compressione per motori a benzina
ES Medidor de presión de compresión, gasolina
CN 汽油压力表



8
PCS

0-2
MPa

0-300
psi

FOR GASOLINE ENGINES DO SILNIKÓW BENZYNOWYCH



YATO 
YT-73022

6

EN Oil combustion spraying pressure meter
PL Miernik ciśnienia wtrysku paliwa
DE Kraftstoff-Einspritzdruckmessgerät
RU Измеритель давления впрыска топлива
CZ Měřič tlaku vstřikování paliva
HU Üzemanyag befecskendező nyomásmérő
RO Kit măsurare presiune injectoare
FR Manomètre de pression d'injection du carburant
IT Misuratore della pressione di iniezione del carburante
ES Medidor de presión de inyección de combustible
CN 燃油喷射压力表



9
PCS

0-0.7
MPa

0-100
psi



YATO 
YT-73024

10

- EN Oil combustion spraying pressure meter
- PL Miernik ciśnienia wtrysku paliwa
- DE Kraftstoff-Einspritzdruckmessgerät
- RU Измеритель давления впрыска топлива
- CZ Měřič tlaku vstřikování paliva
- HU Üzemanyag befecskendező nyomásmérő
- RO Kit masurare presiune injectoare
- FR Manomètre de pression d'injection du carburant
- IT Misuratore della pressione di iniezione del carburante
- ES Medidor de presión de inyección de combustible
- CN 燃油喷射压力表



10 PCS **0-0.7** MPa **0-100** psi 

YATO  **YT-73023**  10

- EN Vacuum & fuel pump tester
- PL Wakuometr - miernik pomiaru ciśnienia i podciśnienia
- DE Vakuummessgerät - Druck- und Unterdruckmessgerät
- RU Вакуумметр - прибор для измерения давления и вакуума
- CZ Vakuové měřidlo - zařízení pro měření tlaku a podtlaku
- HU Nyomásmérő és vákuummérő
- RO Tester pompa combustibil
- FR Vacuomètre - manomètre de mesure de pression et de dépression
- IT Vacuometro - misuratore della pressione-depressione
- ES Vacuómetro: medidor de presión y presión negativa
- CN 真空压力表





9 PCS **0-0.1** MPa **0-14** psi 

YATO  **YT-73050**  10

- EN Oil pressure tester
- PL Miernik ciśnienia oleju
- DE Öldruckanzeige
- RU Тестер давления масла с адаптерами
- CZ Tester tlaku oleje
- HU Olajnyomásmérő készlet
- RO Tester presiune ulei
- FR Set de testeurs de pression d'huile
- IT Tester misurazione pressione dell'olio
- ES Manómetro de aceite
- CN 自动波箱压力表



12 PCS **3.5** MPa **185cm** 
FOR ALL TYPES OF ENGINES DO WSZYSTKICH TYPOW SILNIKOW 

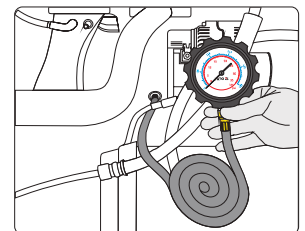

YATO  **YT-73030**  10

- EN Oil pressure tester
- PL Miernik ciśnienia oleju
- DE Öldruckanzeige
- RU Тестер давления масла с адаптерами
- CZ Tester tlaku oleje
- HU Olajnyomásmérő készlet
- RO Tester presiune ulei
- FR Set de testeurs de pression d'huile
- IT Tester misurazione pressione dell'olio
- ES Manómetro de aceite
- CN 油压压力表



12 PCS **0-1** MPa **0-140** psi **125cm** 
FOR ALL TYPES OF ENGINES DO WSZYSTKICH TYPOW SILNIKOW 

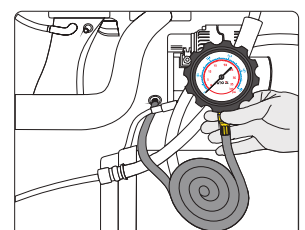



YATO  **YT-73031**  10

Adapters / adaptory: R1/8 DIN 2999; 1/8" 27 NPT; 1/4" 18 NPT; 3/8" 20 UNF; 1/2" 20 UNF; M10 x 1.0; M12 x 1.5; M14 x 1.5; M16 x 1.5; M18 x 1.5

- EN Cylinder leak detector
- PL Zestaw do pomiaru szczelności cylindrów
- DE Zylinder-Druckverlust-Tester
- RU Набор для измерения герметичности цилиндра
- CZ Sada pro měření těsnosti válců
- HU Kompresszióvégnomás-mérő készlet
- RO Dispozitiv detectare pierdere presiune cilindrii
- FR Ensemble de mesure d'étanchéité des vérins
- IT Kit per la misura di tenuta cilindri
- ES Kit para medir fugas de cilindros
- CN 汽缸测漏表



4 PCS	0.7 MPa	FOR GASOLINE ENGINES DO SILNIKÓW BENZYNOWYCH
		

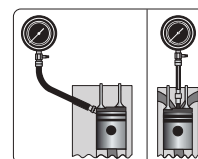



YATO 
YT-73055

5

- EN Common cool gas meter
- PL Zestaw do obsługi systemów klimatyzacji
- DE Bedienungssatz für Klimasysteme
- RU Комплект для эксплуатации систем кондиционирования
- CZ Sada pro obsluhu klimatizačních systémů
- HU Klíma szivárgáskereső készlet
- RO Manometru pt. gaz
- FR Ensemble pour la maintenance des systèmes de climatisation
- IT Kit manutenzione per impianto aria condizionata
- ES Kit de operación de sistemas de aire acondicionado
- CN 冷媒表





6 PCS	0-0.8 MPa	0-3.4 MPa
	R-134a	

YATO 
YT-72990

6

- EN Ozone generator
- PL Generator ozonu
- DE Ozon-Generator
- RU Генератор озона
- CZ Generátor ozónu
- HU Ózongenerátor
- RO Generator ozon
- FR Générateur d'ozone
- IT Generatore di ozono
- ES Generador de ozono
- CN 臭氧机



110-230V~50/60Hz	220 W	10 g/h
	0-90 min	

YATO 
YT-73350

[W]

220



4

- EN Compression tester
- PL Miernik ciśnienia sprężania
- DE Druckluftmessgerät
- RU Тестер компрессии
- CZ Měřicí přístroj kompresního tlaku
- HU Kompresszió mérő
- RO Aparat de măsurareea presiunii
- FR Testeur de pression adapteur cône
- IT Manometro pressione
- ES Medidor de compresión
- CN 汽缸压力表

2.1 MPa	FOR SPARK IGNITION DO ZAPALÓNÍ SKRŮVĚHOVO	RUBBER CONNECTOR ZLĄCZE GUMOWE	
-------------------	---	--------------------------------	---

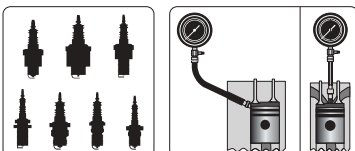

FOR ALL TYPES DO WSZYSTKICH TYPÓW



YATO 
YT-7300



24/48

- EN Compression tester
- PL Miernik ciśnienia sprężania
- DE Druckluftmessgerät
- RU Тестер компрессии
- CZ Měřicí přístroj kompresního tlaku
- HU Kompresszió mérő
- RO Aparat de măsurareea presiunii
- FR Testeur de pression adapteur cône
- IT Manometro pressione
- ES Medidor de compresión
- CN 汽缸压力表

2.1 MPa	FOR SPARK IGNITION DO ZAPALÓNÍ SKRŮVĚHOVO	THREADED ADAPTER ZŁĄCZE GWINTOWANE	
-------------------	---	------------------------------------	---

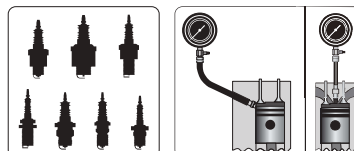

FOR ALL TYPES DO WSZYSTKICH TYPÓW



YATO 
YT-7301

12/24

EN Compression tester
 PL Miernik ciśnienia sprężania
 DE Druckluftmessgerät
 RU Тестер компрессии
 CZ Měřicí přístroj kompresního tlaku
 HU Kompresszió mérő
 RO Aparat de măsurareea presiunii
 FR Testeur de pression adapteur cône
 IT Manometro pressione
 ES Medidor de compresión
 CN 气缸压力表组套



FOR ALL TYPES
 DO WSZYSTKICH TYPOW

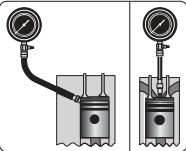

2.1
MPa

FOR SPARK
 IGNITION
 DO ZAPŁONU
 ISKROWEGO

THREADED
 ADAPTER
 ZŁĄCZE
 GWINTOWANE

RUBBER
 CONNECTOR
 ZŁĄCZE
 GUMOWE



60
MPa
(max.)

600
ml

M12

M14

FOR DIESEL
 ENGINES
 DO SILNIKÓW
 DIELA



EN Injetion nozzle tester
 PL Tester wtryskiwaczy
 DE Einspritz-Tester
 RU Тестер форсунок
 CZ Tester vstřikovačů
 HU Portaszító vizsgáló tesztler
 RO Tester de duze de injecție
 FR Testeur d'injecteur de carburant
 IT Tester per iniettori
 ES Comprobador de inyectoros
 CN 喷油嘴校检器



YATO
 YT-7302

6/24

YATO
 YT-72963

4

EN Flow meter common rail adapter set
 PL Przelewowy zestaw diagnostyczny do wtryskiwaczy Common Rail
 DE Überlauf-Diagnosesatz für Einspritzdüse Common Rail
 RU Диагностический набор к форсунам Common Rail переливной
 CZ Souprava na diagnostiku vstřikovačů Common Rail průtoková
 HU Diagnosztkai készlet Common Rail injektorokhoz, átfolyós
 RO Set diagnostic preaplin pt. injectoare Common Rail
 FR Kit de test de débit d'injecteur Common Rail
 IT Set controllo portata iniettori Common Rail
 ES Juego diagnóstico de flujo para inyectoros Common Rail
 CN 柴油燃油喷油嘴检测工具



31
PCS

FOR 6
 CYLINDERS
 DO 6
 CYLINDROV

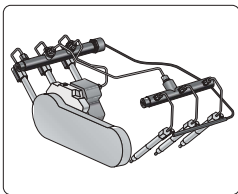

YATO
 YT-7306

5

EN Diesel fuel pump timing set
 PL Prząd do regulacji pomp wtryskowych
 DE Vorrichtung zur Einspritzpumpeneinstellung
 RU Инструмент для регулировки ТНВД
 CZ Nástroj pro regulaci vstřikovací čerpadel
 HU Befecskenedző szivattyú beállító szerszám
 RO Set de distribuție a pompei de combustibil diesel
 FR Outil de réglage des pompes d'injection
 IT Strumento di regolazione pompa di iniezione
 ES Herramienta de ajuste de bombas de inyección
 CN 柴油喷射泵校正器



10
PCS

+/-
0.01
mm



YATO
 YT-05337

5

For fuel pump: Bosch, Denso, Lukas, Nippon
 Dla pomp: Bosch, Denso, Lukas, Nippon

EN Combined sockets for alternator
PL Zestaw do alternatorów ze sprzęgłem
DE Werkzeugsatz für Lichtmaschine
RU Набор для альтернатора
CZ Souprava na opravu alternátorů
HU Generátor szerszámkészlet
RO Garnitură pt. alternator
FR Set de clés à l'alternateur avec l'embrayage
IT Set di chiavi per smontaggio puleggia e alternatore
ES Enchufes combinados para alternador
CN 发动机拆卸组套



- □ □ □ □ 1/2" (12.7 mm); M10, HBS, 33T, L=110 mm; CrV; HRC 40-44;
- □ □ □ □ 1/2" (12.7 mm); T50, HBS, 33T, L=110 mm; CrV; HRC 40-44;
- □ □ □ □ M8, M10, L=75 mm; 8660; HRC 53-57;
- □ □ □ □ T40, T50, L=75 mm; 8660; HRC 53-57;
- □ □ □ □ H8, H10, L=75 mm; 8660; HRC 53-57;
- □ □ □ □ H15, 33T, L=30 mm; CrV; HRC 40-44;
- □ □ □ □ H22, 33T, L=30 mm; CrV; HRC 40-44;
- □ □ □ □ H22, L=30 mm; S45C; HRC 38-42;
- □ □ □ □ Ø 35 x 30 mm; CrV; HRC 40-44;
- □ □ □ □ 1/2" (12.7 mm) x 10 mm; CrV; HRC 40-44



YATO	○	
YT-0421	1/2" (12.7 mm)	15

EN Combined sockets for alternator
PL Zestaw do alternatorów ze sprzęgłem
DE Werkzeugsatz für Lichtmaschine
RU Набор для альтернатора
CZ Souprava na opravu alternátorů
HU Generátor szerszámkészlet
RO Garnitură pt. alternator
FR Set de clés à l'alternateur avec l'embrayage
IT Set di chiavi per smontaggio puleggia e alternatore
ES Enchufes combinados para alternador
CN 发动机拆卸组套

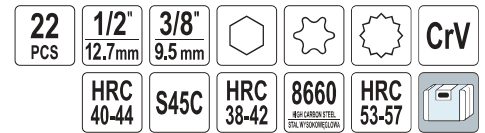

- □ □ □ □ 1/2" (12.7 mm); M10, HBS, 33T, L=113 mm; CrV; HRC 40-44 / 8660; HRC 53-57;
- □ □ □ □ 1/2" (12.7 mm); T50, HBS, 33T, L=113 mm; CrV; HRC 40-44 / 8660; HRC 53-57;
- □ □ □ □ 3/8" (10 mm); M10; HBS, 33T; L=80 mm; CrV; HRC 40-44 / 8660; HRC 53-57;
- □ □ □ □ 1/2" (12.5 mm); M10; HBS, 33T; L=140 mm; CrV; HRC 40-44;
- □ □ □ □ M8, M10, L=75 mm; 8660; HRC 53-57;
- □ □ □ □ T40, T50, L=75 mm; 8660; HRC 53-57;
- □ □ □ □ H8, H10, L=75 mm; 8660; HRC 53-57;
- □ □ □ □ M8xH12, L=64 mm; 8660; HRC 53-57;
- □ □ □ □ H15, 33T, Ø 17 mm, L=30 mm, H15, 33T, Ø 19 mm, L=30 mm, H22, 33T, Ø 19 mm, L=30 mm; CrV; HRC 40-44;
- □ □ □ □ H17, H22, L=30 mm; S45C; HRC 38-42;
- □ □ □ □ Ø 35 x 30 mm; S45C; HRC 38-42;
- □ □ □ □ Ø 38 mm; S45C; HRC 38-42;
- □ □ □ □ H19x28, H21x28, H22x28; S45C; HRC 38-42;
- □ □ □ □ 1/2" (12.5 mm) (F) x H10 mm (F); CrV; HRC 40-44



YATO	○	
YT-04211	3/8" (9.5 mm), 1/2" (12.7 mm)	5

EN Stroboscopic tube
PL Lampa stroboskopowa
DE Stroboskoplampe
RU Стробоскопная лампа
CZ Stroboskopická lampa
HU Stroboszkóp lámpa

RO Lampă stroboscopică
FR Lampe stroboscopique
IT Lampada stroboscopica
ES Tubo estroboscópico
CN 点火正时灯

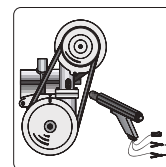

0-60°

YATO		
YT-7310		6/12

YATO		
YT-7311		6/12

YATO		
YT-7312		6/12

EN Universal radiator pressure kit
 PL Zestaw diagnostyczny do chłodnicy
 DE Diagnosekit für Kühler
 RU Диагностический набор к радиатору
 CZ Souprava k diagnostice chladiče
 HU Diagnosztikai készlet hűtőkhöz
 RO Ansamblu pt. diagnosticarea radiatorului
 FR Set diagnostique pour radiateur de voiture
 IT Set universale tester pressione del radiatore
 ES Juego de herramientas diagnosticas para el radiador
 CN 万用水箱压力测试组套

14
PCS

0.25
MPa
(max.)

max °C
200

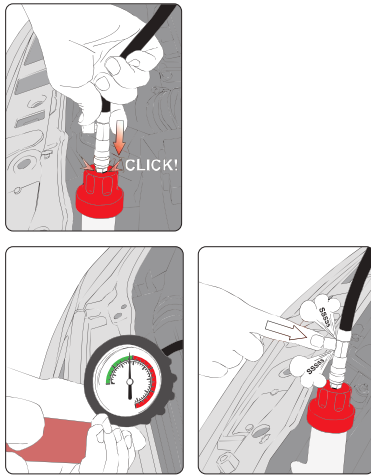

Acura, Alfa Romeo, Audi, BMW, Chrysler, Citroen, Fiat, Ford, General Motors, GEO, Honda, Infiniti, Isuzu, Jaguar, Jeep, Land Rover, Mazda, Mercedes, Mitsubishi, Nissan, Opel, Peugeot, Porsche, Renault, Saab, Subaru, Suzuki, Toyota, Volkswagen, Volvo

YATO
YT-0672

4

EN Cooling system vacuum purge and refill kit
 PL Zestaw do próżniowego napełniania układu chłodzenia
 DE Kühlsystem Vakuum Entleer- und Befüll-Set
 RU Комплект для вакуумной заправки системы охлаждения
 CZ Sada pro vakuové plnění chladičoho systému
 HU Vákuumos hűtőrendszer feltöltő
 RO Kit încărcare și aerisire în vid pt. sistem răcire
 FR Kit d'outils de remplissage sous vide de liquide de refroidissement
 IT Kit di riempimento del sistema di raffreddamento sottovuoto
 ES Kit de llenado al vacío del sistema de refrigeración
 CN 防冻液加注器

3
PCS

-1
bar

\varnothing 15-45 mm

EN Water tank leak detector
 PL Zestaw do diagnostyki i obsługi układu chłodzenia
 DE Diagnose- und Wartungssatz für Kühlkreis
 RU Комплект для диагностики и обслуживания системы охлаждения
 CZ Sada pro diagnostiku a servis chladičoho systému
 HU Hűtőrendszer diagnosztikai és szerviz készlet
 RO Detector scurgeri rezervor apa
 FR Kit de diagnostic de système de refroidissement
 IT Kit di diagnostica e utilizzo del sistema di raffreddamento
 ES Kit de diagnóstico y manejo del sistema de refrigeración
 CN 水箱测漏仪

28
PCS

0.25
MPa
(max.)



YATO
YT-72995

10



Acura; Alfa Romeo; Audi: A4, A5, A6; Audi VW (1975-1993); BMW: 345, E32, E34, E36, E38, E39, E46, E60, E63, E64, E65, E90; Buick; Cadillac; Chevrolet; Citroen; Chrysler; Daewoo; Dodge; Eagle; Fiat; Ford: C-Max, Focus, Mondeo, USA versions etc.; General Motors; GMC; Honda; Hummer; Hyundai; Infiniti; International; Isuzu; Jaguar; Jeep; Kia; Land Rover; Lexus; Lincoln; Mazda: M3 etc.; Mercedes-Benz: A, C, E, M, S Class (W140, W168, W210, W211, W215, W216, W220, R230), W123, W126, W124, W201, Vito; Mercury; Mini; Mini Cooper; Mitsubishi; Nissan; Oldsmobile; Opel; Peugeot; Pontiac; Porsche: Cayenne etc.; Renault; Saab; Saturn; Ssangyong; Sterling; Subaru; Suzuki; Toyota: Celica, MR2, Previa, RAV4 etc.; Vauxhall; Volvo; VW: Beetle, Golf, Passat (1996, 1997-2002), Sharan (1.8T, 2.8), T4, Vento

YATO
YT-06721

3

- EN Cooling system vacuum purge and refill kit
PL Zestaw do próżniowego napelniania układu chłodzenia
DE Kühlsystem Vakuum Entleer- und Befüll-Set
RU Комплект для вакуумной заправки системы охлаждения
CZ Sada pro vakuové plnění chladicího systému
HU Vákuumos hűtőrendszer feltöltő
RO Kit încărcare și aerisire în vid pt. sistem răcire
FR Kit d'outils de remplissage sous vide de liquide de refroidissement
IT Kit di riempimento del sistema di raffreddamento sottovuoto
ES Kit de llenado al vacío del sistema de refrigeración
CN 防冻液加注器



6
PCS

-1
bar

∅
30-48
mm



YATO 

YT-72996



10

- EN Water pump tester
PL Tester pompy wodnej i układu chłodzenia
DE Wasserpumpen- und Kühlsystemtester
RU Тестер водяного насоса системы охлаждения
CZ Tester vodního čerpadla chladicího systému
HU Vízpumpa-vizsgáló készlet
RO Tester pompa de apa
FR Testeur de pompe à eau et système de refroidissement
IT Tester della pompa dell'acqua nel sistema di raffreddamento
ES Probador para bombas de agua y circuito de refrigeración
CN 水泵测试工具



8
PCS

0-0.1
MPa

0-15
psi



YATO 

YT-73065



10

- EN Hand-held vacuum pump
PL Pompka podciśnieniowa z akcesoriami
DE Unterdruckpumpe mit Zubehör
RU Насос вакуумметрического давления с принадлежностями
CZ Podtlaková-tlaková pumpa s příslušenstvím
HU Vákuum- és ac-pumpa mérő, tartozékokkal
RO Pompa de vidare cu accesorii
FR Pompe à vide avec les accessoires
IT Pompa a pressione con accessori
ES Bomba de subpresión con accesorios
CN 手持式真空泵

16
PCS

-1-0
bar



- EN Hand-held vacuum pump
PL Pompka ciśnieniowo-podciśnieniowa z akcesoriami
DE Unterdruck-druckpumpe mit Zubehör
RU Насос вакуумметрического давления с принадлежностями
CZ Podtlaková-tlaková pumpa s příslušenstvím
HU Vákuum- és ac-pumpa mérő, tartozékokkal
RO Pompa de vidare cu accesorii
FR Pompe à vide avec les accessoires
IT Pompa a pressione con accessori
ES Bomba de subpresión-presión con accesorios
CN 手持式真空泵

22
PCS

-1-3
bar



YATO 
YT-0673



10



YATO 
YT-0674



5

EN Flexible line clamp
 PL Komplet zacisków do przewodów z cieczą
 DE Schlauchklemmensatz
 RU Набор зажимов с фиксатором
 CZ Sada hadicových svěrek
 HU Flexibilis cső elszorító készlet
 RO Clema flexibilă
 FR Set de pices pour serrer les
 IT Set pinze per chiudere momentaneamente i manicotti
 ES Juego de alicates apretadores para conductos de líquidos
 CN 油管封口钳组套

3 PCS
 NON-CUTTING
 NIETNACE
 NON-CONDUCTIVE
 NIEPRZEWODZĄCE



- 1/4"-3/4" (6.3-19 mm) for brake and fuel lines
- 1/2"-5/4" (12.5-32 mm) for flexible hose
- 3/4"-9/4" (19-57 mm) for radiator hose clamp
- 1/4"-3/4" (6.3-19 mm) do przewodów hamulcowych i paliwowych
- 1/2"-5/4" (12.5-32 mm) do przewodów elastycznych
- 3/4"-9/4" (19-57 mm) do przewodu chłodnicy

YATO **YT-0840** 25/50

EN Flexible line clamp
 PL Komplet zacisków do przewodów z cieczą
 DE Schlauchklemmensatz
 RU Набор зажимов с фиксатором
 CZ Sada hadicových svěrek
 HU Flexibilis cső elszorító készlet
 RO Clema flexibilă
 FR Set de pices pour serrer les
 IT Set pinze per chiudere momentaneamente i manicotti
 ES Juego de alicates apretadores para conductos de líquidos
 CN 油管夹

3 PCS
 NON-CUTTING
 NIETNACE
 BENT
 WYGIĘTE
 NON-CONDUCTIVE
 NIEPRZEWODZĄCE

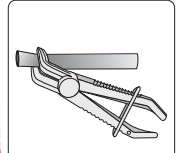

- Max. 13 mm - for brake and fuel lines
- Max. 17 mm - for flexible hose
- Max. 32 mm - for radiator hose clamp
- Max. 13 mm - do przewodów hamulcowych i paliwowych
- Max. 17 mm - do przewodów elastycznych
- Max. 32 mm - do przewodu chłodnicy

YATO **YT-08403** 5/15

EN Steel line clamp
 PL Zaciski do przewodów metalowych
 DE Klemmen für Leitungen aus Metall
 RU Клеммы для металлических проводов
 CZ Svorky pro kovové vodiče
 HU Csipesz fém vezetékhez
 RO Set pt. blocare conducte de combustibil si conducte de frane
 FR Pince d'arrêt de conduites métalliques
 IT Morsetti per conduttori metallici
 ES Abrazaderas para conductos de metal
 CN 油管夹

4 PCS
 NYLON
 FOR STEEL LINES
 DO PRZEWODÓW METALOWYCH



YATO **YT-08390** 10/20

EN Steel line clamp
 PL Zaciski do przewodów metalowych
 DE Klemmen für Leitungen aus Metall
 RU Клеммы для металлических проводов
 CZ Svorky pro kovové vodiče
 HU Csipesz fém vezetékhez
 RO Set pt. blocare conducte de combustibil si conducte de frane
 FR Pince d'arrêt de conduites métalliques
 IT Morsetti per conduttori metallici
 ES Abrazaderas para conductos de metal
 CN 油管夹

8 PCS
 NYLON
 FOR STEEL LINES
 DO PRZEWODÓW METALOWYCH



YATO **YT-08391** 10

EN Fuel line clamp and stopper kit
 PL Zestaw zacisków do przewodów metalowych i elastycznych
 DE Satz von Klemmen für flexible Leitungen und Leitungen aus Metall
 RU Набор клемм для металлических и гибких проводов
 CZ Sada svorek pro kovové a elastické vodiče
 HU Csipeszkészlet fém és rugalmas vezetékhez
 RO Cleme pt. conducte combustibil si kit opritor
 FR Ensemble de pince d'arrêt de conduites métalliques et en plastique
 IT Morsettiera per conduttori metallici elastici
 ES Juego de abrazaderas para conductos de metal y flexibles
 CN 燃油管夹



12 PCS
 NYLON
 FOR STEEL AND COPPER LINES
 DO PRZEWODÓW METALOWYCH I ELASTYCZNYCH

YATO **YT-08392** 5

EN Spark plug socket
PL Nasadka do świec
DE Steckschlüssel mit Gummihalterung
RU Головка свечная
CZ Nastavec pro svíčky
HU Gyújtógyertya toldalék
RO Cheie de bujii
FR Douille à bougies
IT Chiave a bussola per candele
ES Boquilla de bujías
CN 火花塞套筒

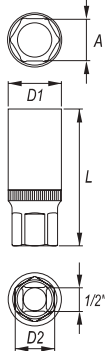

EN Spark plug socket
PL Nasadka do świec
DE Steckschlüssel mit Gummihalterung
RU Головка свечная
CZ Nastavec pro svíčky
HU Gyújtógyertya toldalék
RO Cheie de bujii
FR Douille à bougies
IT Chiave a bussola per candele
ES Boquilla de bujías
CN 火花塞套筒

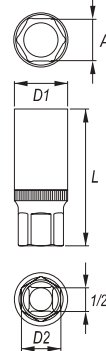

YATO	Ø	A [mm]	D1 [mm]	D2 [mm]	L [mm]	PCS	PCB
YT-1253	1/2" (12.7 mm)	16	22	19	64	10	50/100
YT-1254	1/2" (12.7 mm)	21	27.8	24	64	10	50/100

YATO	Ø	A [mm]	D1 [mm]	D2 [mm]	L [mm]	PCS	PCB
YT-12531	1/2" (12.7 mm)	16	22.0	19	64	10	10/160
YT-12541	1/2" (12.7 mm)	21	27.8	24	64	10	10/120

EN Spark plug socket
PL Nasadka do świec
DE Steckschlüssel mit Gummihalterung
RU Головка свечная
CZ Nastavec pro svíčky
HU Gyújtógyertya toldalék
RO Cheie de bujii
FR Douille à bougies
IT Chiave a bussola per candele
ES Boquilla de bujías
CN 六角火花塞套筒

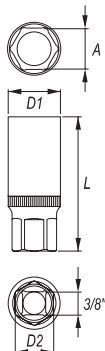

EN Spark plug socket
PL Nasadka do świec
DE Steckschlüssel mit Gummihalterung
RU Головка свечная
CZ Nastavec pro svíčky
HU Gyújtógyertya toldalék
RO Cheie de bujii
FR Douille à bougies
IT Chiave a bussola per candele
ES Boquilla de bujías
CN 六角火花塞套筒

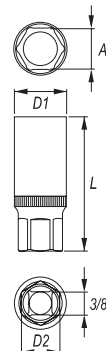

YATO	Ø	A [mm]	D1 [mm]	D2 [mm]	L [mm]	PCS	PCB
YT-3851	3/8" (9.5 mm)	16	22	19	64	10	50/100

YATO	Ø	A [mm]	D1 [mm]	D2 [mm]	L [mm]	PCS	PCB
YT-3841	3/8" (9.5 mm)	18	25.8	19	63	10	50/100

EN Spark plug socket
PL Nasadka do świec
DE Steckschlüssel mit Gummihalterung
RU Головка свечная
CZ Nastavec pro svíčky
HU Gyújtógyertya toldalék
RO Cheie de bujii
FR Douille à bougies
IT Chiave a bussola per candele
ES Boquilla de bujías
CN 磁性十二角薄壁火花塞套筒

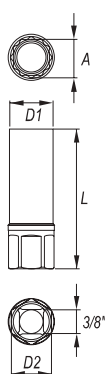

EN Spark plug socket
PL Nasadka do świec
DE Steckschlüssel mit Gummihalterung
RU Головка свечная
CZ Nastavec pro svíčky
HU Gyújtógyertya toldalék
RO Cheie de bujii
FR Douille à bougies
IT Chiave a bussola per candele
ES Boquilla de bujías
CN 磁性十二角薄壁火花塞套筒

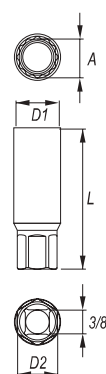

YATO	Ø	A [mm]	D1 [mm]	D2 [mm]	L [mm]	PCS	PCB
YT-38510	3/8" (9.5 mm)	14	18	16	63	25	100

YATO	Ø	A [mm]	D1 [mm]	D2 [mm]	L [mm]	PCS	PCB
YT-38511	3/8" (9.5 mm)	16	20	16	62	25	100

EN Spark plug socket
 PL Nasadka do świec
 DE Steckschlüssel mit Gummihalterung
 RU Головка свечная
 CZ Nastavec pro svíčky
 HU Gyújtógyertyya toldalék
 RO Cheie de buji
 FR Douille à bougies
 IT Chiave a bussola per candele
 ES Boquilla de bujías
 CN 磁性万向十二角火花塞套筒

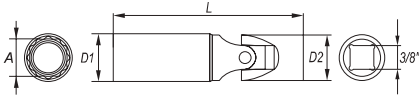

YATO	Ø	A [mm]	D1 [mm]	D2 [mm]	L [mm]	
YT-38512	3/8" (9.5 mm)	14	20	19	88	25/100

EN Spark plug socket
 PL Nasadka do świec
 DE Steckschlüssel mit Gummihalterung
 RU Головка свечная
 CZ Nastavec pro svíčky
 HU Gyújtógyertyya toldalék
 RO Cheie de buji
 FR Douille à bougies
 IT Chiave a bussola per candele
 ES Boquilla de bujías
 CN 火花塞套筒

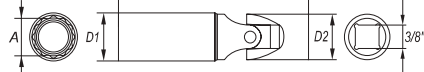
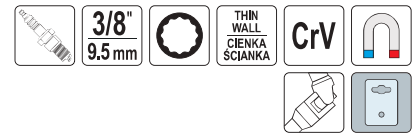

YATO	Ø	A [mm]	D1 [mm]	D2 [mm]	L [mm]	
YT-38516	3/8" (9.5 mm)	14	19	19	98	25/100
YT-38517	3/8" (9.5 mm)	16	20	19	98	25/100

EN Spark plug socket
 PL Klucz do świec z przedłużką
 DE Kerzenschlüssel mit Verlängerungshebel
 RU Ключ к свечам с удлинителем
 CZ Klíč na svíčky s prodlužovacím nástavcem
 HU Gyertyakulcs hosszabbítóval
 RO Cheie cu prelungitor, pt. buji
 FR Douille à bougies
 IT Chiavi per candele a tubo
 ES Llave para las bujías con extensión
 CN 加长带磁万向火星



YATO	A [mm]	L [mm]	
YT-0817	16	290	10/40

EN Extra long spark plug socket
 PL Nasadka do świec extra długa
 DE Zündkerzensteckschlüssel, extra lang
 RU Удлиненная насадка для свечи
 CZ Násada do svíčky extra dlouhá
 HU Gyertyakulcs extra hosszú
 RO Cheie buji lunga
 FR Douille pour bougie d'allumage extra longue
 IT Chiave a bussola per candele extra lungo
 ES Vaso para bujías extra largo
 CN 十二角加长火花塞磁钢款



YATO	A [mm]	
YT-38521	14	12/48
YT-38522	16	12/48

EN Spark plug socket
 PL Klucz do świec z przedłużką
 DE Kerzenschlüssel mit Verlängerungshebel
 RU Ключ к свечам с удлинителем
 CZ Klíč na svíčky s prodlužovacím nástavcem
 HU Gyertyakulcs hosszabbítóval
 RO Cheie cu prelungitor pt. buji
 FR Douille à bougies
 IT Chiavi per candele a tubo
 ES Llave para las bujías con extensión
 CN 加长带磁万向火星



YATO	A [mm]	
YT-08163	14	15/60
YT-08164	16	15/60
YT-0818	18	10/40

EN Spark plug socket set
 PL Zestaw nasadek do świec
 DE Satz der Zündkerzenaufsätze
 RU Набор головок для свечей накаливания
 CZ Sada nástavců na svíčky
 HU Gyújtógyertyya-kulcs készlet
 RO Set chei pt. buji
 FR Ensemble d'embouts pour bougies d'allumage
 IT Set di prese per candele di accensione
 ES Juego de casquillos para bujías
 CN 摇头火花塞组套



3/8" (9.5 mm): 14, 16, 18, 21 mm

YATO	Ø	
YT-38520	3/8" (9.5 mm)	5/20

EN Joined glow plug socket set
 PL Zestaw kluczy do świec żarowych
 DE Schlüsselsatz für Glühkerzen
 RU Набор ключей к калильным свечам
 CZ Sada klíčů na žhavicí svíčky
 HU Gyertyakulcs készlet
 RO Set chei pt. buji incandescente
 FR Set de douilles à bougies
 IT Set chiavi a bussola snodate per candele
 ES Juego de llaves para bujías incandescentes
 CN 预热火花塞套筒组套

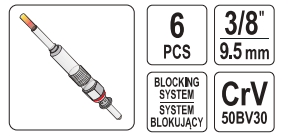

3/8" (9.5 mm): 8, 9, 10, 12, 14, 16 mm

YATO	Ø	
YT-0534	3/8" (9.5 mm)	10

EN Joined glow plug socket set
PL Zestaw kluczy do świec żarowych
DE Schlüsselsatz für Glühkerzen
RU Набор ключей к капильным свечам
CZ Sada klíčů na žhavicí svíčky
HU Gyertyakulcs készlet
RO Set chei pt. bujii incandescente
FR Set de douilles à bougies
IT Set chiavi a bussola snodate per candele
ES Juego de llaves para bujías incandescentes
CN 预热火花塞套筒组套

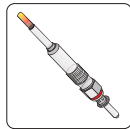

6 PCS
3/8" 9.5 mm
CrV



3/8" (9.5 mm): 8, 9, 10, 12, 14, 16 mm

YATO	○	☐
YT-05339	3/8" (9.5 mm)	10

EN Torque angle gauge with magnet
PL Kątomierz z magnesem do klucza dynamometrycznego
DE Winkelmesser mit Magnet für Drehmomentschlüssel
RU Транспортер с магнитом для динамометрического ключа
CZ Úhloměr s magnetem na momentový klíč
HU Mágneses szögmérő nyomatékkulcshoz
RO Cheie dinamometrică cu magnet
FR Rapporteur avec aimant pour clé dynamométrique
IT Goniometro con magnete per chiave dinamometrica
ES Escuadra con imán para llave dinamométrica
CN 磁性扭力规

1/2" 12.7 mm
360°
35 cm
GRADUATION OF 2 DEGREES
PODZIAŁKA PO 2 STOPNIU



YATO	○	☐
YT-05934	1/2" (12.7 mm)	10/40

EN Metal conduit bender
PL Gietarka do przewodów metalowych
DE Biegevorrichtung für Metallleitungen
RU Гибочный станок для проводов из металла

CZ Ohybačka kovových trubek
HU Hajlító fémvezetékekhez
RO Mașina de îndoit (curbat) pt. cabluri metalice
FR Cintreuse au câble de frein

IT Piegatrice per fili metallici
ES Dobladora de tubos de metal
CN 弯管器

AI ☐



125 mm max ∅ 6.0 mm ∅ 25mm

YATO	L [mm]	☐
YT-0813	125	24/96



235 mm max ∅ 12 mm ∅ 45mm

YATO	L [mm]	☐
YT-0814	235	6/48

EN Universal clutch adjustment set
PL Zestaw do centrowania tarczy sprzęgłowej
DE Universal-set, um die Kupplungsscheibe einstellen
RU Комплект для центровки дисков сцепления
CZ Univerzální sada pro nastavení spojky disk
HU Kuplung központosító készlet
RO Trusa pt. centrare ambreiaje
FR Centreur d'embrayage
IT Set di centraggio frizione
ES Herramienta alineación embrague
CN 离合器对孔校正器



9 PCS 11-25 mm ☐

∅ 11, 12, 15, 17, 19, 20, 22, 25 mm

YATO	☐
YT-06311	20



YATO	○	☐
YT-0593	1/2" (12.7 mm)	12/48

EN Torque angle gauge with clamp
PL Kątomierz z uchwytem do klucza dynamometrycznego
DE Winkellehre mit Griff für Drehmomentschlüssel
RU Угломер для динамометрического ключа
CZ Úhloměr s držákem momentového klíče
HU Fogantyús szögmérő nyomatékkulcshoz
RO Dispozitiv măsurat unghiuri cu clema
FR Clé de serrage angulaire flexible avec pince, carré
IT Goniometro per chiave dinamometrica
ES Escuadra para soporte de la llave dinamométrica
CN 扭力规



1/2" 12.7 mm
360°
50 cm
GRADUATION OF 2 DEGREES
PODZIAŁKA PO 2 STOPNIU

YATO	○	☐
YT-05933	1/2" (12.7 mm)	6/24

- EN Universal clutch adjustment set
- PL Zestaw do centrowania tarczy sprzęgłowej
- DE Kupplungs-Zentrier-Werkzeug-Satz
- RU Комплект для центровки дисков сцепления
- CZ Univerzální sada pro nastavení spojky disk
- HU Kuplung központosító készlet
- RO Trusa pt. centrat ambreiaje
- FR Centreur d'embrayage
- IT Set di centraggio frizione
- ES Herramienta alineación embrague
- CN 离合器对孔校正器





2 PCS	\varnothing 15-25 mm	\varnothing 20-27 mm	ADJUSTABLE NASTAWNY
-----------------	----------------------------------	----------------------------------	------------------------



- EN Universal clutch adjustment set
- PL Zestaw do centrowania tarczy sprzęgłowej
- DE Kupplungs-Zentrier-Werkzeug-Satz
- RU Комплект для центровки дисков сцепления
- CZ Univerzální sada pro nastavení spojky disk
- HU Kuplung központosító készlet
- RO Trusa pt. centrat ambreiaje
- FR Centreur d'embrayage
- IT Set di centraggio frizione
- ES Herramienta alineación embrague
- CN 离合器调整工具

\varnothing 15-28 mm	3 REDUCED SLIDES TELEGE REDUZIOWANE	FOR PASSENGER CARS DO AUT OSOBOWYCH	
----------------------------------	--	---	---



YATO 	YT-06313		12/24
---	-----------------	---	-------

- EN SAC clutch tool set
- PL Zestaw do obsługi sprzęgieł SAC
- DE SAC-Kupplungswartungssatz
- RU Набор для обслуживания муфт SAC
- CZ Servisní sada pro spojky SAC
- HU SAC kuplung szerelő készlet
- RO Set unelte ambreiaj SAC
- FR Kit de service d'embrayage SAC
- IT Set di attrezzi per smontaggio e montaggio della frizione SAC
- ES Kit de manejo de embragues SAC
- CN 离合器拆装工具

43 PCS	SAC			
------------------	------------	---	---	---





YATO 	YT-06315		1
---	-----------------	---	---

YATO 	YT-06312		25
---	-----------------	---	----

- EN DSG mechatronic unit remover
- PL Przyrząd do demontażu skrzyni biegów DSG
- DE Demontagevorrichtung für DSG-Schaltgetriebe
- RU Инструмент для разборки коробки передач DSG
- CZ Nástroj pro demontáž převodovky DSG
- HU DSG sebességváltó szerelő szerszám
- RO Hit indepartare unitate mecatronica DSG
- FR Outil de démontage de boîte de vitesses type DSG
- IT Leva per sbloccaggio cambio DSG
- ES Herramienta de desmontaje de caja de cambios DGS
- CN 大众奥迪DSG双离合变速箱阀体拆离器

260 mm	VAG	DSG	
------------------	------------	------------	---



YATO 	YT-05333		10/40
---	-----------------	---	-------

- EN DSG double clutch tool set
- PL Zestaw do wymiany sprzęgła DSG
- DE DSG-Kupplungsauslauchsatz
- RU Набор для замены сцепления DSG
- CZ Sada na výměnu spojky DSG
- HU DSG kuplung szerelő készlet
- RO Set de instrumente dublu ambreiaj DSG
- FR Kit de remplacement embrayage DSG
- IT Set di attrezzi per smontaggio e montaggio della frizione DSG
- ES Kit para reemplazo de embragues DGS
- CN 大众奥迪变速箱拆卸工具

6 PCS	VAG	DSG	
-----------------	------------	------------	---



YATO 	YT-06316		2
---	-----------------	---	---

- EN Tubing pipe bending tool pliers
PL Giętarka do przewodów metalowych
DE Metall-Rohrbieger
RU Гибочный станок для металлических проводов
CZ Ohývačka kovových vodičů
HU Csőhajlítógőgő
RO Cleste pt. indoarea conductelor
FR Cintreuse de tuyaux métalliques
IT Piegatrice per fili metallici
ES Dobladora de tubos de metal
CN 弯管器



YATO L [mm] 6/24
YT-08144 255

- EN Brake fluid tester
PL Tester płynu hamulcowego
DE Bremsflüssigkeitstester
RU Тестер тормозной жидкости
CZ Tester stavu brzdové kapaliny
HU Fékfolyadék tesztler
RO Tester lichid frana
FR Tester de liquide de frein
IT Tester del fluido frenante
ES Liquido de frenos tester
CN 刹车油检测器

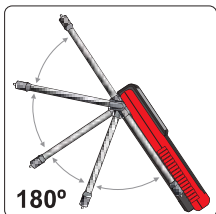

YATO 28/56
YT-72981

- EN Brake fluid tester
PL Tester płynu hamulcowego
DE Bremsflüssigkeitstester
RU Тестер тормозной жидкости
CZ Tester stavu brzdové kapaliny
HU Fékfolyadék tesztler
RO Tester lichid frana
FR Tester de liquide de frein
IT Tester del fluido frenante
ES Liquido de frenos tester
CN 刹车油测试仪

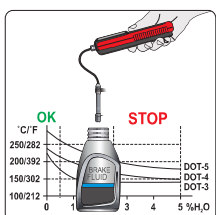

YATO 10/20
YT-72985

- EN Brake line double flaring tool
PL Prasa ręczna do przewodów hamulcowych
DE Handpresse für Bremsleitungen
RU Ручной пресс для развальцовки тормозных труб
CZ Ruční list brzdového vedení
HU Kézi prés fékcsőhöz

- RO Instrument de evazare dublă conducte frana
FR Presse à collet pour tuyaux de freins
IT Pressa manuale per tubi freno
ES Prensa manual para cables de freno
CN 铜管扩孔器



Ø 4.75, 6.35 mm

YATO 10
YT-06086

- EN Brake fluid tester
PL Tester płynu hamulcowego
DE Bremsflüssigkeitstester
RU Тестер тормозной жидкости
CZ Tester stavu brzdové kapaliny
HU Fékfolyadék tesztler

- RO Tester lichid frana
FR Tester de liquide de frein
IT Tester del fluido frenante
ES Liquido de frenos tester
CN 刹车油检测器



YATO 12/72
YT-72982

- EN Brake fluid tester
PL Tester płynu hamulcowego
DE Bremsflüssigkeitstester
RU Тестер тормозной жидкости
CZ Tester stavu brzdové kapaliny
HU Fékfolyadék tesztler
RO Tester lichid frana
FR Tester de liquide de frein
IT Tester del fluido frenante
ES Liquido de frenos tester
CN 刹车油检测器



YATO 28
YT-72986

EN Brake retainer spring tool
 PL Ściągacz sprężynki szczepek hamulcowych
 DE Montagewerkzeug für Bremsfeder
 RU Съёмник для тормозных пружин
 CZ Sada na montáž pružin brzdových čelistí
 HU Fékrugó szerelő szerszám
 RO Dispozitiv pt. montat arc pe sabot
 FR Extracleur de ressorts freins
 IT Freno scarpa di fissaggio a molla compressori
 ES Herramienta para resorte retenedor de frenos
 CN 鼓式刹车弹簧华司拆装器



YATO **YT-0685** 12/96

EN Brake spring pliers kit
 PL Zestaw do montażu szczepek hamulcowych
 DE Bremsbacken-Montageset
 RU Набор инструментов для тормозных пружин
 CZ Sada na montáž brzdových čelistí
 HU Fogókészlet fékrugóhoz
 RO Dispozitiv pt. inlocuit garnituri cilindrii receptorii
 FR Set pour le montage des mâchoires de freins
 IT Set per montaggio molle freni
 ES Juego para resortes de frenos
 CN 刹车拆卸工具组套

3 PCS FOR DRUM BRAKES DO HAMULCOW BĘBNIOWYCH



YATO **YT-0684** 6/24

EN Brake spring pliers kit
 PL Zestaw do montażu szczepek hamulcowych
 DE Bremsbacken-montage Set
 RU Набор инструментов для тормозных пружин
 CZ Sada na montáž brzdových čelistí
 HU Fogókészlet fékrugóhoz
 RO Dispozitiv pt. inlocuit garnituri cilindrii receptorii
 FR Set pour le montage des mâchoires de freins
 IT Set per montaggio molle freni
 ES Juego para resortes de frenos
 CN 刹车拆卸工具组套

8 PCS FOR DRUM BRAKES DO HAMULCOW BĘBNIOWYCH



YATO **YT-0680** 5

EN Universal brake tool set
 PL Zestaw do obsługi układów hamulcowych
 DE Bremsbacken Montageset
 RU Набор для обслуживания тормозной системы
 CZ Sada pro údržbu brzdového systému
 HU Fékrendszer karbantartó készlet
 RO Set universal pt. frane
 FR Kit de maintenance et de montage
 IT Kit di manutenzione dell'impianto frenante
 ES Kit de mantenimiento del sistema de frenos
 CN 制动系统调整工具组套

15 PCS **1/2"** **3/8"** **CrV**



YATO **YT-06802** 4

EN Inertial bent nose snap ring pliers
 PL Szczypce Segera do pierścieni zacisków hamulcowych
 DE Bremssattel- Sprengringzange
 RU Клеши зегра для тормозных суппортов
 CZ Kleště na pojistné kroužky brzdových svorek, segerovky
 HU Seeger-gyűrű fogó
 RO Cleste sigurante interior, indoit
 FR Pince seger pour bagues d'étrier de frein
 IT Pinza per anelli Seeger per freni
 ES Alicates Seeger para anillos de las pinzas de freno
 CN 挡圈钳

90° **190** mm **55** mm BENT WYGIĘTE



YATO **YT-06561** L [mm] 190 5/20

EN Brake caliper press tool
 PL Separator do hamulców larczowych
 DE Bremssattel-Presswerkzeug
 RU Распорка тормозных дисков
 CZ Přípravek na zatačení brzdových pístků
 HU Fékmunkahenger visszanyomó
 RO Separator disc ambreiaj
 FR Séparateur des freins à disque
 IT Separatore per pistoncini freno
 ES Separador de frenos de discos
 CN 棘轮制动卡钳

40-68 mm **116x60** mm **1 2 4** FOR BRAKE CALIPER PISTONS DO ZACISKŮV TLUČKOVÝCH



YATO **YT-06805** 20

EN Brake caliper press tool
PL Separator do hamulców tarczowych
DE Bremsattel-Presswerkzeug
RU Распорка тормозных дисков
CZ Připravek na zatlačení brzdových pístků
HU Fékmunkahenger visszanyomó
RO Separator disc ambreiaj
FR Séparateur des freins à disque
IT Separatore per pistoncini freno
ES Separador de frenos de discos
CN 棘轮制动卡钳

43-70 mm
110x55 mm
1 2 4
FOR BRAKE CALIPER PISTONS DO ZACISKÓW TŁOCZKOWYCH



YATO

YT-0610



6/24

EN Disc brake spreader
PL Separator do hamulców tarczowych
DE Bremskolbenrücksteller
RU Распорка тормозных дисков
CZ Připravek na zatlačení brzdových pístků
HU Fékmunkahenger visszanyomó
RO Separator disc ambreiaj
FR Séparateur des freins à disque
IT Separatore per pistoncini freno
ES Separador de frenos de discos
CN 刹车片分离器

0-65 mm
1/2" 12.7mm
21 mm

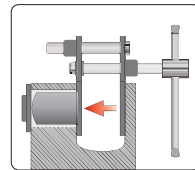

YATO

YT-0610



12/24

EN Disc brake piston tool
PL Uniwersalny klucz do wkręcania zacisków hamulcowych
DE Bremskolbenrücksteller universal
RU Ключ для тормозного поршня
CZ Univerzální klíč k montáži brzdových třmenů
HU Féknyereg ősszenyomó
RO Dispozitiv pt. impins etrier
FR Clé universelle pour pinces de frein
IT Attrezzo per l'arretamento della pinza dei freni
ES Llave para comprimir pistones del freno de disco
CN 刹车分泵拆装器

3/8" 9.5mm
CrV



CrV



General Motors, Ford, Chrysler, VW, Fiat

YATO

YT-0683



12/96

EN Brake caliper piston rewind wind back adaptors
PL Zestaw adapterów regulowanych do zacisków hamulcowych
DE Verstellbarer Adaptersatz für Bremssättel
RU Набор регулируемых адаптеров для тормозных суппортов
CZ Sada nastavitelných adaptérů pro brzdové třmeny
HU Állítható féknyereg adapter készlet
RO Adaptor pt. piston etrier frână
FR Kit adaptateurs ajustables pour étriers de frein
IT Kit di adattatori regolabili per pinze di freni
ES Juego de adaptadores ajustables para pinzas de freno
CN 可调节分泵调整器

2 PCS
3/8" 9.5mm

ADJUSTABLE RANGE REGULOWANY ROZSTAW



YATO

YT-06809



10/50

EN Brake socket bit set
PL Zestaw nasadek do zacisków hamulcowych
DE Steckschlüssel-Set für Bremssättel
RU Набор насадок для тормозных суппортов
CZ Sada násadek k čištění brzdových třmenů
HU Dugókulcs készlet féknyereg szereléshez
RO Set chei tubulare pt. saboti frana
FR Jeux de douilles pour les étriers de frein
IT Kit di attacchi per pinze di freni
ES Set de vasos para pinzas de freno
CN 刹车制动蹄套筒组套

3 PCS
1/2" 12.7mm
CrV



YATO

YT-06807



10/20

EN Brake socket bit set
PL Zestaw nasadek do zacisków hamulcowych
DE Steckschlüssel-Set für Bremssättel
RU Набор насадок для тормозных суппортов
CZ Sada násadek k čištění brzdových třmenů
HU Dugókulcs készlet féknyereg szereléshez
RO Set chei tubulare pt. saboti frana
FR Jeux de douilles pour les étriers de frein
IT Kit di attacchi per pinze di freni
ES Set de vasos para pinzas de freno
CN 刹车制动蹄套筒组套

4 PCS
1/2" 12.7mm
CrV



12, 14, 19 mm;
1/2" (12.5 mm); 10 mm; CrV

YATO

YT-06806



20

EN Brake clipper socket set
PL Zestaw narzędzi do zacisków hamulcowych
DE Bremssattel Werkzeug Satz
RU Набор специальных головок и бит для тормозных суппортов
CZ Sada nářadí pro brzdové čelisti
HU Féknyereg szerelő készlet
RO Set chei etrier de frana
FR Jeu d'outils pour étrier de frein
IT Kit di strumenti per pinze dei freni
ES Juego de herramientas para pinzas de freno
CN 刹车卡钳套筒工具组套

11 PCS
3/8" 9.5mm
1/2" 12.7mm
SPECIAL SHAPE SPECIÁLNY KSZÁLTAL
S2 CrV CrMo

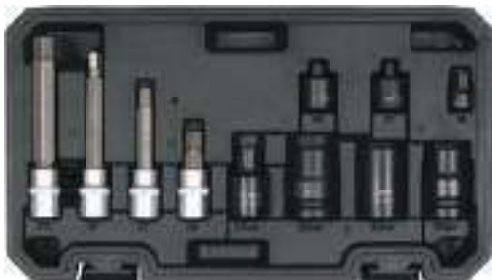

BMW, Mercedes, VAG

1/2" (12.7 mm): 11.5, 15, 20 mm (10 points/wpustów); 22 mm (7 points/wpustów); CrMo;

3/8" (9.5 mm): 7, 8, 9 mm; CrMo;

3/8" (9.5 mm): 7x72, 7x92, 9x50, 11x100 mm; AISI S2 / CrV

YATO

YT-06808



10

EN Brake clipper socket set
PL Zestaw narzędzi do zacisków hamulcowych
DE Bremssattel Werkzeug Satz
RU Набор специальных головок и бит для тормозных суппортов
CZ Sada nářadí pro brzdové čelisti
HU Féknyereg szerelő készlet
RO Set chei etrier de frana
FR Jeu d'outils pour étrier de frein
IT Kit di strumenti per pinze dei freni
ES Juego de herramientas para pinzas de freno
CN 刹车卡钳套筒工具组套

16 PCS
1/2" 12.7mm
CrMo CrV
SPECIAL SHAPE SPECIÁLNY KSZÁLTAL



1/2" (12.7 mm): 14, 19 mm (5 points / wpustów); 14, 22 mm (7 points / wpustów); 11.5, 15, 20 mm (10 points / wpustów); CrV;
1/2" (12.7 mm): 14, 17, 19 mm (L=45 mm); 7, 9, 11 mm (L=78 mm); CrMo;
1/2" (12.7 mm): M14; (L=45 mm); M18 (L=78 mm); CrMo;
1/2" (12.7 mm): 14 mm (10 points / wpustów; L=78 mm); CrMo

YATO

YT-06811



5

- EN Disc brake pad & caliper service tool kit
- PL Zestaw ręcznych separatorów do zacisków hamulcowych
- DE Werkzeugsatz von manuellen Separatoren für Bremsklemmen
- RU Набор ручных сепараторов для тормозных зажимов
- CZ Ruční sada na montáž kotoučových brzd
- HU Fékmunkahenger prés készlet
- RO Set de separatoare manuale pt. etrier frâna
- FR Set de repousse piston de frein
- IT Kit universale regolazione manuale per pistoni freni
- ES Juego de separadores manuales para abrazaderas de freno
- CN 刹车片分离器组套

11
PCS

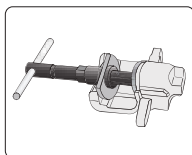

No.	zacisk przedni / front	zacisk tylny / rear
1-1	silownik	
1	płytki oporowa	
5	adapler z gniazdem	
2	Citroen: XM, Xantia	
3	Alfa Romeo, Audi, Austin, BMW, Honda, Jaguar, MB, Mitsubishi, Nissan, Rover, Toyota, VW	
4	Ford, Mazda, Subaru, Alfa Romeo, Saab	
6	Nissan	
7	Audi, Ford, Honda, Nissan, Rover, Saab, Subaru, VW	
8	General Motors	
9	General Motors	

YATO 

YT-0681



5

- EN Disc brake pad & caliper service tool kit
- PL Zestaw ręcznych separatorów do zacisków hamulcowych
- DE Werkzeugsatz von manuellen Separatoren für Bremsklemmen
- RU Набор ручных сепараторов для тормозных зажимов
- CZ Ruční sada na montáž kotoučových brzd
- HU Fékmunkahenger prés készlet
- RO Set de separatoare manuale pt. etrier frâna
- FR Set de repousse piston de frein
- IT Kit universale regolazione manuale per pistoni freni
- ES Juego de separadores manuales para abrazaderas de freno
- CN 制动钳活塞工具组套

12
PCS

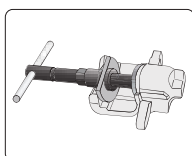

Nr krążka	zacisk przedni / front	zacisk tylny / rear
0	General Motors - zaciski 2 1/2"	
1	adapter do przedniego zacisku	
2	Citroen XM, Xantia	
3	Opel	
4	Ford, Mazda, Saab, Alfa Romeo 164 2.0, Honda, General Motors	
5	Nissan Maxima	
6	Nissan Primera, VW Golf IV	
7	Audi, Rover, Subaru, Ford, Nissan, Peugeot, Toyota, VW	
8	General Motors - zaciski 1 7/8"	
9	General Motors - zaciski 2 1/8"	
11	Adapter do tylnego zacisku	

YATO 

YT-0611



5

- EN Pneumatic brake caliper rewind tool kit
- PL Pneumatyczny zestaw do zacisków hamulcowych
- DE Pneumatik-Bremskolben-Rückstellsatz
- RU Пневматический набор к тормозным зажимам
- CZ Pneumatická sada k montáži kotoučových brzd
- HU Pneumatikus fékmunkahenger visszanyomó készlet
- RO Ansamblu pneumatic pt. cilindre de frână
- FR Set pneumatique aux séparateurs de pinces de frein
- IT Set arretratore pneumatico per pistoncini freni
- ES Juego de herramientas neumáticas para pistones de freno
- CN 气动刹车分别调整器

16
PCS

0.75
MPa

STANDARD

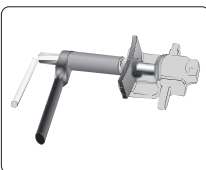
No.	zacisk przedni / front	zacisk tylny / rear
0	General Motors - zaciski 2 1/2" (12.5 mm)	
2	Citroen XM, Xantia	
3	Audi, Alfa Romeo, Fiat, Ford Fiesta, Isuzu, Honda Concerto, Jaguar (F/R), BMW, Mercedes - Benz, Mitsubishi Colt, Nissan: Almera, Stanza, Sunny, Rover, Toyota Camry, Volvo, VW: Passat, Golf GTI	
4		Ford, Mazda, Saab, Alfa Romeo 164 2.0, Honda, General Motors
5	adapter z gniazdem 3/8" (10 mm)	
6		Nissan Primera, VW Golf IV
7		Audi, Rover, Subaru, Ford, Nissan, Peugeot, Toyota, VW
8	General Motors - zaciski 1 7/8" (47.6 mm)	
9	General Motors - zaciski 2 1/8" (54 mm)	
A		Renault
E	Nissan Maxima	
F		Opel
K		Citroen
M		Ford, Cooper
N	Saab, Honda	

YATO

YT-0671



5

- EN Disc brake pad & caliper service tool kit
- PL Zestaw ręcznych separatorów do zacisków hamulcowych
- DE Werkzeugsatz von manuellen Separatoren für Bremmsklemmen
- RU Набор ручных сепараторов для тормозных зажимов
- CZ Ruční sada na montáž kotoučových brzd
- HU Fékmunkahenger prés készlet
- RO Set de separatoare manuale pt. etrier frâna
- FR Set de repousse piston de frein
- IT Kit universale regolazione manuale per pistoncini freni
- ES Juego de separadores manuales para abrazaderas de freno
- CN 刹车片分离器组套

18
PCS

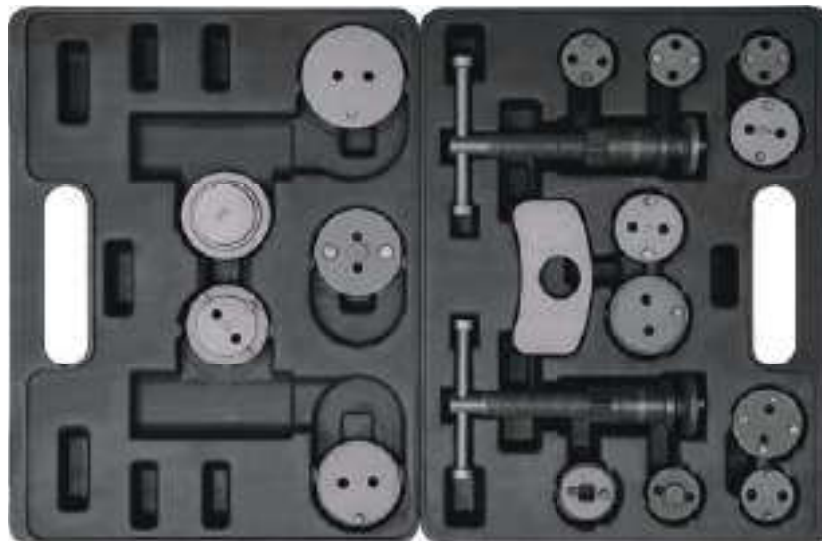
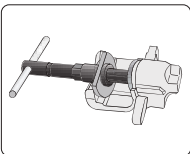
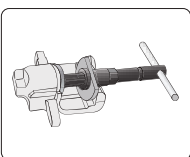
No.	zacisk przedni / front	zacisk tylny / rear
1-1		silowniki z lewym i prawym gwintem
1		plytka oporowa
5	3/8"	adapter z gniazdem
0	2 1/2"	General Motors
2	2 1/64"	Citroen XM, Xantia
3	2 5/32"	Audi, Alfa Romeo, Fiat, Ford Fiesta, Honda, Jaguar, BMW, Mercedes, Mitsubishi Colt, Nissan, Rover, Austin, Toyota Camry, Volvo, VW: Passat, Golf GTI
4	1 1/4"	Jaguar
6	1 21/32"	Ford, Mazda, Saab, Alfa Romeo 164 2.0, Honda, General Motors
7	1 21/32"	Nissan Primera, VW Golf IV
8	1 7/8"	Audi, Rover, Subaru, Ford, Nissan, Peugeot, Toyota, VW
9	2 1/8"	General Motors
E	1 21/32"	General Motors, Cadillac
F	1 1/4"	Nissan Maxima
K	2 1/8"	Opel
M	1 1/4"	Citroen
N	1 1/4"	Ford
A	1 3/16"	Saab, Honda
		Renault

YATO

YT-0682



5

- EN Disc brake pad & caliper service tool kit
- PL Zestaw ręcznych separatorów do zacisków hamulcowych
- DE Werkzeugsatz von manuellen Separatoren für Bremsklemmen
- RU Набор ручных сепараторов для тормозных зажимов
- CZ Ruční sada na montáž kotoučových brzd
- HU Fékmunkahenger prés készlet
- RO Set de separatoare manuale pt. etrier frâna
- FR Set de repousse piston de frein
- IT Kit universale regolazione manuale per pistoni freni
- ES Juego de separadores manuales para abrazaderas de freno
- CN 碟式分泵刹车调整器组套 35件



35
PCS

3/8"
9,5 mm

No.	zacisk přední / front	zacisk tylný / rear
2	2 1/64" (51,0 mm)	Citroen Xantia, Honda Prelude
3	2 5/32" (55,0 mm)	Fiat, Alfa Romeo, Isuzu, Mercedes Benz, BMW, Citroen, Ford, Honda, Jaguar, Nissan, Peugeot, Rover, Toyota, VAG, Volvo
4	1 1/4" (32,0 mm)	Jaguar
5	3/8" (10,0 mm)	Ford, Mazda, Saab, Fiat, Alfa Romeo, General Motors
7	1 21/32" (42,0 mm)	adapter z gniazdem
6	1 21/32" (42,0 mm)	Nissan, VAG, Jaguar S
8	1 7/8" (48,0 mm)	Audi, Rover, Subaru, Ford, Nissan, Peugeot, Toyota, VAG, Saab, Jaguar, GM
9	2 1/8" (54,0 mm)	General Motors
0	2 1/2" (63,5 mm)	General Motors, Cadillac
A	1 1/5" (30,5 mm)	General Motors
B	1 19/30" (41,5 mm)	Renault, BMW, Mini
C	1 19/30" (41,5 mm)	Ford, Lincoln, Subaru
D	2 1/64" (51,0 mm)	Mini, Nissan, Opel, Toyota
E	1 21/32" (42,0 mm)	Renault, Citroen
F	1 1/4" (32,0 mm)	Nissan Maxima
G	3/8" (10,0 mm)	Opel, Fiat
J	1 22/33" (42,5 mm)	Peugeot, GM
K	2 1/8" (54,0 mm)	Fiat, Alfa Romeo, Audi, Citroen, Renault, Peugeot, Ford, Nissan, Saab, VAG, Subaru, Volvo
K1	2 1/8" (54,0 mm)	Citroen, Opel
K2	1 22/23" (50,0 mm)	Renault, Citroen
P	1 19/30" (41,5 mm)	Citroen, Renault, Audi
M	1 1/4" (32,0 mm)	VAG, BMW, Ford, Lancia, Proton, Renault, Rover, Citroen
N	1 1/4" (32,0 mm)	Ford, Mini, Nissan
Z	1 3/16" (30,0 mm)	Saab, Honda, Alfa Romeo, Ford Mondeo, Lancia, Volkswagen
1, 11, 12		Ford, Mazda, Mitsubishi, Toyota Corolla
		plytka oporowa

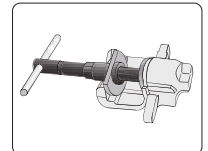
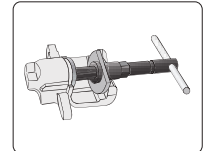

YATO

YT-06822 5

- EN Brake disc run out kit
- PL Zestaw do pomiaru bicia tarcz hamulcowych
- DE Set zum Prüfen des Bremsschlags von Bremsscheiben
- RU Набор для измерения биения тормозного диска
- CZ Sada pro měření vibrací brzdových kotoučů
- HU Féktárcsa oldalulés mérő készlet
- RO Set pt. masurat uzura discurilor de frana
- FR Kit de mesure pour disque de frein
- IT Misuratore di spessore del disco del freno
- ES Set para medir el desgaste de los discos de freno
- CN 制动盘跳动检测仪

3
PCS

+/-
0,01
mm



YATO

YT-72970 6

- EN Wheel hub grinder
- PL Szczotka do czyszczenia piast
- DE Radnabenschleifer
- RU Щетка для чистки ступицы колеса
- CZ Kartáč na čištění nábojů kol
- HU Kerékagy tisztító tárcsa
- RO Perie pt. curățarea butuc
- FR Brosse abrasive pour le nettoyage des moyeux
- IT Pulitore per mozzi ruote
- ES Cepillo abrasivo para limpieza de bujes
- CN 轮毂抛光盘

1/2"
12,7 mm

150
mm

FOR IMPACT TOOLS DO NARZEDZI UDAROWYCH

SILICON CARBIDE WĘGLIK KRZEMU



YATO

YT-25380 45

- EN Spare pad for wheel hub grinder
- PL Ściernica wymienna do szczotki do czyszczenia piast
- DE Ersatzscheibe für Radnabenschleifer
- RU Сменная щетка для чистки ступицы колеса
- CZ Kotouč náhradní na čištění nábojů kol
- HU Cserélhető tisztítókorong
- RO Rezerva pt. butuc roata polizat
- FR Meule de rechange pour brosse de nettoyage des moyeux
- IT Mola di ricambio per pulitore per mozzi ruote
- ES Disco recambio para limpieza de bujes
- CN 备用抛光盘

150
mm

FOR IMPACT TOOLS DO NARZEDZI UDAROWYCH

SILICON CARBIDE WĘGLIK KRZEMU



For YT-25380
Dla YT-25380

YATO

YT-25383 60/120

- EN Stud hub cleaner set
- PL Zestaw do czyszczenia piast i szpilek
- DE Stehbolzen-Radnabenschleifer-Satz
- RU Набор насадок для чистки болтов ступицы
- CZ Sada na čištění nábojů a čepů kol
- HU Kerékagy és tű tisztító készlet
- RO Set de curățare butuci de știfturi
- FR Kit de nettoyage pour moyeux et axes
- IT Kit di pulizia dei mozzi della ruota e spille
- ES Juego de limpieza de bujes
- CN 轮毂抛光盘

14
PCS

1/2"
12,7 mm

FOR IMPACT TOOLS DO NARZEDZI UDAROWYCH

HEAVY DUTY NYLON WZMOCNIENI NYLON



YATO

YT-25384 10/40

EN Dial indicator
PL Czujnik zegarowy
DE Messuhr
RU Индикатор часового типа
CZ Analogový senzor
HU Óramutató érzékelő
RO Indicator testare cu cadran
FR Indicateur à cadran
IT Indicatore a quadrante
ES Indicador de cuadrante
CN 百分表



0-10 mm
+/- 0.01 mm
55 mm
8 mm
1x LR44



YATO	Measuring range / Zakres pomiaru [mm]	50
YT-72450	0-10	50

EN Electronic dial indicator
PL Czujnik zegarowy elektroniczny
DE Elektronische Messuhr
RU Электронный индикатор часового типа
CZ Elektronický senzor
HU Elektronos órás érzékelő
RO Indicator testare electronic
FR Indicateur à cadran électronique
IT Indicatore quadrante elettronico
ES Indicador de cuadrante electrónico
CN 数显百分表



0-12.7 mm
+/- 0.01 mm
57 mm
8 mm
1x LR44



YATO	Measuring range / Zakres pomiaru [mm]	50
YT-72453	0-12.7	50

EN Magnetic indicator stand
PL Statyw magnetyczny
DE Magnetständer
RU Магнитный штатив
CZ Magnetický štativ
HU Mágneses állvány
RO Stand magnetic cu indicator
FR Trépied magnétique
IT Supporto magnetico
ES Soporte magnético
CN 磁性表座



50x65 x55mm
BASE / BAZA
max 70 kg



For YT-72450, YT-72453
Dla YT-72450, YT-72453

YATO	10
YT-72460	10

EN ABS and brake pressure gauge
PL Tester ciśnienia w układzie hamulcowym i ABS
DE Bremsdruck- und ABS-Tester
RU Тестер давления в тормозной системе и ABS
CZ Tester tlaku v brzdovém systému a ABS
HU ABS- és fék nyomásmérő készülék
RO Manometru pt. presiune frane si ABS
FR Testeur de pression de freinage et d'ABS
IT Misuratore pressione del sistema frenante e ABS
ES Probador de presión en el sistema de frenos y ABS
CN ABS刹车压力表

Included: pressure gauges: 0-200 kg/cm², 0-20.6 MPa (2 PCS); adaptors: #1: 7/16, M10x1.5 mm (2 PCS); #2: 7/16, M10x1 mm (2 PCS); #3: 7/16, M7x1 mm (2 PCS); #4: 7/16, M8x1.25 mm (2 PCS); #5: Ø9.34, G3/8, 24T (2 PCS); #6: Ø6.1, G1/4, 28T (2 PCS); #7: Ø10.9, 7/16, 24T (2 PCS); #8: Ø10.9, 7/16, 20T (2 PCS); #9: Ø7.64, 7/16, 24T (2 PCS); #10: M8x1 mm (2 PCS); #11: M10x1 mm (2 PCS); #12: M10x1.25 mm (2 PCS); #13: M6x1 mm (2 PCS); #A: 7/16, M10x1 mm; #B: 7/16, M10x1 mm; #C: Ø9.34, 24T; #D: M12x1 mm; #E: M11x1.5 mm; #F: Ø13, M13x1.5 mm; #G: Ø12.6, 20T; #H: Ø14, 20T; #I: Ø10.9, 24T; #J: Ø14, 18T; #K: M10x1.25; connectors: 90° (2 PCS); 45° (2 PCS); connecting pipe; connecting pipe M8x1.0 mm; angle connecting pipe M4x1.5 mm
W zestawie: manometry: 0-200 kg/cm², 0-20.6 MPa (2 szt.); adaptery: #1: 7/16, M10x1.5 mm (2 szt.); #2: 7/16, M10x1 mm (2 szt.); #3: 7/16, M7x1 mm (2 szt.); #4: 7/16, M8x1.25 mm (2 szt.); #5: Ø9.34, G3/8, 24T (2 szt.); #6: Ø6.1, G1/4, 28T (2 szt.); #7: Ø10.9, 7/16, 24T (2 szt.); #8: Ø10.9, 7/16, 20T (2 szt.); #9: Ø7.64, 7/16, 24T (2 szt.); #10: M8x1 mm (2 szt.); #11: M10x1 mm (2 szt.); #12: M10x1.25 mm (2 szt.); #13: M6x1 mm (2 szt.); #A: 7/16, M10x1 mm; #B: 7/16, M10x1 mm; #C: Ø9.34, 24T; #D: M12x1 mm; #E: M11x1.5 mm; #F: Ø13, M13x1.5 mm; #G: Ø12.6, 20T; #H: Ø14, 20T; #I: Ø10.9, 24T; #J: Ø14, 18T; #K: M10x1.25; złącza: 90° (2 szt.); 45° (2 szt.); rurka łącząca; rurka łącząca M8x1.0 mm; kąlowa rurka łącząca M4x1.5 mm



46 PCS
20.6 MPa (max.)
FOR BRAKING SYSTEMS
DO UKŁADÓW HAMULCOWYCH



YATO	5
YT-73040	5

EN Power steering tester kit
PL Zestaw diagnostyczny do wspomagania układu kierowniczego
DE Diagnoseset für Servolenkung
RU Диагностический комплект для гидроусилителя руля
CZ Sada pro diagnostiku systému posilovače řízení
HU Szervó-kormányú nyomásmérő készlet

RO Kit tester servodirectie
FR Kit contrôle direction assistée
IT Kit di diagnostica del servosterzo
ES Kit de diagnóstico para dirección asistida
CN 转向机油压力表

15 PCS

14 MPa (max.)

FOR POWER STEERING SYSTEM
DO UKŁADU KIEROWNICZEGO



Included: pressure gauge 140 bar / 2000 PSI; flexible hose 250 mm 1/8" NPT x M11 x 1.25; adapters: 1/8" NPT x M16 x 1.5 (2 PCS); 1/8" NPT x M18 x 1.5, 1/8" NPT x M11 x 1.0, M11 x 1.0 x M11 x 1.25, M11 x 1.25 x M18 x 1.5, M11 x 1.25 x M16 x 1.5 (2 PCS); M16 x 1.5 x M11 x 1.25, 1/8" NPT x M16 x 1.5, M11 x 1.25 x 1/8" NPT, 1/8" NPT x M16 x 1.5, M11 x 1.25 x M16 x 1.5
W zestawie: manometr 140 bar / 2000 PSI; elastyczny wąż 250 mm 1/8" NPT x M11 x 1.25; adaptery: 1/8" NPT x M16 x 1.5 (2 PCS); 1/8" NPT x M18 x 1.5, 1/8" NPT x M11 x 1.0, M11 x 1.0 x M11 x 1.25, M11 x 1.25 x M18 x 1.5, M11 x 1.25 x M16 x 1.5 (2 PCS); M16 x 1.5 x M11 x 1.25, 1/8" NPT x M16 x 1.5, M11 x 1.25 x 1/8" NPT, 1/8" NPT x M16 x 1.5, M11 x 1.25 x M16 x 1.5

YATO	10
YT-73045	10

EN Universal hydraulic flaring tool set
PL Prasa hydrauliczna do przewodów hamulcowych i klimatyzacji
DE Hydraulisches Bördelgerät für Bremsleitungen
RU Гидравлический пресс для тормозных проводов и кондиционера
CZ Hydraulický lis pro výrobu brzdového vedení
HU Hidraulikus fék- és légkondicionáló cső peremező készlet
RO Kit hidraulic universal pt. evazare
FR Presse à collet hydraulique pour tuyaux de frein et de climatisation
IT Pressa idraulica per tubi freno e per aria condizionata
ES Kit de abocardador hidráulico para tubos de freno y de aire acondicionado
CN 制动管子扩孔器

14 PCS

Cu

BRASS
MOSIADZ

AI

STEEL
STAL



Flare forming tools / Kończówki do spęczenia:
OP1: 4.75 mm (3/16"), 5 mm, 6.35 mm (1/4")
DIN: 4.75 mm, 5 mm
OP2: 4.75 mm (3/16"), 5 mm, 6.35 mm (1/4")
DIN: 6.35 mm

YATO	5
YT-06088	5

EN Air brake bleeder
 PL Urządzenie pneumatyczne do wymiany płynu hamulcowego
 DE Druckluft-Bremsenentlüfter
 RU Устройство для замены тормозной жидкости
 CZ Sada na odvzdušnění brzdové soustavy a hydraulické spojky
 HU Pneumatikus eszköz a fékfolyadék cseréjére
 RO Aparat de schimb at lichid frână
 FR Purger de frein et d'embrayage pneumatique
 IT Strumento per la sostituzione del liquido freni
 ES Sangrado del freno de aire comprimido
 CN 气动刹车油更换机



0.27 MPa
 5L
 6m
 STANDARD

EN Brake and clutch bleeder bleeding vacuum pump kit
 PL Zestaw pneumatyczny do odpowietrzania układu hamulcowego
 DE Pneumatischer Bremsen-Entlüftungs Satz
 RU Пневматический комплект для прокачки тормозной системы
 CZ Pneumatická sada pro odvzdušnění brzdového systému
 HU Pneumatikus fék légtelenítő készlet
 RO Kit pompa de vid pt. aerisire frana si ambreiaj
 FR Kit de purge d'air pour freins
 IT Kit pneumatico per lo spurgo dell'impianto frenante
 ES Kit neumático para purgar el sistema de freno
 CN 刹车油更换机



0.62 MPa
 1L
 180cm
 STANDARD

$L_{PA} \leq 70$ dB; $L_{WA} \leq 85$ dB; $a_n \leq 2,5$ m/s²



YATO		1
YT-06845		

YATO		20
YT-06835		

EN Coil spring clamp
 PL Ściągacz do sprężyn
 DE Federspanner
 RU Съёмник пружин
 CZ Stahovák pružin tlumičů automobilů
 HU Rugóösszehúzó
 RO Presa pt. arcuri
 FR Compresseurs de ressort
 IT Estrattore per smonta molle

ES Extractor de muelles
 CN 弹簧夹



2 PCS
 1/2" 12.7mm
 21 mm

90x200 mm



82x370 mm CrV



COLD FORGED KUTE NA ZIMNO

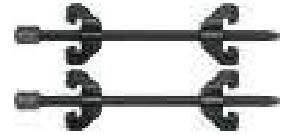

YATO		Ø [mm]	L [mm]	
YT-0605		90	200	5/10

YATO		Ø [mm]	L [mm]	
YT-2544		82	370	8

YATO		Ø [mm]	L [mm]	
YT-2546		82	280	8
YT-2547		82	355	8

EN Coil spring compressor
 PL Ściągacz wewnętrznym do sprężyn
 DE Innenabzieher für Federn
 RU Внутренний съёмник для пружин
 CZ Vnitřní stahovák pružin
 HU Belső rugóösszehúzó
 RO Dispozitiv compresat arcuri
 FR Extracteur interne de ressorts
 IT Estrattore interno per molle
 ES Extractor para muelles interior
 CN 弹簧压缩器



20 mm
 145 mm
 300 mm
 DROP FORGED KUTE

EN Macpherson spring dumper extractor
 PL Ściągacz do sprężyn MacPhersona
 DE Abziehvorrichtung für Federn von MacPherson
 RU Съёмник пружин подвески Макферсона
 CZ Stahovák pružin McPherson
 HU MacPherson rugó összehúzó
 RO Extractor de arcuri MacPherson
 FR Compresseurs de ressort MacPherson
 IT Estrattore per molle MacPherson
 ES Desmontador para los resortes de MacPherson
 CN 弹簧压缩器



100-250 mm max 2900kg
 CrMo SCM415
 3 YEARS OF WARRANTY

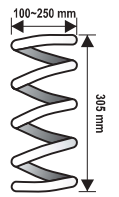
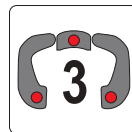

YATO		Ø [mm]	L [mm]	
YT-25472		145	300	6/12

YATO		2
YT-2535		

EN Interchangeable fork spring compressor and removal tool
 PL Ściągacz do sprężyn MacPhersona z wymiennymi uchwyłami
 DE Abziehvorrichtung für MacPherson-Federn mit austauschbaren Halterungen
 RU Стяжка для снятия пружин Макферсона со сменными полукольцами
 CZ Stahovák pružin McPherson s vyměnitelnými čelistmi
 HU MacPherson rugó összehúzó cserélhető pófákkal
 RO Ancoră suspensie MacPherson cu mânere interschimbabile
 FR Compresseurs de ressort MacPherson
 IT Smonta ammortizzatori per sospensioni MacPherson
 ES Extractor de resortes MacPherson con mangos intercambiables
 CN 免拆式减震弹簧压缩器



7 PCS
 65-125 mm
 88-160 mm
 126-212 mm max 1500kg

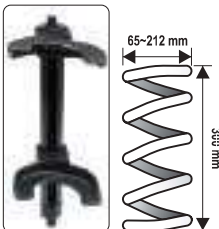

YATO		1
YT-2536		

EN Drive nut set
PL Zestaw nasadek do amortyzatorów
DE Stossdämpfer Nutmutter Einsätze
RU Набор головок для амортизаторов
CZ Sada hlavic na uložení tlumiče
HU Lengéscsillapítókiszedő szet

RO Set prezoane
FR Set des embouts aux amortisseurs
IT Set di chiavi per aria condizionata
ES Juego de boquillas de amortiguadores
CN 拆装减震器套件组套



5
PCS

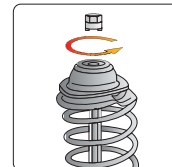

10.5 mm (VW Golf rear), 12.5 mm (VW Golf front), 14.5 mm (VW Polo, Golf, Passat, Audi 80), 14.5 mm (Austin Maestro), 14.0 mm (Mercedes Benz C-Class (W203))

YATO

YT-0621

Size / Rozmiar [mm]

10.5, 12.5, 14.5, 14.5, 14



12/48

EN Tumbuckle for shock absorber's top lid
PL Zestaw kluczy do mocowania amortyzatorów
DE Schlüsselset zum Befestigen der Stoßdämpfer
RU Набор ключей для крепления амортизаторов
CZ Sada klíčů k montáži tlumičů
HU Kulcskészlet lengéscsillapítók rögzítéséhez
RO Set chei pt. fixare amortizoare
FR Set de clés pour amortisseurs
IT Set chiavi per montare ammortizzatori
ES Juego de llaves para la instalación de amortiguadores
CN 避震器拆卸器



39
PCS

CrMo
SCM415

CrV
6140

CrV
50BV30

8660

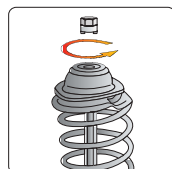

	size / rozmiar	type of car / model samochodu		size / rozmiar	type of car / model samochodu
<p>CrMo SCM415</p>	10.5 x 3.5 mm	VW Golf Rear Axle	<p>CrV 6140</p>	D5	Nissan
	12.5 x 3.5 mm	VW Golf Front Axle		D10	Nissan, Ford
	14.5 x 5 mm	VW Polo, Golf, Passat, Audi 80		8 mm	Mercedes-Benz
	14.5 x 3 mm	Austin Maestro		9 mm	Opel/Vauxhall, Chrysler
	14 x 2.5 mm	Mercedenz-Benz W203 (C-class), W209 (CLK)		10 mm	Chrysler, Ford
<p>CrV 50BV30</p>	14 mm	Honda, Nissan	<p>STEEL 8660</p>	11 mm	Japanese Cars
	16 mm	VW, Audi, Seat, Fiat		5 mm	Honda
	17 mm	Ford, VW, Audi, Seat, Fiat		6 mm	Seat, Fiat, Citroen, Peugeot, Ford, Opel, Renault, Japanese Cars, BMW
	18 mm	Ford, VW, Audi, Seat, Rover, Fiat, Opel, Peugeot, Renault, Japanese Cars		7 mm	VW, Audi, Seat, Fiat, Citroen, Peugeot, Mercedes-Benz (W203), Renault
	19 mm	VW, Audi, Seat, Citroen, Fiat, Opel, Peugeot, Toyota		8 mm	Mercedes-Benz
	21 mm	Mercedenz-Benz W203, Chrysler, VW, Audi, Ford, Japanese Cars		3 mm	Mercedes-Benz, Opel, Renault
	22 mm	VW, Audi, Seat, Citroen, Fiat, Opel, Peugeot, Renault, BMW		3.5 mm	Chrysler, Ford, Citroen, Peugeot
	24 mm	Volvo		4 mm	Citroen, Peugeot
	27 mm	VW, Audi, Citroen, Peugeot		M12	Opel/Vauxhall
	<p>CrV 6140</p>	4 mm		Nissan	<p>STEEL 8660</p>
5.2 mm		VW, Audi, Nissan	T60	Ford	
6 mm		VW, Audi, Renault			
6.3 mm		Nissan			
7 mm		VW, Audi, Seat, Fiat			
8 mm		Seat, Fiat			
9 mm		Japanese Cars			
10 mm		Seat, Fiat, Volvo			
12 mm	Seat, Fiat				

YATO

YT-0628



3

EN Tire valve stem inserter
PL Przeciagacz do zaworków gumowych
DE Abziehvorrichtung für Gummiventile
RU Протыжка к резиновым клапанам

CZ Páka k provlákání bezdušových ventilů
HU Szűfeszesség mérő
RO Broșă pt. supapele cauciucate
FR Levier tire-valve

IT Brocca valvola di gomma
ES Brocha de tracción para las válvulas de goma
CN 气门插入工具

290
mm

RUBBER
VALVES
ZAWORY
GUMOWE



YATO

YT-0619

L [mm]

290



12/72

EN Wheel balance pliers
 PL Szczypce do wyważania kół
 DE Auswuchtgewicht-Zange
 RU Клеши для балансировки колес
 CZ Kleště pro vyvažování kol
 HU Centrifúly szerelő szerszám
 RO Cleste pt. cauciuc
 FR Pincés pour le contrepois à agrafe de roue de voiture
 IT Pinze per equilibrio ruota
 ES Tenazas de equilibrar ruedas
 CN 平衡钳

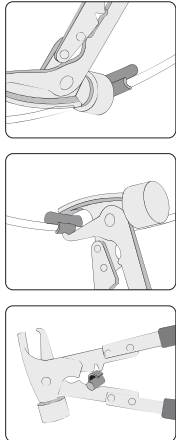

EN Deep thin wall impact sockets
 PL Zestaw nasadek uderowych do felg aluminiowych
 DE Alu-Felgen Kraft-Stecknüsse
 RU Набор головок для алюминиевых дисков
 CZ Sada nástrčných kľúčů na alu ráfky
 HU Hosszított dugókulcs készlet, könnyűfém felnikhez
 RO Set chei adanci pt. plite aluminiu
 FR Set de douilles profondes à choc
 IT Set di chiavi a bussola per dadi ruota di alluminio
 ES Juego de boquillas de percusión para llantas de aluminio
 CN 风动薄壁长套筒

3 PCS	1/2" 12.7mm		
AS-DRIVE	CrMo SCM440		



- For service station and tire workshops
- For maximum impact loads
- Drive locks
- Ultra thin walls and nylon cover for working with alu rims
- Anodised colour finish for fast identification of size
- Dla serwisów i warsztatów oponiarskich
- Do największych obciążeń uderowych i tętniących
- Zamki blokujące
- Ultracienkie ścianki i nylonowe pokrycie do pracy z felgami aluminiowymi
- Anodowane, kolorowe wykończenie dla szybkiej identyfikacji rozmiaru

YATO	
YT-0643	12/48

YATO	
YT-1056	1/2" (12.7 mm) 12/24

EN Deep aluminium wheel nut socket set
 PL Zestaw nasadek uderowych długich do felg aluminiowych
 DE Alu-Felgen Kraft-Stecknüsse, lang
 RU Набор длинных ударных насадок для алюминиевых дисков
 CZ Sada dlouhých nárazových zásuvek pro hliníkové disky
 HU Hosszított dugókulcs készlet, könnyűfém felnikhez
 RO Set chei adanci pt. plite aluminiu
 FR Jeu de douilles à chocs longues pour jantes en aluminium
 IT Kit di punte a percussione lunghe per cerchi in lega
 ES Juego de vasos de impacto largos para llantas de aluminio
 CN 加长轮胎保护套筒

6 PCS	1/2" 12.7mm	150 mm
		CrMo
AS-DRIVE		

EN Deep thin wall impact sockets
 PL Zestaw nasadek uderowych do felg aluminiowych
 DE Alu-Felgen Kraft-Stecknüsse
 RU Набор головок для алюминиевых дисков
 CZ Sada nástrčných kľúčů na alu ráfky
 HU Hosszított dugókulcs készlet, könnyűfém felnikhez
 RO Diblul de impact cu mufare in interior
 FR Set de douilles profondes à choc
 IT Set di chiavi a bussola per dadi ruota di alluminio
 ES Juego de boquillas de percusión para llantas de aluminio
 CN 风动薄壁长套筒

10 PCS	1/2" 12.7mm	CrMo
AS-DRIVE		



YATO	
YT-10563	1/2" (12.7 mm) 10



YATO	
YT-10564	1/2" (12.7 mm) 5

EN Emergency wheel nut remover
 PL Nasadki uderowe do wykręcania śrub zabezpieczających
 DE Schlag-Steckschlüsselsatz für Radsicherungsschrauben
 RU Ударные головки для снятия предохранительных винтов
 CZ Sada nástrčných hlavic pro demontáž bezpečnostních šroubů
 HU Útve-dugókulcs készlet biztonsági csavarok kihajtásához
 RO Set tubulare speciale pt. prezoane rotunjite
 FR Jeu d'outils d'impact pour le dévissage des vis de sécurité
 IT Chiavi ad impatto per estrazione viti di sicurezza
 ES Vasos de impacto para desmontar tornillos de seguridad
 CN 应急螺母组套

4 PCS
1/2" 12.7mm
17-26 mm
CrMo

EN Wheel lock lug nut removal set
 PL Zestaw nasadek do wykręcania śrub zabezpieczających
 DE Steckschlüsselsatz für Radsicherungsschrauben
 RU Набор головок для снятия предохранительных винтов
 CZ Sada hlavic pro demontáž bezpečnostních šroubů
 HU Dugókulcs készlet biztonsági csavarok kihajtásához
 RO Set de demontare a piulițelor de blocare a roților
 FR Jeu d'outils pour le dévissage des vis de sécurité
 IT Set di bussole per svitare bulloni di sicurezza
 ES Juego de vasos para destornillar tornillos de seguridad
 CN 弹簧锁拆卸套筒

10 PCS	18-25 mm	CrMo



YATO	
YT-06030	1/2" (12.7 mm) 10/20



YATO	
YT-060302	5

EN Steering and suspension indicator
PL Przyrząd do sprawdzania luzów zawieszenia
DE Vorrichtung zur Kontrolle des Aufhängungsspiels
RU Инструмент для проверки люфта подвески
CZ Zařízení pro kontrolu vůle zavěšení
HU Futómű lazulás ellenőrző
RO Indicator de direcție și suspensie
FR Dispositif de contrôle du jeu de la suspension
IT Strumento per il controllo giochi delle sospensioni
ES Equipo para comprobar juegos en la suspensión
CN 底盘间隙测试工具

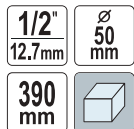

YATO	○	📦
YT-17490	1/2" (12.7 mm)	20

EN Folding cross wrench
PL Składany klucz do kół w etui
DE Radmutternschlüssel
RU Балонный крестовой разборный ключ с чехлом
CZ Skládací křížový klíč na maticе
HU Összecsukható kereszt csavarkulcs
RO Cheie cruce pt. șuruburi roți
FR Clé démonte roue en croix démontable
IT Pierevole cress chiave
ES llave para las ruedas de automóviles
CN 可折叠十字扳手

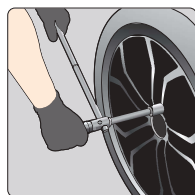

📦 1/2" (12.7 mm): 17, 19, 21, 23 mm

YATO	○	📦
YT-08035	1/2" (12.7 mm)	10

EN Folding cross wrench
PL Składany klucz do kół
DE Klappbarer Radschlüssel
RU Складной ключ для колес
CZ Skládací klíč na kola
HU Összecsukható kerékkulcs

RO Cheie in cruce plianta
FR Clé à roue pliante
IT Chiave per ruote pieghevole
ES llave de rueda plegable
CN 可折叠十字扳手



📦 1/2" (12.7 mm): 17, 19, 21, 23 mm

YATO	○	📦
YT-08033	1/2" (12.7 mm)	5/10

EN Cross rim wrench
PL Krzyżakowy klucz do kół
DE Kreuzschlüssel
RU Ключ-крест балонный
CZ Klíč na kola křížový
HU Kereszt kerékkulcs



YATO	Size / Rozmiar [mm]	📦
YT-0800	17x19x21x22	10
YT-0801	17x19x21x1/2" (12.7 mm)	10
YT-0802	24x27x32x3/4" (19.0 mm)	3

EN L-type wheel wrench
PL Klucz do kół rozsuwany
DE Teleskop-Radmutternschlüssel
RU Ключ балонный телескопический
CZ Teleskopický klíč na kola
HU Kihúzható kerékkulcs
RO Cheie pt. roți extensibilă
FR Clé à roues extensible
IT Chiave telescopica smontaruota
ES llave para ruedas extensible
CN 轮胎套筒扳手组套

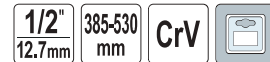

📦 1/2" (12.7 mm): 17x19 mm, 21x23 mm

YATO	○	📦
YT-08040	1/2" (12.7 mm)	5/10

EN Tire expander
PL Rozpierek do opon
DE Reifenspreizer
RU Борторасширитель
CZ Roztahovák pneumatik
HU Abroncs leszedő szerző

RO Dispozitiv intins cauciucuri
FR Écarteur de pneus
IT Divaricatore per pneumatici
ES Esparcador de neumáticos
CN 扩胎器



YATO	L [mm]	📦
YT-08120	450	9

EN Electric impact wrench
 PL Elektryczny klucz udarowy
 DE Elektro-Schlagschrauber
 RU Электрический гайковерт
 CZ Elektrický rázový uťahovák
 HU Elektromos ütvecsavarozó

RO Pistol de impact electric
 FR Clé à choc électrique
 IT Avvitatore elettrico ad impulso
 ES llave de impacto eléctrica
 CN 电动冲击扳手



230V~50Hz	450 W
450 Nm	0-3300 min ⁻¹
0-3300 min ⁻¹	1/4" 6.3 mm
1/2" 12.7 mm	4 m

17, 19, 21, 23 mm



$L_{pA} = 96,0 \pm 3,0$ dB; $L_{wA} = 107,0 \pm 3,0$ dB; $a_n = 17,648 \pm 1,5$ m/s²

YATO	[W]	
YT-82020	450	4

EN Electric impact wrench
 PL Elektryczny klucz udarowy
 DE Elektro-Schlagschrauber
 RU Электрический гайковерт
 CZ Elektrický rázový uťahovák
 HU Elektromos ütvecsavarozó

RO Pistol de impact electric
 FR Clé à choc électrique
 IT Avvitatore elettrico ad impulso
 ES llave de impacto eléctrica
 CN 电动冲击扳手



230V~50Hz	1020 W
600 Nm	0-2600 min ⁻¹
0-2700 min ⁻¹	1/4" 6.3 mm
1/2" 12.7 mm	4 m

17, 19, 21, 23 mm



$L_{pA} = 100,0 \pm 3,0$ dB; $L_{wA} = 111,0 \pm 3,0$ dB; $a_n = 18,9 \pm 1,5$ m/s²

YATO	[W]	
YT-82021	1020	3

EN Impact tool set
 PL Zestaw narzędzi udarowych
 DE Schlagwerkzeugsatz
 RU Набор инструментов ударных
 CZ Sada příklepových nářadí
 HU Ütvecsavarozó szerszámkészlet
 RO Set pistol impact
 FR Clé à choc avec jeu d'outils
 IT Set di chiavi a percussione
 ES Juego de herramientas de impacto
 CN 锂电冲击扳手套筒组套



21 PCS	18 V Li-Ion	1/2" 12.7 mm	700 Nm
0-2600 min ⁻¹	0-5000 min ⁻¹	3.0 Ah	1.5h



1/2" (12.7 mm): 17, 19, 21 mm (L=87 mm); CrMo;

1/2" (12.7 mm): 12, 13, 14, 15, 16, 17, 18, 19, 20, 21, 22, 23, 24 mm; CrMo;

1/2" (12.7 mm); (L=75 mm); CrMo

$L_{pA} = 86,0 \pm 3,0$ dB; $L_{wA} = 97,0 \pm 3,0$ dB; $a_n = 7,58 \pm 1,5$ m/s²

YATO		[V d.c.]	
YT-82807	1/2" (12.7 mm)	18	2

18V
Li-Ion

EN Tire lever
PL Lyżka do opon
DE Reifenmontierhebel
RU Прибор для шиномонтажа
CZ Montážní páka na pneumatiky
HU Gumiabroncs kar
RO Levier pt. roti
FR Cuillère à pneus
IT Leva per pneumatici
ES Desmontable para las llantas
CN 轮胎起子



YATO			YATO		
	L [mm]			L [mm]	
YT-0807	300	20	YT-0809	500	5/20
YT-0808	400	20	YT-0810	600	5/20

EN Tire lever
PL Lyżka do opon
DE Reifenmontierhebel
RU Прибор для шиномонтажа
CZ Montážní páka na pneumatiky
HU Gumiabroncs kar
RO Levier pt. roti
FR Cuillère à pneus
IT Leva per pneumatici
ES Desmontable para las llantas
CN 撬棒



YATO		L [mm]	
YT-0811		380	10/50

EN Rectangular telescopic inspection mirror
PL Lusterko inspekcyjne
DE Teleskop Inspektionsspiegel
RU Зеркало инспекционное телескопическое
CZ Zrcátko kontrolní teleskopické
HU Vizsgáló tükör, teleszkópos nyéllel
RO Oglindă telescopică pt. inspecție
FR Miroir d'inspection
IT Telescopio ispezione specchio
ES Espejo rectangular telescópico de inspección
CN 可伸缩矩形检测镜



YATO		
YT-0660		12/144

EN LED lighted telescopic inspection mirror
PL Lusterko inspekcyjne z lampką
DE Prüfspiel mit Beleuchtung
RU Зеркало досмотровое с подсветкой
CZ Inspekční zrcátko s lampou
HU Vizsgáló tükör, lámpával
RO Oglindă pt. inspecție cu lampă
FR Miroir d'inspection avec lampe
IT Specchio di ispezione con lampada
ES Espejo de control con lámpara
CN 带灯检测镜



YATO		
YT-0663		10/100

EN Telescopic magnetic pick up tool
PL Chwytnak teleskopowy z magnesem
DE Teleskop magnet Heber
RU Захват магнитный телескопический
CZ Patka teleskopická magnetická
HU Felszedő mágnes, teleszkópos nyéllel
RO Telescop magnetic
FR Capteur magnétique
IT Telescopio magnete
ES Herramienta levantadora magnética, telescópica
CN 可伸缩拾器



YATO		
YT-0661		12/144

EN Telescopic magnetic pick up tool
PL Chwytnak teleskopowy z magnesem
DE Teleskop magnet Heber
RU Захват магнитный телескопический
CZ Patka teleskopická magnetická
HU Felszedő mágnes, teleszkópos nyéllel
RO Telescop magnetic
FR Capteur magnétique
IT Telescopio magnete
ES Herramienta levantadora magnética, telescópica
CN 带灯可伸缩拾器



YATO		
YT-06611		12/144

EN 3 in 1 pick up tool
PL Zestaw do podnoszenia 3 w 1
DE 3 in 1 Hebeset
RU Подъемный набор 3 в 1
CZ Zvedací sada 3 v 1
HU 3 az 1-ben felszedő készlet
RO Dispozitiv 3 in 1 pt. recuperat
FR Kit de levage 3 en 1
IT Kit per sollevamento 3 in 1
ES Kit de elevación 3 en 1
CN 带灯拾器



YATO		
YT-06613		10/60

EN Telescopic magnetic pick up tool
PL Chwytnak teleskopowy z magnesem
DE Teleskop magnet Heber
RU Захват магнитный телескопический
CZ Patka teleskopická magnetická
HU Felszedő mágnes, teleszkópos nyéllel
RO Telescop magnetic
FR Capteur magnétique
IT Telescopio magnete
ES Herramienta levantadora magnética, telescópica
CN 可伸缩磁性拾器



YATO		L [mm]	
YT-0860		590-990	6/24

EN Telescopic pick up and mirror set
 PL Zestaw inspekcyjny: lusterko + chwytak
 DE Inspektionssatz: Spiegel + Greifer
 RU Проверочный набор + держатель и зеркальце
 CZ Inspekční souprava: zrcadlo + držák
 HU Teleszkópos ellenőrző készlet
 RO Garnitură de control: oglindă + benă
 FR Kit miroir + grappin
 IT Set per ispezione: specchio + supporto
 ES Juego de inspección: espejo + cuchara de mordazas
 CN 检测镜、拾拾器组套

4 PCS

170-640 mm

240-940 mm

max 0.5 kg

TELESCOPIC HANDLE
UCHWYT
TELESKOPOWY



EN Inspection set
 PL Zestaw inspekcyjny
 DE Inspektionssset
 RU Инспекционный набор
 CZ Inspekční sada
 HU Teleszkópos ellenőrző készlet
 RO Set de inspecție
 FR Jeu d'inspection
 IT Strumenti d'ispezione
 ES Juego herramientas inspección
 CN 套磁性伸缩拾器

5 PCS

SS
STAINLESS STEEL
STAL NIERZĘDZWA

TELESCOPIC HANDLE
UCHWYT
TELESKOPOWY

FLEXIBLE HANDLE
ELASTYCZNY
UCHWYT

LED

2x CR2032

4x LR44



172-570 mm, 84x53 mm;
 181-779 mm, Ø15 mm;
 129-648 mm, Ø5 mm;
 240-695 mm, Ø50 mm;
 283-880 mm, 84x53 mm

YATO

YT-0662

10/40

YATO

YT-06622

48

EN Magnetic parts tray
 PL Miska magnetyczna
 DE Magnetschale
 RU Магнитный поднос
 CZ Miska magnetická
 HU Mágneses tálca
 RO Tava magnetica
 FR Bol magnétique
 IT Ciotola magnetica
 ES Bandeja de accesorios magnética
 CN 磁性工具盘



Ø 110 mm

YATO

YT-08295

12/48



Ø 150 mm

YATO

YT-0830

12/48

EN Magnetic parts tray
 PL Miska magnetyczna
 DE Magnetschale
 RU Магнитный поднос
 CZ Miska magnetická
 HU Mágneses tálca
 RO Tava magnetica
 FR Bol magnétique
 IT Ciotola magnetica
 ES Bandeja de accesorios magnética
 CN 磁力盘

152x68 mm



YATO

YT-08312

48

EN Magnetic parts tray
 PL Miska magnetyczna
 DE Magnetschale
 RU Магнитный поднос
 CZ Miska magnetická
 HU Mágneses tálca
 RO Tava magnetica
 FR Bol magnétique
 IT Ciotola magnetica
 ES Bandeja de accesorios magnética
 CN 磁性工具盘

350x150 mm



YATO

YT-0831

6/12

EN Magnetic parts tray
 PL Miska magnetyczna
 DE Magnetschale
 RU Магнитный поднос
 CZ Miska magnetická
 HU Mágneses tálca
 RO Tava magnetica
 FR Bol magnétique
 IT Ciotola magnetica
 ES Bandeja de accesorios magnética
 CN 磁力碗

Ø 110 mm

0.10 T (TESLA)



YATO

YT-08304

24

EN Magnetic parts tray
 PL Miska magnetyczna
 DE Magnetschale
 RU Магнитный поднос
 CZ Miska magnetická
 HU Mágneses tálca
 RO Tava magnetica
 FR Bol magnétique
 IT Ciotola magnetica
 ES Bandeja de accesorios magnética
 CN 磁性工具盘

Ø 150 mm

0.10-0.12 T (TESLA)



YATO

YT-08305

20

EN Magnetic parts tray
 PL Miska magnetyczna
 DE Magnetschale
 RU Магнитный поднос
 CZ Miska magnetická
 HU Mágneses tálca
 RO Tava magnetica
 FR Bol magnétique
 IT Ciotola magnetica
 ES Bandeja de accesorios magnética
 CN 磁力碗

2 PCS

Ø 108 mm

Ø 150 mm

0.10 T (TESLA)



YATO

YT-08302

6/24

EN Magnetic parts tray
PL Sortownik magnetyczny
DE Magnet-Sortierbox
RU Сортировщик
CZ Magnetický třídící
HU Mágneses rendszerező

RO Tava magnetica pt. piese
FR Rangement compartimenté magnétique
IT Separatore magnetico
ES Clasificador magnético
CN 磁力盘

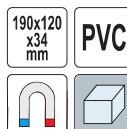

YATO YT-08320 48

EN Magnetic wristband
PL Opaska magnetyczna
DE Magnetisches Armband
RU Магнитный браслет
CZ Magnetický náramek pro kutily
HU Mágneses karkötő
RO Bratara magnetica pt. scule
FR Bracelet magnétique
IT Braccialeto magnetico
ES Pulsera magnética
CN 磁性腕带



YATO YT-74050 L [mm] 340 50

EN Magnetic screwdriver rack
PL Uchwyt magnetyczny na wkrętaki
DE Magnetische Halterung für Schraubendreher
RU Магнитный держатель для отверток
CZ Magnetický držák šroubováků
HU Mágneses csavarhúzó tartó

RO Raft magnetic pt. surubelnite
FR Mandrin magnétique pour tournevis
IT Supporto magnetico per punte
ES Soporte magnético para destornilladores
CN 磁性螺丝刀架

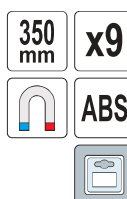

YATO YT-08353 L [mm] 350 6/24

EN Magnetic pliers rack
PL Uchwyt magnetyczny na narzędzia
DE Magnetischer Werkzeughalter
RU Магнитный держатель для инструментов
CZ Magnetický držák na nářadí
HU Mágneses szerszámtartó

RO Raft magnetic pt. clesti
FR Fixation magnétique pour outils
IT Supporto magnetico per attrezzi
ES Soporte magnético para herramientas
CN 磁性钳子架



YATO YT-08354 L [mm] 350 6/24

EN Magnetic tool holder
PL Listwa magnetyczna
DE Magnet Werkzeughalter
RU Магнитная рейка
CZ Magnetický držák nářadí
HU Mágneses tartó

RO Suport magnetic
FR Barre et porte outil magnétique
IT Striscia magnetica
ES Bandeja de accesorios magnética
CN 磁性工具架



YATO YT-0835 4/16

EN Magnetic wristband
PL Opaska magnetyczna
DE Magnetisches Armband
RU Магнитный браслет
CZ Magnetický náramek pro kutily
HU Mágneses karkötő
RO Bratara magnetica pt. scule
FR Bracelet magnétique
IT Braccialeto magnetico
ES Pulsera magnética
CN 磁性腕带



YATO YT-74051 L [mm] 310 50

EN Magnetic holder for tools
PL Uchwyt magnetyczny na narzędzia
DE Magnethalter für Schlagschrauber
RU Магнитный держатель для ударного гайковерта
CZ Magnetický držák nářadí
HU Mágneses tartó
RO Suport magnetic pt. scule pneumatice
FR Support magnétique pour outils pneumatiques
IT Fissaggio magnetico per chiave ad impulsi pneumatica
ES Soporte magnético para llave de impacto
CN 磁性喷枪架



YATO YT-08707 5/10

EN Workshop seat
 PL Taboret warsztatowy
 DE Werkstatt-Sitz
 RU Табурет рабочий
 CZ Dílenský taburet
 HU Műhely zsámoly
 RO Taburet atelier
 FR Tabouret d'atelier
 IT Sgabello da officina
 ES Taburete de taller
 CN 修车凳

450x270
x350
mm
 max 140 kg
 360°
 4x



YATO

YT-08792



1

EN Workshop seat with drawers
 PL Taboret warsztatowy z szufladami
 DE Werkstatthocker mit Schubladen
 RU Табурет для мастерской с выдвижными ящиками
 CZ Stolička do dílny se zásuvkami
 HU Műhelyszék fiókkal
 RO Scaun atelier cu sertare
 FR Tabouret d'atelier avec tiroirs
 IT Sgabello da officina con cassetti
 ES Taburete de taller con cajones
 CN 双抽屉修车凳

530x470
x360
mm
 2x
 max 150 kg
 360°
 4x
 2x
 BRAKE
HAMULEC



YATO

YT-08790



1

EN Workshop seat with drawer
 PL Taboret warsztatowy z szufladą
 DE Werkstatthocker mit Schublade
 RU Табурет для мастерской с выдвижным ящиком
 CZ Stolička do dílny se zásuvkou
 HU Műhelyszék fiókkal
 RO Scaun atelier cu tava
 FR Tabouret d'atelier avec un tiroir
 IT Sgabello da officina con cassetto
 ES Taburete de taller con cajón
 CN 轻型修车凳

440x360
x390
mm

1x

max 150 kg

360°
4x



YATO

YT-08791



2

EN Adjustable roller stool with drawers
 PL Siedzisko warsztatowe z szufladami
 DE Werkstatt-Sitz mit Schubladen
 RU Сиденье для мастерской с выдвижными ящиками
 CZ Sedátko do dílny se zásuvkami
 HU Műhelyszék fiókkal
 RO Scaun atelier reglabil
 FR Siège d'atelier avec tiroirs
 IT Seggiolino da officina con cassetti
 ES Silla de taller con cajones
 CN 重型方形修车凳

380x380
x450-560
mm

3x

max 150 kg

360°
4x



YATO

YT-08795



1

EN Adjustable workshop seat
 PL Siedzisko warsztatowe teleskopowe
 DE Werkstatthocker, teleskopisch
 RU Сиденье для мастерской
 CZ Nastavitelné dílenské sedátko
 HU Teleszkópos műhely zsámoly
 RO Scaun atelier reglabil
 FR Tabouret d'atelier télescopique
 IT Sgabello da officina regolabile
 ES Taburete de taller neumático
 CN 修车凳

420x420
x410-550
mm

max 140 kg

360°
4x



YATO

YT-08793



1

EN Workshop creeper
 PL Leżanka warsztatowa
 DE Werkstatt-Liege
 RU Лежак ремонтный
 CZ Montážní lehátko
 HU Fekpad gurulós

RO Targă service
 FR Chariot de visite
 IT Lettino sottomacchina
 ES Camilla para mecánico
 CN 修车躺板

100 cm
6x



YATO

YT-0880



1

EN Workshop creeper
 PL Leżanka warsztatowa
 DE Werkstatt-Liege
 RU Лежак ремонтный
 CZ Montážní lehátko
 HU Fekpad gurulós

RO Targă service
 FR Chariot de visite
 IT Lettino sottomacchina
 ES Camilla para mecánico
 CN 修车躺板

91 cm
120 kg
150 kg
6x



YATO

YT-08802



1

EN Kneeling mat
 PL Mata pod kolana
 DE Kniematte
 RU Подставка для колен
 CZ Podložka pod kolena
 HU Térdalát
 RO Covoraş pt. genunchi
 FR Tapis de protection des genoux
 IT Tappetino per ginocchia
 ES Alfombrilla para las rodillas
 CN 跪垫

210x450 mm
30 mm
EPE



YATO

YT-08280



40

EN Workshop mat set
 PL Zestaw mat warsztatowych
 DE Werkstatmatten
 RU Пенные коврики для мастерской
 CZ Pénové podložky do dílny
 HU Hab garázs szőnyegeg
 RO Pres pt. atelier
 FR Jeu de tapis antidérapants
 IT Set di stuoie per officina
 ES Baldosas para taller
 CN 地垫

6 PCS
60x60 cm
max 12 mm
EVA

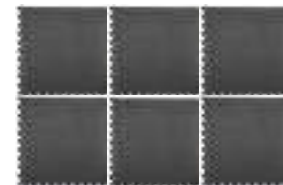

YATO

YT-08780



6

EN Automotive circuit tester
PL Wskaźnik elektryczny samochodowy
DE KFZ Prüflampe

RU Пробник напряжения автомобильный
CZ Zkoušečka napětí autoelektrikářská
HU Autóvillamosági teszter

RO Tester pt. circuite auto
FR Testeur de tension de voiture
IT Testler elettrico per auto

ES Indicador eléctrico de coche
CN 汽车测电笔



6-24V
90cm



6-12V
90cm

3-48V

2.7m

LED
DISPLAY
WYSWIETLACZ



YATO
YT-2865 25/250

YATO
YT-2866 10/100

YATO
YT-2867 25/100

EN Cloth cable wrap tape
PL Taśma parziana do wiązek kabli
DE Gevebeband für Kabelbäume
RU Лента хлопцевая для кабельных пучков
CZ Pletěná páska do kabelových svazků
HU Poliészter kábeltöteg szalag
RO Banda panza pt. izolat cabluri
FR Ruban adhésif textile
IT Nastro di tela per cablaggi
ES Cinchas para haces de cables
CN 绒布线束胶布



HOT MELT
GLUE
KLEJ
GORACO-
TOPLIWY

NONWOVEN
FABRIC
WŁOKNINA

°C
-40
+105



YATO	W [mm]	L [m]	± [mm]	
YT-81500	19	15	0.3	10/200
YT-81501	19	25	0.3	10/120

EN Number stamps
PL Znaczniki cyfrowe
DE Nummernstempel
RU Клейма цифровые
CZ Razidla číselná
HU Számbeütők
RO Poansoane cu cifre
FR Chiffres à frapper
IT Punzoni marcatori
ES Marcadores de números
CN 数字冲模



9
PCS

0-9
NUMBERS
NUMERY

HRC
50-55

1045
CARBON STEEL
STAL WĘGLOWA



EN Letter stamps
PL Znaczniki literowe
DE Buchstabenstempel
RU Клейма буквенные
CZ Razidla písmenová
HU Betűbeütők
RO Poansoane cu litere
FR Lettres à frapper
IT Punzoni marcatori
ES Marcadores de letras
CN 字母冲模



27
PCS

A-Z|&
LETTERS
LETTERY

HRC
50-55

1045
CARBON STEEL
STAL WĘGLOWA



YATO	Digit height / Wysokość cyfr [mm]	pcs / szt.	
YT-6854	6	9	20
YT-6855	8	9	18

YATO	Letter height / Wysokość liter [mm]	pcs / szt.	
YT-6862	6	27	12
YT-6863	8	27	8

EN Lambda sensor thread chaser
PL Zestaw do naprawy gwintów sondy lambda
DE Lambdasonde Gewinde Reparatur-Set
RU Набор для ремонта сорванной резьбы винтов
CZ Sada na opravu závitu lambda sondy
HU Menetjavító készlet lambda szondához
RO Dispozitiv pt. curatat filet sonda lambda
FR Set de réparation filetage de sonde lambda
IT Chiavi a bussola per sonda lambda
ES Cazador del hilo de rosca para sonda lambda
CN 火星塞丝攻组套

M12
x1.25
M18
x1.5

HRC
50

FOR OXYGEN
SENSOR
DO SONDY
LAMBDA



EN Oil pan thread repair set
PL Zestaw naprawy korków do miski olejowej
DE Reparatursatz für Verschlußstopfen von Ölwanen
RU Набор для ремонта масляных пробок
CZ Souprava na opravu vyrouštěcích šroubů olejových van
HU Olajteknő-csavar javítókészlet
RO Set pt. reparare dopuri baie de ulei
FR Kit réparation de bouchons de carter d'huile
IT Set per riparazione dei tappi della coppa del olio
ES Juego de reparación para los tapones del cárter de aceite
CN 螺纹修复组套

64
PCS

CrMo



M13	M13	13 mm	M17	M17	17 mm
5 pcs	5 pcs	10 pcs	5 pcs	5 pcs	10 pcs
M15	M15	15 mm	M20	M20	20 mm
5 pcs	5 pcs	10 pcs	5 pcs	5 pcs	10 pcs

YATO
YT-1756 12/96

YATO
YT-1757 5

- EN Oil pan thread repair set
- PL Zestaw naprawczy korków do miski olejowej
- DE Reparatursatz für Verschlussstopfen von Ölwanne
- RU Набор для ремонта масляных пробок
- CZ Souprava na opravu vroušťících sroubů olejových van
- HU Olajlejtető-csavar javítókészlet
- RO Set pt. reparare dopuri baie de ulei
- FR Carter d'huile fil kit de réparation
- IT Set per riparazione dei tappi della coppa del olio
- ES Juego de reparación para los tapones del cárter de aceite
- CN 螺纹修复组套



7
PCS

- EN Thread repair set
- PL Zestaw do naprawy gwintów
- DE Reparatursatz für Gewinde
- RU Набор для ремонта резьбы
- CZ Souprava na opravu závitů
- HU Menejavitó készlet
- RO Set pt. reparare filete
- FR Set d'helicoils
- IT Kit di riparazione per filettature
- ES Juego para reparar roscas
- CN 螺纹修复组套

88
PCS

HSS
4341

SS
STAINLESS STEEL
STAL NIERDZEWNA



YATO	Dimensions / Wymiary	
YT-1769	M6x1x10.8 mm, M8x1.25x10.8 mm, M10x1.5x13.5 mm	5/10

YATO	Thread size / Rozmiar gwintu	
YT-1751	M13x1.5 mm	10/40
YT-1752	M15x1.5 mm	10/40
YT-1753	M17x1.5 mm	10/40
YT-1754	M20x1.5 mm	10/40
YT-1755	M22x1.5 mm	10/40

- EN Thread repair set
- PL Zestaw do naprawy gwintów
- DE Reparatursatz für Gewinde
- RU Набор для ремонта резьбы
- CZ Souprava na opravu závitů
- HU Menejavitó készlet
- RO Set pt. reparare filete
- FR Set d'helicoils
- IT Kit di riparazione per filettature
- ES Juego para reparar roscas
- CN 螺纹修复组套

131
PCS

HSS
4341

SS
STAINLESS STEEL
STAL NIERDZEWNA

- EN Wire threads
- PL Wkłady spiralne do naprawy gwintów
- DE Spiraleinlagen für Gewindereparatur
- RU Метчики и сверла для ремонта резьбы
- CZ Spirálové vložky na opravu závitů
- HU Menejavitó betétek

- RO Insertii spirală pt. reparare filete
- FR Helicoil
- IT Inserti a spirale per riparazione
- ES Elementos espirales para reparar roscas
- CN 不锈钢螺纹套

SS
STAINLESS STEEL
STAL NIERDZEWNA



For YT-1763, YT-1769
Dla YT-1763, YT-1769

YATO	Dimensions / Wymiary	
YT-1763	M5x0.8x6.7 mm, M6x1x10.8 mm, M8x1.25x10.8 mm, M10x1.5x13.5 mm, M12x1.75x16.3 mm	5/10

YATO	Dimensions / Wymiary	pcs / szt.	
YT-1764	M5x0.8x6.7 mm	20	50/250
YT-1765	M6x1x10.8 mm	20	50/250
YT-1766	M8x1.25x10.8 mm	20	50/200
YT-1767	M10x1.5x13.5 mm	15	25/100
YT-1768	M12x1.75x16.3 mm	10	25/100

- EN Thread repair set
- PL Zestaw do naprawy gwintów
- DE Reparatursatz für Gewinde
- RU Набор для ремонта резьбы
- CZ Souprava na opravu závitů
- HU Menejavitó készlet
- RO Set pt. reparare filete
- FR Set d'helicoils
- IT Kit di riparazione per filettature
- ES Juego para reparar roscas
- CN 螺纹修复工具组套



HSS
4241
4341

SS
STAINLESS STEEL
STAL NIERDZEWNA

- EN Spark plug thread repair set
- PL Zestaw naprawczy gwintu świecy zapłonowej
- DE Reparatursatz für Zündkerzengewinde
- RU Набор для восстановления резьбы свечи зажигания
- CZ Sada pro opravu závitů zážehové svíčky
- HU Gyújtógyertya menajavitó készlet
- RO Set reparat filet bujie
- FR Kit de réparation du filetage de bougie d'allumage
- IT Kit di riparazione per cavi di candele di accensione
- ES Kit de reparación para rosca de bujía de encendido
- CN 火花塞螺纹修复工具

16
PCS

M14
x1.25

11.5
mm

M16
x1.25

17.5
mm

YATO	Thread size / Rozmiar gwintu	pcs / szt.	
YT-17631	M5x0.8 mm	30	20/40
YT-17632	M6x1.0 mm	30	20/40
YT-17633	M8x1.25 mm	30	20/40
YT-17634	M10x1.5 mm	30	20/40
YT-17635	M12x1.75 mm	30	20/40



YATO	
YT-17580	20

- EN Spark plug thread repair set
PL Zestaw naprawczy gwintu świecy zapłonowej
DE Reparatursatz für Zündkerzengewinde
RU Набор для восстановления резьбы свечи зажигания
CZ Sada pro opravu závitů zážehové svíčky
HU Gyújtógyertyya menetjavító készlet
RO Set reparat filet bujie
FR Kit de réparation du filetage de bougie d'allumage
IT Kit di riparazione per cavi di candele di accensione
ES Kit de reparación para rosca de bujías de encendido
CN 火花塞螺纹修复工具

25
PCS

M14
x1.25

10
mm

15
mm

3/8"
9.5mm

HSS



YATO
YT-17581 10

- EN Internal spark plug thread chaser set
PL Zestaw gwintowników do świec
DE Nachschneider-Set für Zündkerzen-Gewinde
RU Набор метчиков резьбы под свечи накалвания
CZ Sada na opravu závitů zapalovacích svíček
HU Gyújtógyertyya menetjavító készlet
RO Set de curățare filet bujii interne
FR Set de tarauds pour filetage de bougie d'allumage
IT Kit di maschi per candele
ES Juego de machos rosca para bujías
CN 火花塞螺纹修复工具

7
PCS

CrMo

LONG
DLUGIE



M8 x 1.0 x 115 mm, M10 x 1.0 x 115 mm, M12 x 1.25 x 135 mm, M12 x 1.25 x 260 mm, M14 x 1.25 x 130 mm, M14 x 1.25 x 260 mm, M18 x 1.5 x 80 mm

YATO
YT-17708 10

- EN Brake calliper guide bolt repair tool set
PL Zestaw naprawczy prowadnic zacisków hamulcowych
DE Reparatursatz für Bremssattelführungen
RU Набор для ремонта направляющих тормозного суппорта
CZ Sada pro opravu vodítek brzdových třmenů
HU Féknyereg vezetőpersely szerelő készlet
RO Set de instrumente pt. repararea suruburilor ghidajului etrierului
FR Kit de réparation pour les guides d'étrier de frein
IT Kit di riparazione per guide di scorrimento delle pinze di freni
ES Kit de reparación para guías de mordazas de freno
CN 刹车卡钳螺栓修复工具

12
PCS

M10
x1.25

HSS

VAG

FORD
OPEL



Ford, Opel, VAG

YATO
YT-17588 20

- EN Spark plug thread chaser
PL Zestaw do naprawy gwintów świec
DE Stopfengewinde-Reparaturset
RU Набор для ремонта резьбы свечей
CZ Sada na opravu závitů svíček
HU Gyertyamenet javító készlet
RO Curatorul filet bujie
FR Kit de réparation pour filet de bougies d'allumage
IT Kit per riparazione di filettature di candele
ES Kit de reparación de roscas de bujía
CN 火星塞螺纹攻套

2
PCS

M10x1.0
M12x1.25
M14x1.5
M18x1.5

21
mm

HRC
50



YATO
YT-17697 16/64

- EN Glow plug threads repair kit
PL Zestaw naprawczy gwintów świec żarowych
DE Reparatursatz für Glühkerzengewinde
RU Набор для ремонта резьбы свечи накалвания
CZ Sada pro opravu závitů žhavicích svíček
HU Izzítógyertyya menetjavító készlet
RO Set de reparare filete bujii incandescente
FR Kit de réparation pour les filetages des bougies de préchauffage
IT Kit di riparazione per filettature di candele di accensione
ES Kit de reparación para roscas de bujías de calentamiento
CN 火花塞螺纹修复工具

33
PCS

M8
x1.0

M10
x1.0

M10
x1.25

M12
x1.25



Included / W zestawie: reamers / rozwiertaki: M8x1.0, M10x1.0, M10x1.25, M12x1.0, M12x1.25, M14x1.25; threaded sleeves / tuleje gwintowane: M8x1.0, M10x1.0, M10x1.25, M12x1.25 (x5 PCS); screws / śruby prowadzące (3 PCS); taps for rethreading the original thread / gwintowniki do poprawy gwintów (2 PCS); handle / uchwyty

YATO
YT-17710 10

- EN Brake thread repair set
PL Zestaw naprawczy gwintów zacisku hamulcowego
DE Gewindereparatursatz für Bremssattel
RU Комплект для ремонта резьбы суппорта тормоза
CZ Sada na opravu závitů brzdového třmenů
HU Féknyereg menetjavító készlet
RO Set reparat cablu de frana
FR Kit de réparation pour filetages d'étriers de frein
IT Kit di riparazione per filettature di pinze di freni
ES Kit de reparación de roscas para pinzas de freno
CN 刹车螺纹修复工具

16
PCS

M9
x1.25

HSS



Ford, Opel, VAG

YATO
YT-17700 10

EN Rethread tool kit set
 PL Zestaw do naprawy gwintów śrub i nakrętek
 DE Gewindereparatursatz für Schrauben und Mutter
 RU Комплект для ремонта резьбы на винтах и гайках
 CZ Sada pro opravu závitů na šroubech a maticích
 HU Csavarok és anyák menetének javítására szolgáló készlet

RO Kit pt. reparat filete
 FR Kit de réparation de filetage
 IT Kit di riparazione delle filettature viti e dadi
 ES Kit de reparación de roscas en tornillos y tuercas
 CN 螺纹修复工具组套

15
PCS



EN Axle spindle rethreading set
 PL Zestaw do naprawy gwintów półosi
 DE Gewindereparatur Set Antriebswelle
 RU Набор для восстановления резьбы оси шруса
 CZ Souprava k opravě závitů hnacích hřídelí
 HU Reszes menetjavító készlet főtengelyekhez

RO Trusa pt. reparat filetele la planetare
 FR Kit réparation filetage cardan
 IT Kit di ripristino di filetti dei semiassi
 ES Kit de herramienta de la reparación
 CN 传动轴螺杆修复组套

8
PCS

5/4"
32mm



Metric thread file pitches / Płniki do naprawy gwintów: 0.75, 1.0, 1.25, 1.5, 1.75, 2.0, 2.5, 3.0 mm;
 Rethreader dies / Narzynki: 6x1.00, 8x1.25, 10x1.25, 10x1.50, 12x1.25, 12x1.50, 12x1.75 mm;
 Rethreader taps / Gwintowniki: 6x1.00, 8x1.25, 10x1.25, 10x1.50, 12x1.25, 12x1.50, 12x1.75 mm

YATO **YT-17705** 20



M24x1.5; M24x2.0; M22x1.0; M22x1.5; M20x1.25; M20x1.5; 3/4x20 UNEF; 13/16x20 UNEF

YATO **YT-17695** 10

EN Injector clamping bolt thread repair kit
 PL Zestaw naprawczy do gwintów śrub mocujących wtryskiwacze
 DE Gewinde-Reparatur Satz für Injektor-Befestigungsschraube
 RU Набор для ремонта резьбы крепежных винтов форсунок
 CZ Sada na opravu závitů upevňovacích šroubů vstřikovače
 HU Menetjavító készlet befecskendezők rögzítéscsavarjaihoz
 RO Kit de reparare a filetelui șurubului de strângere a injectorului
 FR Kit de réparation filetage pour vis de fixation injecteur
 IT Kit per riparazione di filettature delle viti di fissaggio per iniettori
 ES Kit de reparación de roscas de tornillos de fijación de inyectores
 CN 喷油器夹紧螺栓螺纹修复

10
PCS



M6X1



EN Pressure gauge
 PL Wskaźnik ciśnienia
 DE Druckanzeige
 RU Манометр
 CZ Tlakomer
 HU Nyomásmérő



0-15
bar

140
mm



0-220
psi

FOR TRUCKS
DO AUT
CIEŻAROWYCH



YATO **YT-06036** 10

YATO **YT-24301** 25/100

EN Foot pump with gauge
 PL Pompka nożna z manometrem
 DE Fusspumpe
 RU Насос ножный с манометром
 CZ Nožní pumpa s manometrem
 HU Lábpumpa nyomásmérővel
 RO Pompă de picior cu manometru
 FR Pompe à pied avec manomètre
 IT Pompa a pedale con manometro
 ES Bomba de pierna con manómetro
 CN 打气筒

0.7
MPa
(max.)



YATO **YT-7349** 10

EN Foot pump with gauge
 PL Pompka nożna z manometrem
 DE Fusspumpe
 RU Насос ножный с манометром
 CZ Nožní pumpa s manometrem
 HU Lábpumpa nyomásmérővel
 RO Pompă de picior cu manometru
 FR Pompe à pied avec manomètre
 IT Pompa a pedale con manometro
 ES Bomba de pierna con manómetro
 CN 带压力表双管打气筒

0.7
MPa
(max.)

TWIN
PISTON
PODWÓJNY
TŁOK



YATO **YT-7350** 10

- EN Hand pump with manometer
- PL Pompka słupkowa z manometrem
- DE Hand-Luftpumpe mit Manometer
- RU Насос ручной с манометром
- CZ Pumpa s manometrem
- HU Kézi pumpa manométerrel
- RO Pompa de mana cu manometru
- FR Pompe manuelle avec manomètre
- IT Pompa verticale con manometro
- ES Bomba de barrote con manometro
- CN 直立式打气筒 (機械錶)



- 0.8 MPa (max.)
- 0-120 psi
- 65 cm
- UNIVERSAL DOUBLE HEAD
UNIVERSALNA GŁOWICA
PODWÓJNA





YATO  [V d.c.] 
YT-73521 3

- EN Rechargeable air compressor
- PL Kompressor bezprzewodowy
- DE Kabelloser Kompressor
- RU Беспроводной компрессор
- CZ Bezdrátový kompresor
- HU Vezeték nélküli kompresszor
- RO Compressor de aer reîncărcabil
- FR Compresseur sans-fil
- IT Compressore senza fili
- ES Compressor inalámbrico
- CN 充气泵

- 120 W
- 1.0 MPa
- 25 l/min
- 11.1V 2200mAh Li-Ion
- 4h
- 20min
- USB CHARGING LADOWANIE
- 25 cm
- LED LIGHTING OSWIETLENIE



Setups / Ustawienia: 3-150 psi, 0.2-10.3 bar, 20-995 kPa, 0.2-10.5 kg/cm²
YATO  [V d.c.] 
YT-82950 11.1 (3.7 x3) 12

- EN Car air compressor
- PL Kompressor samochodowy
- DE Auto-Kompressor
- RU Автомобильный компрессор
- CZ Automobilový kompresor
- HU Autókompresszor
- RO Compressor auto
- FR Compresseur de voiture
- IT Compressore d'auto
- ES Compressor de coche
- CN 车用充气泵



- 120 W
- 1.0 MPa
- 12V
- 25 l/min
- LCD
- 60 cm
- 3 m
- LED





YATO  [W] 
YT-73470 120 12

- EN Car air compressor
- PL Kompressor samochodowy
- DE Auto-Kompressor
- RU Автомобильный компрессор
- CZ Automobilový kompresor
- HU Autókompresszor
- RO Compressor auto
- FR Compresseur de voiture
- IT Compressore d'auto
- ES Compressor de coche
- CN 车用充气泵

- 180 W
- 1.0 MPa
- 12V
- 40 l/min
- 1 m
- 3 m



YATO  [W] 
YT-73460 180 8

- EN Car air compressor
- PL Kompressor samochodowy
- DE Auto-Kompressor
- RU Автомобильный компрессор
- CZ Automobilový kompresor
- HU Autókompresszor
- RO Compressor auto
- FR Compresseur de voiture
- IT Compressore d'auto
- ES Compressor de coche
- CN 车用充气泵

- 250 W
- 1.0 MPa
- 12V
- 60 l/min
- 5 m
- 3 m



YATO  [W] 
YT-73462 250 4

EN Air compressor
 PL Kompressor olejowy
 DE Ölkompressor
 RU Масляный компрессор
 CZ Olejový kompresor
 HU Olajos kompresszor
 RO Compresor
 FR Compresseur à pistons
 IT Compresore d'aria
 ES Compresor de pistón
 CN 直连式空压机

230-240V~
50Hz

1.5kW
2KM

1500
W

2850
min⁻¹

0.8
MPa

200
l/min

24L



$L_{pA} = 74,2 \pm 3,0$ dB; $L_{wA} = 93,7 \pm 2,23$ dB

YATO 	[W]	
YT-23300	1500	1

EN Air compressor
 PL Kompressor olejowy
 DE Ölkompressor
 RU Масляный компрессор
 CZ Olejový kompresor
 HU Olajos kompresszor
 RO Compresor
 FR Compresseur à pistons
 IT Compresore ad olio
 ES Compresor de pistón
 CN 直连式空压机

230-240V~
50Hz

1.5kW
2KM

1500
W

2850
min⁻¹

0.8
MPa

200
l/min

50L



$L_{pA} = 74,2 \pm 3,0$ dB; $L_{wA} = 93,7 \pm 2,23$ dB

YATO 	[W]	
YT-23305	1500	1

EN Air compressor
 PL Kompressor olejowy
 DE Ölkompressor
 RU Масляный компрессор
 CZ Olejový kompresor
 HU Olajos kompresszor
 RO Compresor
 FR Compresseur à pistons
 IT Compresore ad olio
 ES Compresor de pistón
 CN 直连式空压机

230V~
50Hz

2.2kW
3KM

2200
W

1100
min⁻¹

2x 

1.0
MPa

360
l/min

100L



$L_{pA} = 74,7 \pm 3,0$ dB; $L_{wA} = 93,8 \pm 2,28$ dB

YATO 	[W]	
YT-23310	2200	1

EN Air compressor
 PL Kompressor olejowy
 DE Ölkompressor
 RU Масляный компрессор
 CZ Olejový kompresor
 HU Olajos kompresszor
 RO Compresor
 FR Compresseur à pistons
 IT Compresore d'aria
 ES Compresor de pistón
 CN 直连式空压机

230V~
50Hz

2.2kW
3KM

2200
W

1100
min⁻¹

2x 

1.0
MPa

360
l/min

200L





$L_{pA} = 74,7 \pm 3,0$ dB; $L_{wA} = 93,8 \pm 2,28$ dB



YATO 	[W]	
YT-23320	2200	1

- EN Air wedge
- PL Poduszka montażowa
- DE Luft Keil
- RU Монтажная подушка
- CZ Rozpínací montážní polštář
- HU Emelőpárna
- RO Perna de aer
- FR Coussin élévateur
- IT Cuscino di montaggio
- ES Cojines elevadores
- CN 门窗安装气囊



50 mm ↑ TPU 



YATO 	Size / Rozmiar [mm]	
YT-67380	150x160	24
YT-67381	165x150	48
YT-67382	190x110	48
YT-67383	270x130	48

- EN Air pump wedge set
- PL Zestaw poduszek montażowych
- DE Montagekissen-Set
- RU Набор монтажных подушек
- CZ Rozpínací polštářky
- HU Szerelőpárna készlet
- RO Set perne de aer
- FR Cousins d'air pour soulever
- IT Set di cuscinetti gonfiabili per montaggio porte e finestre
- ES Juego de bolsas de cuña de aire
- CN 门窗安装气囊



3 PCS 165x150 mm 190x110 mm 270x130 mm

50 mm ↑ max 135 kg TPU 





YATO 	YT-67385	
		48

- EN Tire rack
- PL Stojak na kola
- DE Reifenständer
- RU Стойка для колес
- CZ Stojan na pneumatiky
- HU Keréktartó állvány
- RO Suport pt. anvelope
- FR Support pour roues
- IT Supporto verticale per pneumatici
- ES Soporte para llantas
- CN 轮胎架





max 225 mm max 100 kg (4x25) 

YATO 	YT-55690	
		1

- EN Mobile tire rack
- PL Mobilny stojak na kola
- DE Mobiler Reifenständer
- RU Мобильная стойка для хранения шин
- CZ Pojízdný stojan na pneumatiky
- HU Mobil keréktartó állvány
- RO Suport mobil pt. anvelope
- FR Support pour roues mobile
- IT Supporto verticale mobile per pneumatici
- ES Soporte para llantas móvil
- CN 移动式轮胎挂架





max 225 mm max 100 kg (4x25) 4x BRAKE HAMULEC 360° 4x 

YATO 	YT-55691	
		6

- EN Oil jug
- PL Nalewak warsztatowy
- DE Ölkanne
- RU Лейка пластиковая с крышкой
- CZ Odměrka plastová - konev
- HU Olajbetöltő kanna
- RO Recipient ulei
- FR Broc verseur avec couvercle
- IT Serbatoio
- ES Jarra con pitorro de aceite
- CN 油壶



PE FOR AUTOMOTIVE FLUIDS DO PLYNŃW EKSP. FŁYDŃWYCH FLEXIBLE SPOUT ELASTYCZNY LEJEK 

YATO 		
YT-06980	1	48
YT-06983	3	40
YT-06985	5	16

- EN Oil jug
- PL Nalewak warsztatowy
- DE Ölkanne
- RU Лейка пластиковая с крышкой
- CZ Odměrka plastová - konev
- HU Olajbetöltő kanna
- RO Recipient ulei
- FR Broc verseur avec couvercle
- IT Serbatoio
- ES Jarra con pitorro de aceite
- CN 油壶



10 L PE FOR AUTOMOTIVE FLUIDS DO PLYNŃW EKSP. FŁYDŃWYCH 

YATO 	YT-06987	
	10	8

EN Funnel
PL Lejek
DE Trichter
RU Воронка гибкая
CZ Nálevka
HU Kétrészes tölcser

RO Pálnie
FR Entonnoir
IT Imbuto
ES Embudo
CN 漏斗

∅ 135 mm
PP
✕



YATO	∅ [mm]	
YT-0694	135	192

EN Long funnel
PL Lejek długi
DE Trichter
RU Воронка гибкая
CZ Nálevka
HU Kétrészes tölcser
RO Pálnie
FR Entonnoir
IT Imbuto
ES Embudo
CN 漏斗

∅ 120 mm
455 mm
PP
✕



YATO	L [mm]	∅ [mm]	
YT-0693	455	120	48

EN Operating fluids funnel
PL Lejek do płynów eksploatacyjnych
DE Trichter
RU Воронка гибкая
CZ Nálevka
HU Kétrészes tölcser

RO Pálnie
FR Entonnoir
IT Imbuto
ES Embudo
CN 漏斗

∅ 100 mm
PP
✕



YATO	∅ [mm]	
YT-0695	100	180

EN Operating fluids funnel
PL Lejek do płynów eksploatacyjnych
DE Trichter
RU Воронка гибкая
CZ Nálevka
HU Kétrészes tölcser

RO Pálnie
FR Entonnoir
IT Imbuto
ES Embudo
CN 漏斗

∅ 240 mm
PP
✕



YATO	∅ [mm]	
YT-0696	240	48

EN Fuel and oil funnel
PL Lejek do paliwa i oleju
DE Trichter
RU Воронка гибкая
CZ Nálevka
HU Kétrészes tölcser
RO Pálnie
FR Entonnoir
IT Imbuto
ES Embudo
CN 漏斗

∅ 150 mm
PP
✕



YATO	∅ [mm]	
YT-0692	150	30

EN Oil funnel
PL Lejek do oleju
DE Trichter
RU Воронка гибкая
CZ Nálevka
HU Kétrészes tölcser

RO Pálnie
FR Entonnoir
IT Imbuto
ES Embudo
CN 漏斗

∅ 280 mm
PP
✕



YATO	∅ [mm]	
YT-0697	280	48

EN Oil funnel with handle
PL Lejek specjalny z uchwytem
DE Spezialtrichter mit Griff
RU Специальная воронка с ручкой
CZ Speciální trychtýř s rukojetí
HU Speciális tölcser fogantyúval
RO Pálnie pt. ulei cu maner
FR Entonnoir spécial avec poignée
IT Imbuto speciale con impugnatura
ES Embudo especial con soporte
CN 漏斗



∅ 20/125 mm
NYLON
PP

YATO	∅ [mm]	
YT-06972	20, 125	10/20

EN Manual car oil pump
PL Odsysarka ręczna do oleju
DE Manuelle Öl-Absaugpumpe
RU Ручной насос для откачки масла
CZ Ruční vakuová odsávačka oleje a kapalín
HU Kézi pumpás olajleszívó
RO Pompă de aspirație pt. aspiratia uleiului
FR Pompe à vide pour aspiration d'huile
IT Aspiratore manuale per olio
ES Bomba de vacío para aspiración de aceite
CN 手动抽油机



9L
3
SUCTION PROBES
BONDY SPACE
FOR OIL
DO
OLEJU

YATO	
YT-07087	4

EN Waste oil storage container
PL Pojemnik zlewowy do oleju
DE Öl-Auffangkanister
RU Емкость для слива отработанного масла
CZ Nádobna na použitý olej
HU Fáradt olaj gyűjtő

RO Canistra colectare ulei
FR Bidon de collecte d'huile
IT Tanica per cambio olio
ES Bidón cambio de aceite
CN 积油壶



600x330
x110
mm

8L

PE



EN Oil drainer
PL Zlewarka do oleju
DE Öleinfüllanlage
RU Устройство для слива масла
CZ Olejová nádrž s odsáváním
HU Fáradtolaj leszívó
RO Dispozitiv pt. schimbare ulei
FR Récupérateur d'huile
IT Scolapiatti dell'olio
ES Decantador para aceite
CN 泄油器

20L

∅ 42
cm

75-155
cm

PE



YATO	[l]	[mm]	
YT-06995	8	600x330x110	4

EN Oil drain pan
PL Miska do oleju
DE Ölwanne
RU Поддон для слива масла
CZ Miska na olej
HU Fáradt olaj felfogó edény

RO Vas pt. ulei
FR Bac de récupération d'huile
IT Vaschetta per cambio olio
ES Recipiente para drenaje de aceite
CN 接油盆



7L

PP



YATO	[l]	∅ [mm]	
YT-0699	7	370	24

EN Oil drain pan
PL Miska do oleju
DE Ölwanne
RU Поддон для слива масла
CZ Miska na olej
HU Fáradt olaj felfogó edény

RO Vas pt. ulei
FR Bac de récupération d'huile
IT Vaschetta per cambio olio
ES Recipiente para drenaje de aceite
CN 接油盆



PE



YATO	[l]	∅ [mm]	
YT-0716	10	370	6
YT-0717	15	420	4

EN Farm jack
PL Podnośnik farmerski
DE Bauernhof-Jack
RU Домкрат механический реечный
CZ Zvedák farm jack
HU Hi-jack fogaslécés off-road emelő
RO Cric mecanic tip off-road
FR Vérins mécaniques commerciales
IT Farm jack - sollevatore di auto
ES Elevación mecánicas comerciales
CN 农夫顶

3t

690
115
mm



YATO	[t]	Lifting range / Zakres podnoszenia [mm]	
YT-17260	3	115-690	1

EN Farm jack
PL Podnośnik farmerski
DE Bauernhof-Jack
RU Домкрат механический реечный
CZ Zvedák farm jack
HU Hi-jack fogaslécés off-road emelő
RO Cric mecanic tip off-road
FR Vérins mécaniques commerciales
IT Farm jack - sollevatore di auto
ES Elevación mecánicas comerciales
CN 农夫顶

3t

1060
125
mm



YATO	[t]	Lifting range / Zakres podnoszenia [mm]	
YT-17261	3	125-1060	1

EN Farm jack
PL Podnośnik farmerski
DE Bauernhof-Jack
RU Домкрат механический реечный
CZ Zvedák farm jack
HU Hi-jack fogaslécés off-road emelő
RO Cric mecanic tip off-road
FR Vérins mécaniques commerciales
IT Farm jack - sollevatore di auto
ES Elevación mecánicas comerciales
CN 农夫顶

3t



1320
125
mm



YATO	[t]	Lifting range / Zakres podnoszenia [mm]	
YT-17262	3	125-1320	1

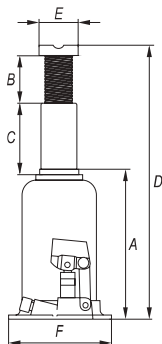

EN Hydraulic bottle jack
 PL Podnośnik hydrauliczny słupkowy
 DE Hydraulischer Stempelwagenheber
 RU Домкрат гидравлический
 CZ Pístový zvedák hydraulický
 HU Hidraulikus emelő
 RO Cric hidraulic
 FR Cric hydraulique bouteille
 IT Cric idraulico a bottiglia
 ES Gato hidráulico de botella
 CN 立式液压千斤顶



YATO 	[t]	A [mm]	B [mm]	C [mm]	D [mm]	E [mm]	F [mm]	
YT-17000	2	181	48	116	345	25	88x92	6
YT-17001	3	194	60	120	374	27	92x100	6
YT-17002	5	216	60	137	413	29	96x110	4
YT-17003	8	230	80	147	457	32	103x118	2
YT-17004	10	230	80	150	460	36	110x123	2
YT-17005	12	230	80	155	465	40	116x134	2
YT-17006	15	230	82	150	462	43	140x134	2
YT-17007	20	242	60	150	452	45	144x150	2
YT-17008	32	285	-	180	465	69	190x152	1
YT-17009	50	300	-	180	480	83	218x176	1

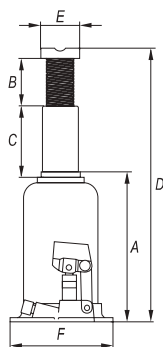

EN Hydraulic bottle jack
 PL Podnośnik hydrauliczny słupkowy
 DE Hydraulischer Stempelwagenheber
 RU Домкрат гидравлический
 CZ Pístový zvedák hydraulický
 HU Hidraulikus emelő
 RO Cric hidraulic
 FR Cric hydraulique bouteille
 IT Cric idraulico a bottiglia
 ES Gato hidráulico de botella
 CN 立式液压千斤顶



YATO 	[t]	A [mm]	B [mm]	C [mm]	D [mm]	E [mm]	F [mm]	
YT-17015	2	172	88	112	372	28	103x105	4
YT-1702	5	218	110	146	474	40	110x112	5
YT-17025	8	220	115	153	488	45	124x127.5	2
YT-1704	10	220	115	148	483	48	124x127.5	3
YT-17045	12	230	115	160	505	45	130x136	2
YT-1706	15	228	113	154	508	56	140x142	2
YT-1707	20	241	115	165	521	60	165x161	2
YT-17075	25	240	110	160	510	65	186x174	1
YT-1709	30	244	108	140	510	65	186x174	1

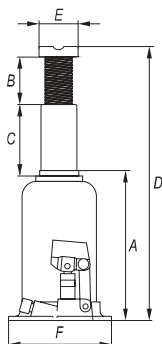

EN Two-piston hydraulic bottle jack
 PL Podnośnik hydrauliczny słupkowy dwutokowy
 DE Hydraulischer Stempelwagenheber
 RU Домкрат гидравлический
 CZ Pístový zvedák hydraulický
 HU Hidraulikus emelő
 RO Cric hidraulic
 FR Cric hydraulique bouteille
 IT Cric idraulico a bottiglia
 ES Gato hidráulico de botella
 CN 液压双级千斤顶

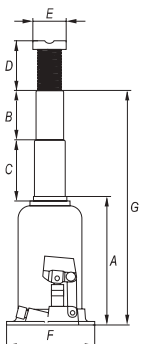

YATO 	[t]	A [mm]	B [mm]	C [mm]	D [mm]	E [mm]	F [mm]	
YT-1711	5	230	146	138	500	41	130x136	2
YT-1713	10	125	63	38	215	47	160x165	2

EN Two-piston hydraulic bottle jack
 PL Podnośnik hydrauliczny słupkowy dwutokowy
 DE Hydraulischer Stempelwagenheber
 RU Домкрат гидравлический
 CZ Pístový zvedák hydraulický
 HU Hidraulikus emelő
 RO Cric hidraulic
 FR Cric hydraulique bouteille
 IT Cric idraulico a bottiglia
 ES Gato hidráulico de botella
 CN 液压双级千斤顶



YATO 	[t]	A [mm]	B [mm]	C [mm]	D [mm]	E [mm]	F [mm]	G [mm]	
YT-1714	10	210	120	118	78	48	165x161	520	1
YT-1715	12	235	138	128	98	56	186x174.5	590	1

EN Hydraulic floor jack
PL Podnośnik hydrauliczny
DE Hydraulischer Rangierwagenheber
RU Домкрат гидравлический
CZ Pístový zvedák hydraulický
HU Krokodíl emelő
RO Cric tip crocodil
FR Cric hydraulique
IT Sollevatore idraulico
ES Gato hidráulico
CN 卧式液压千斤顶

2t
359
89
mm



YATO 	[1]	
YT-1720	2	1

EN Hydraulic floor jack
PL Podnośnik hydrauliczny
DE Hydraulischer Rangierwagenheber
RU Домкрат гидравлический
CZ Pístový zvedák hydraulický
HU Krokodíl emelő
RO Cric tip crocodil
FR Cric hydraulique
IT Sollevatore idraulico
ES Gato hidráulico
CN 卧式液压千斤顶

2.5t
508
80
mm
DUAL PUMP
PODWÓJNA
POMPA
QUICK LIFT
SZYBKE
PODNOSENIÉ
LOW PROFILE
NISKI
PROFIL



YATO 	[1]	
YT-17207	2.5	1

EN Hydraulic floor jack
PL Podnośnik hydrauliczny
DE Hydraulischer Rangierwagenheber
RU Домкрат гидравлический
CZ Pístový zvedák hydraulický
HU Krokodíl emelő
RO Cric tip crocodil
FR Cric hydraulique
IT Sollevatore idraulico
ES Gato hidráulico
CN 卧式液压千斤顶

3t
465
130
mm
LOW PROFILE
NISKI
PROFIL



YATO 	[1]	
YT-17211	3	1

EN Hydraulic floor jack
PL Podnośnik hydrauliczny
DE Hydraulischer Rangierwagenheber
RU Домкрат гидравлический
CZ Pístový zvedák hydraulický
HU Krokodíl emelő
RO Cric tip crocodil
FR Cric hydraulique
IT Sollevatore idraulico
ES Gato hidráulico
CN 卧式液压千斤顶



YATO 	[1]	
YT-17214	3	1

EN Hydraulic floor jack
PL Podnośnik hydrauliczny
DE Hydraulischer Rangierwagenheber
RU Домкрат гидравлический
HU Krokodíl emelő
RO Cric tip crocodil
FR Cric hydraulique
IT Sollevatore idraulico
ES Gato hidráulico
CN 卧式液压千斤顶

2.5t
465
100
mm
DUAL PUMP
PODWÓJNA
POMPA
QUICK LIFT
SZYBKE
PODNOSENIÉ
AI



ULTRA LIGHT 

YATO 	[1]	
YT-17205	2.5	1

EN Hydraulic floor jack
PL Podnośnik hydrauliczny
DE Hydraulischer Rangierwagenheber
RU Домкрат гидравлический
HU Krokodíl emelő
RO Cric tip crocodil
FR Cric hydraulique
IT Sollevatore idraulico
ES Gato hidráulico
CN 卧式液压千斤顶

2.5t
455
87
mm





YATO 	[1]	
YT-1721	2.5	1

EN Hydraulic floor jack
PL Podnośnik hydrauliczny
DE Hydraulischer Rangierwagenheber
RU Домкрат гидравлический
CZ Pístový zvedák hydraulický
HU Krokodíl emelő
RO Cric tip crocodil
FR Cric hydraulique
IT Sollevatore idraulico
ES Gato hidráulico
CN 卧式液压千斤顶

3t
500
145
mm



YATO 	[1]	
YT-17213	3	1

3t
465
130
mm
DUAL PUMP
PODWÓJNA
POMPA
QUICK LIFT
SZYBKE
PODNOSENIÉ
LOW PROFILE
NISKI
PROFIL

- EN Vehicle ramp
- PL Najazd samochodowy
- DE Auffahrrampe
- RU Мни эстакада для автомобиля
- CZ Nájezd na auto
- HU Felhajtó rámpa
- RO Rampa auto
- FR Rampe pour voiture
- IT Rampa per veicoli
- ES Rampa para coches
- CN 运送顶

1 PC **1000** kg **815x305x200** mm



- EN Wheel chock
- PL Klin pod kola
- DE Unterlegkeil
- RU Упор противооткатный
- CZ Klín pod kola
- HU Kerékkilátaszó ék
- RO Opritor roata
- FR Cale de roue
- IT Cuneo per ruote
- ES Calzo para ruedas
- CN 轮挡

220x110x80 mm **max** **2500** kg

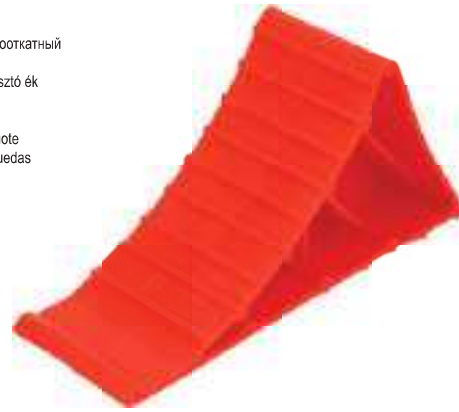

PP

YATO	Dimensions / Wymiary [mm]	
YT-55670	815x305x200	10

YATO	Dimensions / Wymiary [mm]	
YT-55675	220x110x80	48

- EN Jack stand
- PL Podstawka pod samochód
- DE Unterstellbock
- RU Подставка автомобильная
- CZ Podstavec pod auto
- HU Gépkocsi alátét
- RO Capra auto
- FR Chandelle de voiture
- IT Cavalletto auto
- ES Caballete para auto
- CN 汽车安全支架

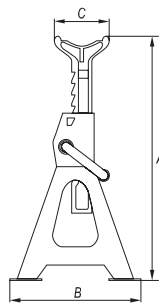

YATO	[t]	A [mm]	B [mm]	C [mm]	pcs / szt.	
YT-17310	2	265-415	190x165	77x40	2	1
YT-17311	3	280-420	182x201	85x29	2	1
YT-17312	6	388-580	258x285	100x29	2	1

- EN Porta power repair kit
- PL Rozpierał hydrauliczny
- DE Hydraulischer Richt und Ausbeulsatz
- RU Гидравлическая распорная стойка в наборе
- CZ Hydraulický rozpěrák
- HU Hidraulikus bontó

- RO Trusa pompa hidraulica + accesorii
- FR Porta puissance hydraulique
- IT Martinetto idraulico
- ES Gato carrocerro hidráulico
- CN 分离顶

4t

- EN Porta power repair kit
- PL Rozpierał hydrauliczny
- DE Hydraulischer Richt und Ausbeulsatz
- RU Гидравлическая распорная стойка в наборе
- CZ Hydraulický rozpěrák
- HU Hidraulikus bontó

- RO Trusa pompa hidraulica + accesorii
- FR Porta puissance hydraulique
- IT Martinetto idraulico
- ES Gato carrocerro hidráulico
- CN 分离顶

10t



Included: hydraulic cylinder 270x395 mm, expander jaws 0.5T, extensions 115, 170, 250, 470 mm
W zestawie: siłownik 270x395 mm, szczęki rozpierała 0.5 t, przedłużki 115, 170, 250, 470 mm

YATO	[t]	
YT-55500	4	1



Included: hydraulic cylinder 355x495 mm, expander jaws 0.5T, extensions 140, 240, 340, 590 mm
W zestawie: siłownik 355x495 mm, szczęki rozpierała 0.5 t, przedłużki 140, 240, 340, 590 mm

YATO	[t]	
YT-55503	10	1

EN Accessories for porta power
PL Pompa do rozpiękania hydraulicznego
DE Druckeinheit für hydraulischer Spreizer
RU Ручной насос для гидравлической распорной стойки
CZ Pumpa na hydraulický rozpěrák
HU Szivattyú hidraulikus bontóhoz

RO Pompa hidraulica
FR Pompe hydraulique manuelle
IT Pompa per martinetto idraulico
ES Bomba hidráulica para gato carroceros
CN 分离顶油泵

4t



For YT-55512
Dla YT-55512

YATO 	[t]	
YT-55510	4	1

EN Accessories for porta power
PL Siłownik do rozpiękania hydraulicznego
DE Kraftzylinder für hydraulischer Spreizer
RU Сервомотор для гидравлической распорной стойки
CZ Servomotor na hydraulický rozpěrák
HU Erőátvitel a hidraulikus bontóhoz

RO Accesorii pompa hidraulica
FR Presse hydraulique de la pompe
IT Cilindro per martinetto idraulico
ES Cilindro para gato carroceros
CN 千斤顶

4t



For YT-55510
Dla YT-55510

YATO 	[t]	
YT-55512	4	2

EN Electronic battery charger
PL Prostownik elektroniczny
DE Elektronisches Ladegerät
RU Электронное зарядное устройство
CZ Elektronická nabíječka
HU Elektronikus akkumulátortöltő

RO Redresor electric
FR Chargeur de batterie voiture
IT Aviatore elettronico
ES Cargador de batería para coche
CN 电池充电器

220-240V~
50-60Hz

6V
12V

1 | 4
A

max
120
Ah

WET
MOKRY
GEL
ŻELOWY
AGM

ALTERNATOR
TEST
TEST
ALTERNATORA

STARTER
TEST
TEST
ROZRUSZNIKA

x1
HOOK
TANK



YATO 	
YT-83033	20

EN Accessories for porta power
PL Pompa do rozpiękania hydraulicznego
DE Druckeinheit für hydraulischer Spreizer
RU Ручной насос для гидравлической распорной стойки
CZ Pumpa na hydraulický rozpěrák
HU Szivattyú hidraulikus bontóhoz

RO Pompa hidraulica
FR Pompe hydraulique manuelle
IT Pompa per martinetto idraulico
ES Bomba hidráulica para gato carroceros
CN 分离顶油泵

10t



For YT-55513
Dla YT-55513

YATO 	[t]	
YT-55511	10	1

EN Accessories for porta power
PL Siłownik do rozpiękania hydraulicznego
DE Kraftzylinder für hydraulischer Spreizer
RU Сервомотор для гидравлической распорной стойки
CZ Servomotor na hydraulický rozpěrák
HU Erőátvitel a hidraulikus bontóhoz

RO Accesorii pompa hidraulica
FR Presse hydraulique de la pompe
IT Cilindro per martinetto idraulico
ES Cilindro para gato carroceros
CN 千斤顶

10t



For YT-55511
Dla YT-55511

YATO 	[t]	
YT-55513	10	2

EN Electronic battery charger
PL Prostownik elektroniczny
DE Elektronisches Ladegerät
RU Электронное зарядное устройство
CZ Elektronická nabíječka
HU Elektronikus akkumulátortöltő

220-240V~
50Hz

6V
12V

2A
4A

max
200
Ah

WET
MOKRY
GEL
ŻELOWY
AGM / EFB

MICRO-PROCESSOR
MKRO-PROCESSOR

LCD



RO Redresor electric
FR Chargeur de batterie voiture
IT Aviatore elettronico
ES Cargador de batería para coche
CN 蓄电池充电器



YATO 	
YT-83000	20

EN Electronic battery charger
 PL Prostownik elektroniczny
 DE Elektronisches Ladegerät
 RU Электронное зарядное устройство
 CZ Elektronická nabíječka
 HU Elektronikus akkumulátortöltő
 RO Redresor electric
 FR Chargeur de batterie voiture
 IT Avviatore elettronico
 ES Cargador de batería para coche
 CN 蓄电池充电器

220-240V~ 50Hz	6V 12V	2A 8A	max 200 Ah	WET MOKRY GEL ZELOWY AGM / EFB	MICRO- PROCESSOR MIKRO- PROCESOR	LCD	
-------------------	-----------	----------	------------------	--	---	-----	---



YATO  **YT-83001**  20

EN Electronic battery charger
 PL Prostownik elektroniczny
 DE Elektronisches Ladegerät
 RU Электронное зарядное устройство
 CZ Elektronická nabíječka
 HU Elektronikus akkumulátortöltő
 RO Redresor electric
 FR Chargeur de batterie voiture
 IT Avviatore elettronico
 ES Cargador de batería para coche
 CN 蓄电池充电器

220-240V~ 50Hz	6V 12V	2A 10A	max 200 Ah	WET MOKRY GEL ZELOWY AGM / EFB	MICRO- PROCESSOR MIKRO- PROCESOR	LCD	
-------------------	-----------	-----------	------------------	--	---	-----	---



YATO  **YT-83002**  12

EN Electronic battery charger
 PL Prostownik elektroniczny
 DE Elektronisches Ladegerät
 RU Электронное зарядное устройство
 CZ Elektronická nabíječka
 HU Elektronikus akkumulátortöltő
 RO Redresor electric
 FR Chargeur de batterie voiture
 IT Avviatore elettronico
 ES Cargador de batería para coche
 CN 蓄电池充电器

220-240V~ 50Hz	12V	2A 8A 15A	max 200 Ah	WET MOKRY GEL ZELOWY AGM / EFB	MICRO- PROCESSOR MIKRO- PROCESOR	LCD	
-------------------	-----	-----------------	------------------	--	---	-----	---



YATO  **YT-83003**  8

EN Battery charger with boost function
 PL Prostownik z funkcją wspomagania ładowania
 DE Ladegerät mit Boost-Funktion
 RU Выпрямитель с функцией поддержки зарядки
 CZ Nabíječka s funkcií boost
 HU Akkumulátortöltő boost funkció
 RO Redresor baterie cu funcție boost
 FR Chargeur de batterie voiture support boost
 IT Caricabatterie con funzione boost
 ES Cargador de baterías con función boost
 CN 充电器启动机

220-240V~ 50-60Hz	12V	15A	max 300 Ah	WET MOKRY GEL ZELOWY AGM / EFB / MF	MICRO- PROCESSOR MIKRO- PROCESOR	LED DISPLAY WYŚWIETLACZ	
----------------------	-----	-----	------------------	---	---	-------------------------------	---



YATO  **YT-83037**  8

EN Battery charger with boost function
 PL Prostownik z funkcją wspomagania ładowania
 DE Ladegerät mit Boost-Funktion
 RU Выпрямитель с функцией поддержки зарядки
 CZ Nabíječka s funkcií boost
 HU Akkumulátortöltő boost funkció
 RO Redresor baterie cu funcție boost
 FR Chargeur de batterie voiture support boost
 IT Caricabatterie con funzione boost
 ES Cargador de baterías con función boost
 CN 充电器启动机

230V~ 50Hz	12V 24V	16A	120-240 Ah	WET MOKRY	
---------------	------------	-----	---------------	--------------	---



YATO  **YT-8304**  2

EN Battery charger with boost function
 PL Prostownik z funkcją wspomagania ładowania
 DE Ladegerät mit Boost-Funktion
 RU Выпрямитель с функцией поддержки зарядки
 CZ Nabíječka s funkcií boost
 HU Akkumulátortöltő boost funkció
 RO Redresor baterie cu funcție boost
 FR Chargeur de batterie voiture support boost
 IT Caricabatterie con funzione boost
 ES Cargador de baterías con función boost
 CN 充电器启动机

230V~ 50Hz	12V 24V	25 A	170-350 Ah	WET MOKRY	
---------------	------------	---------	---------------	--------------	---



YATO  **YT-8305**  2

EN Battery charger with boost function
 PL Prostownik z funkcją wspomagania ładowania
 DE Ladegerät mit Boost-Funktion
 RU Выпрямитель с функцией поддержки зарядки
 CZ Nabíječka s funkcií boost
 HU Akkumulátortöltő boost funkció

RO Redresor baterie cu funcție boost
 FR Chargeur de batterie voiture support boost
 IT Caricabatterie con funzione boost
 ES Cargador de baterías con función boost
 CN 充电器启动机

230V~ 50Hz	12V 24V	15A	12 V 75 A BOOST ROZRUCH	WET MOKRY GEL ZELOWY AGM	MICRO- PROCESSOR MIKRO- PROCESOR	
		10-300 Ah				



YATO  **YT-83051**  2

EN Battery charger with boost function
 PL Prostownik z funkcją wspomagania ładowania
 DE Ladegerät mit Boost-Funktion
 RU Выпрямитель с функцией поддержки зарядки
 CZ Nabíječka s funkcií boost
 HU Akkumulátortöltő boost funkció

RO Redresor baterie cu funcție boost
 FR Chargeur de batterie voiture support boost
 IT Caricabatterie con funzione boost
 ES Cargador de baterías con función boost
 CN 充电器启动机

230V~ 50Hz	12V 24V	30A	12 V 145 A BOOST ROZRUCH	WET MOKRY GEL ZELOWY AGM	MICRO- PROCESSOR MIKRO- PROCESOR	
		50-600 Ah				



YATO  **YT-83052**  2

EN Battery charger with engine start-up supporting function
PL Prostownik z funkcją wspomagania rozruchu
DE Ladegerät mit Starthilfe
RU Выпрямитель с функцией поддержки запуска
CZ Nabíječky s funkcí startování motoru
HU Akkumulátortöltő indító
RO Redresor cu funcția de pomnire de sprijin
FR Chargeur de batterie voiture support demarrage
IT Caricabatterie carrellato con funzione di avviatore rapido
ES Cargador de baterías arrancador
CN 充电器启动机



230V~
50Hz

12V 27A
START / ROZRUCH
300A

24V 25A
START / ROZRUCH
240A

20-600
Ah

WET
MOKRY



EN Battery charger with engine start-up supporting function
PL Prostownik z funkcją wspomagania rozruchu
DE Ladegerät mit Starthilfe
RU Выпрямитель с функцией поддержки запуска
CZ Nabíječky s funkcí startování motoru
HU Akkumulátortöltő indító
RO Redresor cu funcția de pomnire de sprijin
FR Chargeur de batterie voiture support demarrage
IT Caricabatterie carrellato con funzione di avviatore rapido
ES Cargador de baterías arrancador
CN 充电器启动机



230V~
50Hz

12V 32A
START / ROZRUCH
390A

24V 31A
START / ROZRUCH
360A

20-700
Ah

WET
MOKRY



EN Battery charger with engine start-up supporting function
PL Prostownik z funkcją wspomagania rozruchu
DE Ladegerät mit Starthilfe
RU Выпрямитель с функцией поддержки запуска
CZ Nabíječky s funkcí startování motoru
HU Akkumulátortöltő indító
RO Redresor cu funcția de pomnire de sprijin
FR Chargeur de batterie voiture support demarrage
IT Caricabatterie carrellato con funzione di avviatore rapido
ES Cargador de baterías arrancador
CN 充电器启动机



230V~
50Hz

12V 38A
START / ROZRUCH
540A

24V 35A
START / ROZRUCH
450A

20-800
Ah

WET
MOKRY



YATO
YT-83060



1

YATO
YT-83061



1

YATO
YT-83062



1

EN Jump starter with power bank
PL Urządzenie rozruchowe wielofunkcyjne
DE Multifunktions-Startgerät
RU Портативное пуско-зарядное устройство
CZ Multifunkční startovací zdroj a powerbanka
HU Többfunkciós autóindító
RO Acumulator extern pt. pomnire motor si incarcare
FR Démarreur de saut de voiture multifonctionnel
IT Avviatore portatile multifunzione
ES Arrancador de batería multifuncional para coche
CN 应急电源



7500
mAh

2 h
QUICK CHARGING
EXTREME LOWCOURSE

Li-Po

200 A
400 A
PEAK / SZCZYT

USB
5V / 2A

JUMP
STARTER
ROZRUCH
SILNIKA



YATO
YT-83080



20

EN Jump starter with power bank
PL Urządzenie rozruchowe wielofunkcyjne
DE Multifunktions-Startgerät
RU Портативное пуско-зарядное устройство
CZ Multifunkční startovací zdroj a powerbanka
HU Többfunkciós autóindító
RO Acumulator extern pt. pomnire motor si incarcare
FR Démarreur de saut de voiture multifonctionnel
IT Avviatore portatile multifunzione
ES Arrancador de batería multifuncional para coche
CN 应急电源



9000
mAh

3 h
QUICK CHARGING
EXTREME LOWCOURSE

Li-Po

200 A
400 A
PEAK / SZCZYT

12V
3.5 A
OUTPUT / WYJŚCIE

USB
5V / 2A

JUMP
STARTER
ROZRUCH
SILNIKA



YATO
YT-83081



10

EN Jump starter with power bank
PL Urządzenie rozruchowe wielofunkcyjne
DE Multifunktions-Startgerät
RU Портативное пуско-зарядное устройство
CZ Multifunkční startovací zdroj a powerbanka
HU Többfunkciós autóindító
RO Acumulator extern pt. pomnire motor si incarcare
FR Démarreur de saut de voiture multifonctionnel
IT Avviatore portatile multifunzione
ES Arrancador de batería multifuncional para coche
CN 应急电源

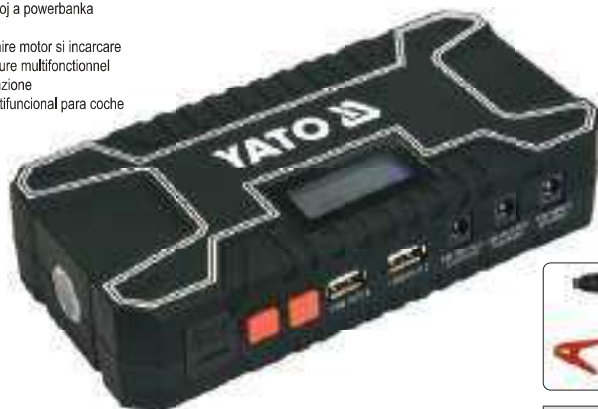

3.7 V
12000mAh
Li-Ion

300 A
500 A
PEAK / SZCZYT

USB
5V/2.4A

19V
3.5 A
OUTPUT / WYJŚCIE

12V
OUTPUT / WYJŚCIE

15V
INPUT / WEJŚCIE

4h
12000 mAh

LCD

JUMP
STARTER
ROZRUCH
SILNIKA



YATO
YT-83082



10

- EN Jump starter with power bank
- PL Urządzenie rozruchowe wielofunkcyjne
- DE Multifunktions-Startgerät
- RU Портативное пуско-зарядное устройство
- CZ Multifunkční startovací zdroj a powerbanka
- HU Többfunkciós autóindító
- RO Acumulator extern pt. pomire motor si incarcare
- FR Démarreur de saut de voiture multifonctionnel
- IT Avviatore portatile multifunzione
- ES Arrancador de batería multifuncional para coche
- CN 应急电源



- 10W
- 3.7 V 16000mAh
- USB 5V/2.1A
- USB 9V/ 2A
- 12V 8A OUTPUT (WYSIĘCZKA)
- 4h
- 16000 mAh
- LCD
- JUMP STARTER ROZRUCH SILNIKA
- USB
- USB 3.0
- USB BATTERY CHARGER ŁADOWNIKA
- Car icons: Car, Motorcycle, Boat, etc.
- Mobile phone, Tablet, MP3, Camera, etc.



YATO YT-83085 10

- EN Power inverter
- PL Przetwornica napięcia
- DE Spannungswandler
- RU Автомобильный инвертор
- CZ Měníč napětí
- HU Feszültség átalakító
- RO Convertor de tensiune
- FR Convertisseur de tension
- IT Inverter di corrente
- ES Convertidor de voltaje
- CN 逆变器

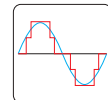

MODIFIED SINE WAVE SINUSOIDA MODYFKOWANA

- 12V INPUT (WEJŚCIE)
- 220-240V 50 Hz OUTPUT (WYJŚCIE)
- THERMAL PROTECTION ZABEZPIECZENIE TERMICZNE
- LOW VOLTAGE LEAK SIGNAL NIEBESZKODOWY PŁYDNOWY NAPIĘCIE



500 W
1000 W
PEAK / SZCZYT

YATO YT-81490 12



800 W
1600 W
PEAK / SZCZYT

YATO YT-81491 12

- EN Jumpstart wires
- PL Przewody rozruchowe
- DE Starterkabel
- RU Пусковые провода
- CZ Startovací kabely
- HU Indító kábelek
- RO Cabluri demarare
- FR Câbles de démarrage
- IT Cavi carica batteria
- ES Cables de arranque
- CN 输出线

2.5m



YATO [A] YT-83151 200 10



YATO [A] YT-83152 400 10



YATO [A] YT-83153 600 10

- EN Analogue battery tester
- PL Tester akumulatorów analogowy
- DE Analoges Batterieprüfgerät
- RU Аналоговый тестер аккумуляторов
- CZ Analogový tester akumulátorů
- HU Analóg akkuteszter
- RO Tester acumulatori analog
- FR Testeur de charge batterie
- IT Tester analogico per batteria
- ES Tester analógico para acumuladores
- CN 电池测试仪

- 6V 12V
- CCA 200-1000 A



YATO YT-8310 10

- EN Digital battery tester
- PL Tester akumulatorów cyfrowy
- DE Digitales Batterieprüfgerät
- RU Цифровой тестер аккумуляторов
- CZ Digitální tester autobaterií
- HU Digitális akkuteszter
- RO Tester acumulatori digital
- FR Testeur de batterie digital
- IT Tester digitale per batteria
- ES Comprobador de baterias digital
- CN 电池测试仪

- 12V
- CCA 150-1400 A
- LED DISPLAY WYŚWIETLACZ



YATO YT-8311 10

- EN Battery tester
- PL Tester akumulatorów
- DE Batterieprüfgerät
- RU Тестер аккумуляторов
- CZ Tester akumulátorů
- HU Akkuteszter
- RO Tester acumulatori
- FR Testeur de batterie
- IT Tester per batteria
- ES Tester para acumuladores
- CN 电池测试仪

- 12V BATTERY TEST TEST AKUMULATORA
- ALTERNATOR TEST TEST ALTERNATORA



YATO YT-83101 12/72

EN Digital battery tester
PL Elektroniczny tester akumulatorów
DE Elektronischer Batterieleser
RU Электронный тестер аккумуляторов
CZ Digitální tester autobaterií
HU Elektronikus akkumulátor tesztelő
RO Tester electronic acumulatori
FR Testeur de batterie électronique
IT Tester elettronico per batterie
ES Comprobador electrónico de baterías
CN 电池检测仪



YATO  **YT-83113**  6/48

EN Digital battery tester
PL Elektroniczny tester akumulatorów
DE Elektronischer Batterieleser
RU Электронный тестер аккумуляторов
CZ Digitální tester autobaterií
HU Elektronikus akkumulátor tesztelő
RO Tester electronic acumulatori
FR Testeur de batterie électronique
IT Tester elettronico per batterie
ES Comprobador electrónico de baterías
CN 电池检测仪



YATO  **YT-83114**  56

EN OBD2 multilingual scan tool
PL Tester diagnostyczny OBD2
DE OBD2-Diagnosegerät
RU Диагностический тестер OBD2
CZ Diagnostický tester OBD2
HU OBD2 hibakód olvasó tesztelő
RO Tester diagnoza auto OBD2
FR Appareil de diagnostic OBD2
IT Strumento diagnostico OBD2
ES Comprobador de diagnóstico OBD2
CN 多语言汽车读卡卡



YATO  **YT-72977**  10/60

EN OBD2 multilingual scan tool
PL Tester diagnostyczny OBD2
DE OBD2-Diagnosegerät
RU Диагностический тестер OBD2
CZ Diagnostický tester OBD2
HU OBD2 hibakód olvasó tesztelő
RO Tester diagnoza auto OBD2
FR Appareil de diagnostic OBD2
IT Strumento diagnostico OBD2
ES Comprobador de diagnóstico OBD2
CN 多语言汽车读卡卡



YATO  **YT-72978**  40

EN Injector tester scan tool
PL Elektroniczny tester wtryskiwaczy silników benzynowych
DE Elektronisches Benzin-Einspritzdüsen-Prüfgerät
RU Электронный тестер для инжекторов бензинового двигателя
CZ Elektronický tester trysek benzinového motoru
HU Elektromos tesztelő benzinmotor befecskendezőhöz
RO Tester scanare injectoare
FR Testeur électronique d'injecteurs de moteurs à essence
IT Tester elettronico per iniettori per motori a benzina
ES Probador electrónico para inyectoros de motores de gasolina
CN 汽车喷油器测试仪



YATO  **YT-72960**  8/48

EN Refractometer
PL Refraktometr
DE Refraktometer
RU Рефрактометр
CZ Refraktometr
HU Fagyálló fókáló
RO Refractometru
FR Réfractomètre
IT Rifratometro
ES Refractometro
CN 冰点仪



YATO  **YT-06722**  25

- EN Auto retract electric cable reel
- PL Przedłużacz elektryczny na zwijaku automatycznym
- DE Elektro-Kabelaufroller mit automatischem Einzug
- RU Электрический удлинитель на автоматическом барабане
- CZ Elektrický prodlužovací kabel na automatickém navijáku
- HU Elektromos hosszabbító automatikus csévéltővel
- RO Prelungitor electric retractabil
- FR Câble de rallonge électrique sur enrouleur automatique
- IT Prolunga elettrica con avvolgicavo automatico
- ES Prolongador eléctrico en enrollador automático
- CN 电卷管器



10A ~250V	CABLE H05VV-F KABEL	3G 1.5 mm ²	
	IP34		EASILY MOUNT LATWY MONTAZ

- P_{max} = 2500 W coiled
- P_{max} = 2500 W uncoiled
- P_{max} = 2500 W zwinięty
- P_{max} = 2500 W rozwinięty

YATO	L [m]	
YT-81220	10	4
YT-81221	20	2

- EN Chain block
- PL Wyciągarka łańcuchowa
- DE Kettenzug Flaschenzug
- RU Таль цепная
- CZ Zvedák řetězový
- HU Láncos csigasor emelő
- RO Scipete cu lant
- FR Treuil à chaîne
- IT Paranco a catena
- ES Cabria de cadena
- CN 三角手拉葫芦



3m

- EN Lever block
- PL Wciągnik łańcuchowy
- DE Kettenzug Hebelzug
- RU Таль ручная рычажная
- CZ Kladkostroj díl
- HU Emelő robusztus
- RO Bloc de pârghie
- FR Bloc de levier
- IT Paranco a catena
- ES Bloque de palanca
- CN 手扳葫芦



1.5 m

YATO	Max. load capacity / Maks. obciążenie [kg]	
YT-58950	500	1
YT-58951	1000	1
YT-58953	2000	1
YT-58954	3000	1
YT-58955	5000	1

YATO	Max. lifting capacity / Maks. udźwig [kg]	
YT-58962	7500	1
YT-58964	1500	1
YT-58966	3000	1
YT-58967	6000	1

- | | | | |
|----------------------|-------------------------------|------------------------------|----------------------|
| EN Rope winch | RU Канатная лебедка | RO Troliu cu cablu orizontal | ES Cabría de cuerdas |
| PL Wyciągarka linowa | CZ Lanové vyťahovací zařízení | FR Treuil à corde | CN 绳索拉紧器 |
| DE Handseilwinde | HU Drótköteles csőrítő | IT Paranco a corda | |

1000 daN 3m



YATO	Rope length / Długość liny [m]	Rope diameter / Średnica liny [mm]	
YT-5911	3	5	6

- | | | | |
|----------------------|-------------------------------|------------------------------|----------------------|
| EN Rope winch | RU Канатная лебедка | RO Troliu cu cablu orizontal | ES Cabría de cuerdas |
| PL Wyciągarka linowa | CZ Lanové vyťahovací zařízení | FR Treuil à corde | CN 绳索拉紧器 |
| DE Handseilwinde | HU Drótköteles csőrítő | IT Paranco a corda | |

1300 daN 3m



YATO	Rope length / Długość liny [m]	Rope diameter / Średnica liny [mm]	
YT-5913	3	5	6

- | | | | |
|----------------------|-------------------------------|------------------------------|----------------------|
| EN Rope winch | RU Канатная лебедка | RO Troliu cu cablu orizontal | ES Cabría de cuerdas |
| PL Wyciągarka linowa | CZ Lanové vyťahovací zařízení | FR Treuil à corde | CN 绳索拉紧器 |
| DE Handseilwinde | HU Drótköteles csőrítő | IT Paranco a corda | |

1500 daN 3m



YATO	Rope length / Długość liny [m]	Rope diameter / Średnica liny [mm]	
YT-5914	3	6	3

EN Transmission jack
PL Podnośnik skrzyni biegów
DE Hydraulische Getriebeheber
RU Домкрат для коробки передач
CZ Pojízdný zvedák motorů a převodovek
HU Sebességváltó emelő tartó
RO Cric cutii de viteza
FR Levage des moteurs et des boîtes de vitesses
IT Sollevatore scatola del cambio
ES Motor de transmisión telescópica
CN 坡道



max **500 kg**
1900 1100 mm
PRECISION VALVE
PRECYZYJNY ZAWOR

EN Transmission jack
PL Podnośnik skrzyni biegów
DE Hydraulische Getriebeheber
RU Домкрат для коробки передач
CZ Pojízdný zvedák motorů a převodovek
HU Sebességváltó emelő tartó
RO Cric cutii de viteza
FR Levage des moteurs et des boîtes de vitesses
IT Sollevatore scatola del cambio
ES Motor de transmisión telescópica
CN 运送顶



max **500 kg**
1945 1140 mm
PRECISION VALVE
PRECYZYJNY ZAWOR

YATO

YT-55601



1

YATO

YT-55600



1

EN Parts washer
PL Myjka warsztatowa
DE Teilwaschgerät
RU Стенд для очистки деталей
CZ Mycí stůl na součástky
HU Alkatrészmosó
RO Cuva pt. spalat piese
FR Fontaine de nettoyage pièces
IT Idropulitrice per officina
ES Lavadora piezas mecánicas
CN 零件清洗机



230V~
50Hz

720x480
x260 mm

880
mm

80 L

10
l/min

FOR SOLVENT
WATER BASED
DO PŁYŃCOW
NA BAZIE WODY



EN Sandblasting cabinet
PL Piaskarka kabinowa
DE Sandstrahlkabine
RU Пескоструйная камера
CZ Pískovací box
HU Homokszórő kabin
RO Cabina de sablat
FR Cabine de sablage
IT Sabbiatrica a cabina
ES Cabina de chorro de arena
CN 喷砂机

230V~
50Hz

0.82
MPa

90 L

585x490
x490 mm

STANDARD



$L_{pA} = 93,5 \pm 3,0$ dB; $L_{wA} = 95,0 \pm 3,0$ dB; $a_0 = <2,5$ m/s²

YATO

YT-55808



1

YATO

YT-55840



1

EN Nozzle for sandblaster cabinet
PL Dysze ceramiczne do piaskarki kabinowej
DE Keramikdüsen für Sandstrahlkabine
RU Керамические насадки для пескоструйной камеры
CZ Keramické trysky pro kabinový pískovací stroj
HU Kerámia fúvókák homokszórő kabinhoz
RO Duze pt. aparat de sablat
FR Buses en céramique pour cabine de sablage
IT Ugelli ceramici per sabbiatrica a cabina
ES Boquillas cerámicas para cabinas de chorro de arena
CN 四件套喷嘴

4
PCS

4, 5,
6, 7
mm



For YT-55840
Dla YT-55840

YATO

YT-55844

Ø [mm]



20/200

EN Protective films for sandblasting cabinet
PL Folie ochronne do piaskarki kabinowej
DE Schutzfolien für Sandstrahlkabine
RU Защитные пленки для пескоструйной камеры
CZ Ochranná fólie průzoru pro pískovací box
HU Védőfólia a homokszórőhöz
RO Folie protecție pt. cabina de sablat
FR Film de protection pour cabine de sablage
IT Pellicola protettiva per cabina sabbiatrica
ES Películas de protección para cabinas de chorro de arena
CN 四片装保护片

4
PCS

410x300
mm



For YT-55840
Dla YT-55840

YATO

YT-55845

[mm]



50/100

EN Gloves for sandblasting cabinet
PL Rękawice do piaskarki kabinowej
DE Handschuhe für Sandstrahlkabine
RU Перчатки для пескоструйной камеры
CZ Rukavice do pískovacích boxů
HU Homoklívó szekrényhez kesztyű
RO Manusi pt. cabina de sablat
FR Gants pour cabine de sablage
IT Guanti per cabina sabbiatrica
ES Guantes para cabinas de chorro de arena
CN 手套



For YT-55840
Dla YT-55840

YATO

YT-55846



25

EN Shop crane
 PL Żuraw warsztatowy
 DE Werkstattkran
 RU Кран подкатной гидравлический
 CZ Hydraulický jeřáb
 HU Motorkiemelő zsráf

RO Girafa pt. scos motor
 FR Grue d'atelier
 IT Gru idraulica
 ES Grúa hidráulica para motores
 CN 吊机



1000
kg

6x  STEEL STAL



EN Shop crane
 PL Żuraw warsztatowy
 DE Werkstattkran
 RU Кран подкатной гидравлический
 CZ Hydraulický jeřáb
 HU Motorkiemelő zsráf

RO Girafa pt. scos motor
 FR Grue d'atelier
 IT Gru idraulica
 ES Grúa hidráulica para motores
 CN 吊机



2000
kg

6x  STEEL STAL





YATO  **YT-55556**  1



YATO  **YT-55557**  1

EN Shop press
 PL Prasa hydrauliczna
 DE Hydraulische Werkstattpresse
 RU Гидравлический пресс
 CZ Hydraulický lis
 HU Hidraulikus prés

RO Presa hidraulic
 FR Presse hydraulique
 IT Pressa idraulica
 ES Prensa de hidráulica
 CN 压力机

12t

695
0
mm

400
mm



YATO  **YT-55580**  1

EN Shop press
 PL Prasa hydrauliczna
 DE Hydraulische Werkstattpresse
 RU Гидравлический пресс
 CZ Hydraulický lis
 HU Hidraulikus prés

RO Presa hidraulic
 FR Presse hydraulique
 IT Pressa idraulica
 ES Prensa de hidráulica
 CN 压力机

20t

695
0
mm

490
mm



YATO  **YT-55581**  1

EN Shop press
 PL Prasa hydrauliczna
 DE Hydraulische Werkstattpresse
 RU Гидравлический пресс
 CZ Hydraulický lis
 HU Hidraulikus prés

RO Presa hidraulic
 FR Presse hydraulique
 IT Pressa idraulica
 ES Prensa de hidráulica
 CN 压力机

30t

795
0
mm

520
mm



YATO  **YT-55582**  1

- EN Engine bar with support arm
- PL Belka z poprzeczką do podwieszania silnika
- DE Motorbrücke mit Tragarm
- RU Балка с перекладиной для подвески двигателя
- CZ Nosník s příčkou pro zavěšení motoru
- HU Motorfűggesztő gerenda
- RO Suport ridicare motor
- FR Poutre de support moteur avec barre transversale
- IT Ponte per motori con traversa
- ES Barra de soporte del motor con traviesa
- CN 引擎支架



90-160 cm
max 320 kg 

YATO 
YT-55567  1

- EN Engine suspension beam
- PL Belka do podwieszenia silnika
- DE Aufnahmevorrichtung des Motors
- RU Балка для вывешивания двигателя
- CZ Nosník k zavěšení motoru
- HU Motorfűggesztő gerenda
- RO Grindă pt. suspendarea motorului
- FR Poutre de suspension de moteur
- IT Fascio sospensione del motore
- ES La viga para suspender el motor
- CN 引擎支架



150 cm
max 500 kg 

YATO 
YT-55568  1

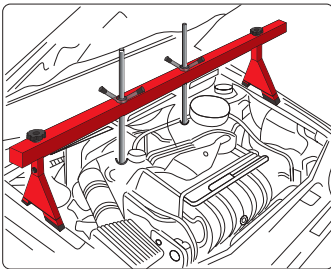

- EN Crane crossbeam
- PL Traversa do żurawia
- DE Traverse zum Kran
- RU Траверса для крана
- CZ Jefábová traverza
- HU Traverz a zsiráf emelőhöz
- RO Traversă pt. macara
- FR Balancier pour grue d'atelier
- IT Traversa per gru
- ES Viga transversal para grua
- CN 平衡器

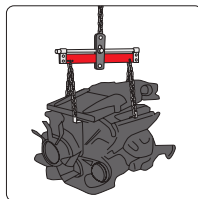



315 mm
max 680 kg 



YATO 
YT-55565  1

- EN Engine stand
- PL Stojak do silnika
- DE Motorständer
- RU Стойка для ремонта двигателя
- CZ Stojan na motor
- HU Motorszerelő állvány
- RO Suport pt. motor
- FR Support moteur
- IT Cavalletto per motore
- ES Soporte de motor
- CN 发动机支架

max 450 kg
0-360°
4x  STEEL STAL 



YATO 
YT-55570  1

EN Self locking nuts assortment
 PL Zestaw nakrętek metrycznych z zabezpieczeniem
 DE Sortiment Muttern metrisch mit Sicherheit
 RU Набор гаек самоконтращихся, с нейлоновой вставкой
 CZ Šestihránné matice s bezpečností
 HU Nuts metrikus menet biztonságáig

RO Set piulițe autoblocante
 FR Hex écrou set avec la sécurité
 IT Set di autobloccanti metrica dadi
 ES Porcas rosca métrica con a seguridad
 CN 螺母组套

146
PCS

MIX

METRIC
METRYCZNY

INTERNAL
SECURITY
WEINMETRISCH
ZABEZPIECZENIE



M4, M5, M6, M8, M10, M12

YATO
YT-06774

5/20

EN Stainless steel nuts assortment
 PL Zestaw nakrętek metrycznych nierdzewnych
 DE Sortiment Muttern metrisch rostfrei
 RU Набор гаек шестигранных нержавеющей
 CZ Nerezové oceli šestihránné matice
 HU Nuts metrikus menet rozsdmentes

RO Set piulițe inox
 FR Hex écrou set inoxydable
 IT Set di acciaio inossidabile metrica dadi
 ES Rosca métrica tuercas inoxidable
 CN 螺母

300
PCS

MIX

METRIC
METRYCZNY

SS
STAINLESS STEEL
STAL NIERDZEWNA



M3, M4, M5, M6, M8, M10

YATO
YT-06773

5/20

EN Metric wing nut assortment
 PL Zestaw nakrętek motylkowych
 DE Sortiment Flügelmuttern
 RU Набор гаек типа «барашек»
 CZ Křídlaté matice lisované
 HU Szárnyas anya

RO Set piulițe fluture
 FR Assortiment d'écrous papillon
 IT Set di metrica dadi
 ES Tuercas con orejas
 CN 蝶形螺母组套

150
PCS

MIX

METRIC
METRYCZNY



M4, M5, M6, M8, M10

YATO
YT-06776

25

EN Metric nuts assortment
 PL Zestaw nakrętek metrycznych
 DE Sortiment Muttern metrisch
 RU Набор гаек
 CZ Šestihránné matice
 HU Nuts metrikus menet

RO Set piulițe
 FR Hex écrou set
 IT Set di metrica dadi
 ES Porcas rosca métrica
 CN 螺母组套

300
PCS

MIX

METRIC
METRYCZNY

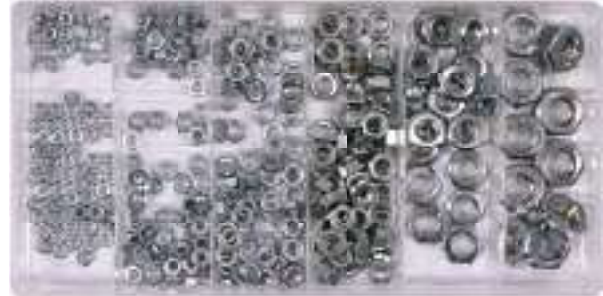

M3, M4, M5, M6, M8, M10

YATO
YT-06772

5/20

EN Hex nut with top assortment
 PL Zestaw nakrętek metrycznych kolpakowych
 DE Sortiment Muttern metrisch geschlossen
 RU Набор гаек колпачковых
 CZ Šestihránné matice zavřeno
 HU Nuts metrikus menet zárt

RO Set piulițe inchise
 FR Hex écrou set fermé
 IT Set di dadi campana-metrica
 ES Rosca métrica tuercas cerrado
 CN 螺母

150
PCS

MIX

METRIC
METRYCZNY



M3, M4, M5, M6, M8, M10

YATO
YT-06775

5/20

EN Aluminium washer set
 PL Zestaw podkładek aluminiowych
 DE Aluminium Dichttring Sortiment
 RU Набор алюминиевых шайб
 CZ Sada hliníkových podložek
 HU Réz alátét készlet

RO Set saibe aluminiu
 FR Assortiment de joints en aluminium
 IT Set di rondelle in alluminio
 ES Juego de cuñas de aluminio
 CN 铝垫片

300
PCS

MIX

METRIC
METRYCZNY

AI



5x9x1.0 mm, 8x14x1.5 mm, 12x16x1.0 mm, 14x20x1.5 mm, 18x24x1.5 mm, 22x29x1.5 mm, 6x10x1.0 mm, 9x14x1.0 mm, 12x16x1.5 mm, 14x20x2.0 mm, 20x24.5x1.5 mm, 24x29x1.5 mm, 6x12x1.0 mm, 10x14x1.0 mm, 12x18x1.5 mm, 16x20x1.5 mm, 20x24.5x0.8 mm, 24x32x2.0 mm, 8x12x1.0 mm, 10x14x1.5 mm, 13x18x1.0 mm, 16x22x1.5 mm, 19x26x2.0 mm, 26x34x2.0 mm, 8x14x1.0 mm, 10x16x1.0 mm, 14x18x1.5 mm, 18x22x1.5 mm, 22x27x1.0 mm, 28x36x2.0 mm (x10 PCS)

YATO
YT-06865

5/20

EN Aluminium washer set
PL Zestaw podkładek aluminiowych
DE Aluminium Dichting Sortiment
RU Набор алюминиевых шайб
CZ Sada hliníkových podložek
HU Réz alátét készlet
RO Set saibe aluminiu
FR Assortiment de joints en aluminium
IT Set di rondelle in alluminio
ES Juego de cuñas de aluminio
CN 铝垫片

450
PCS

MIX

METRIC
METRYCZNY

AI



10x6x1.0 mm (40 PCS), 12x6x1.2 mm (40 PCS), 12x8x1.0 mm (40 PCS), 14x8x1.0 mm (40 PCS), 14x10x1.0 mm (40 PCS), 16x10x1.0 mm (40 PCS), 16x12x1.5 mm (20 PCS), 18x12x1.5 mm (20 PCS), 18x14x1.5 mm (20 PCS), 20x14x1.5 mm (20 PCS), 20x16x1.5 mm (20 PCS), 22x16x1.5 mm (20 PCS), 22x18x1.5 mm (20 PCS), 24x18x1.5 mm (20 PCS), 26x20x1.5 mm (20 PCS), 27x22x1.5 mm (10 PCS), 29x22x1.5 mm (10 PCS), 29x24x2.0 mm (10 PCS)

YATO
YT-068652 24

EN Drain plug gasket assortment
PL Zestaw podkładek do korków spustowych
DE Unterlegscheiben-Set für Ablassschrauben
RU Комплект шайб для сливных пробок
CZ Sada podložek pro vypouštěcí zátky
HU Leeresztőcsavar alátétkészlet

RO Set garnituri pt. scurgere
FR Rondelles de bouchon de vidange
IT Kit di rondelle per tappi di scarico
ES Juego de arandelas para tapones de descarga
CN 油底垫圈

120
PCS

MIX

NYLON

FIBER
WŁÓKNO



12x24.7x2 mm, 13.6x24.7x2 mm; Steel+NBR; 13x19x2.3 mm, 16x26x2.3 mm, 18x22x2.3 mm, 19x27x2.3 mm, 24x29x2.3 mm, 14.5x24x2 mm, 13x24x1.5 mm, 12x22x1.5 mm, 14x19.5x1.5 mm; Nylon; 12x22x1.5 mm, 18x28x2 mm, 20x27x1.5 mm, 13x22x2 mm, 14x20x1.5 mm; Fibre / Włókno; 13x18x1.2 mm, 16x22x1.5 mm, 20x26x2.5 mm, 14x20x1.3 mm; Cu; 14x24x2 mm; Al; 12x18x2 mm; Cu crush / Cu dmuchana; 12x20x2mm, 14x21x2.5mm; NBR; (x5 PCS)

YATO
YT-068641 12

EN Copper washer set
PL Zestaw podkładek miedzianych
DE Kupfer Dichting Sortiment
RU Набор медных колец
CZ Podložky mědné těsnící
HU Réz tömítés készlet

RO Saibe din cupru
FR Patins en cuivre
IT Set di spessori
ES Arandelas de cobre
CN 紫铜垫片

220
PCS

MIX

SOFT
MATERIAL
MIĘKKI
MATERIAL

Cu



4x8x1 mm, 5x9x1 mm, 6x10x1 mm, 6x12x1 mm (x25 PCS); 8x12x1 mm, 8x14x1 mm, 10x14x1 mm, 10x16x1 mm, 12x16x1.5 mm, 12x18x1.5 mm, 14x18x1.5 mm, 14x20x1.5 mm, 16x20x1.5 mm, 18x24x1.5 mm, 20x26x1.5 mm, 22x27x1.5 mm (x10 PCS)

YATO
YT-068721 24

EN Copper crush washer set
PL Zestaw podkładek miedzianych dmuchanych
DE Satz geblasener Kupfer-Passplatten
RU Комплект медных шайб
CZ Sada foukaných mědných podložek
HU Réz alátét készlet

RO Set saibe cupru
FR Jeu de rondelles en cuivre
IT Set di rondelle di rame soffiate
ES Conjunto de arandelas de cobre para tapón cárter
CN 铜环圈

95
PCS

MIX

Cu



8.4x12x1.8 mm (10 PCS), 10.4x15.8x2.0 mm (15 PCS), 12.4x17.8x2.2 mm (15 PCS), 14.4x19.8x2.2 mm (20 PCS), 16.4x21.8x2.0 mm (20 PCS), 18.2x23.8x2.2 mm (10 PCS), 20.2x25.8x2.2 mm (5 PCS)

YATO
YT-068713 24

EN Copper washer set
PL Zestaw podkładek miedzianych
DE Kupfer Dichting Sortiment
RU Набор медных колец
CZ Podložky mědné těsnící
HU Réz tömítés készlet

RO Saibe din cupru
FR Patins en cuivre
IT Set di spessori
ES Arandelas de cobre
CN 紫铜垫片

150
PCS

MIX

Cu



5x10x1.0 mm, 6x10x1.0 mm, 7x10x1.0 mm, 8x11x1.0 mm, 10x16x1.0 mm, 10.5x17x1.5 mm, 11x17x1.5 mm, 14x18x1.0 mm, 12x20x1.5 mm, 12.5x20x1.5 mm, 14x20x1.5 mm, 15x20x2.0 mm, 16x22x2.0 mm, 16.5x24x2.0 mm, 17.5x24x2.0 mm (x10 PCS)

YATO
YT-06871 5/20

EN Copper washer set
PL Zestaw podkładek miedzianych
DE Kupfer Dichting Sortiment
RU Набор медных колец
CZ Podložky mědné těsnící
HU Réz tömítés készlet

RO Saibe din cupru
FR Patins en cuivre
IT Set di spessori
ES Arandelas de cobre
CN 紫铜垫片

300
PCS

MIX

METRIC
METRYCZNY

Cu

SOFT
MATERIAL
MIĘKKI
MATERIAL



5x9x1.0 mm, 8x14x1.5 mm, 12x16x1.0 mm, 14x20x1.5 mm, 18x24x1.5 mm, 22x29x1.5 mm, 6x10x1.0 mm, 9x14x1.0 mm, 12x16x1.5 mm, 14x20x2.0 mm, 20x24.5x1.5 mm, 24x29x1.5 mm, 6x12x1.0 mm, 10x14x1.0 mm, 12x18x1.5 mm, 16x20x1.5 mm, 20x24.5x0.8 mm, 24x32x2.0 mm, 8x12x1.0 mm, 10x14x1.5 mm, 13x18x1.0 mm, 16x22x1.5 mm, 19x26x2.0 mm, 26x34x2.0 mm, 8x14x1.0 mm, 10x16x1.0 mm, 14x18x1.5 mm, 18x22x1.5 mm, 22x27x1.0 mm, 28x36x2.0 mm (x10 PCS)

YATO
YT-06872 5/20

EN Copper washer set
 PL Zestaw podkładek miedzianych
 DE Kupfer Dichttring Sortiment
 RU Набор медных колец
 CZ Podložky měděné těsnící
 HU Réz tömítés készlet

RO Saibe din cupru
 FR Patins en cuivre
 IT Set di spessori
 ES Arandelas de cobre
 CN 紫铜垫片

580
PCS

MIX

Cu



4x8x1 mm, 4x9x1 mm, 7x10x1 mm, 8x12x1 mm, 6x12x1 mm, 8x14x1 mm, 10x16x1 mm, 11x17x1 mm, 10,5x17x1 mm, 12x16x1 mm (x30 PCS); 8x16x1 mm, 13x18x1 mm, 14x18x1 mm, 12x19x1 mm, 14x20x1 mm, 16x20x1 mm (x20 PCS); 17x21x1 mm, 17x23x1 mm, 18x22x1 mm, 18x24x1 mm (x15 PCS); 19x26x1 mm, 22x26x1 mm, 24x29x1 mm, 20x28x1 mm, 22x29x1 mm, 26x31x1 mm, 24x32x1 mm, 27x32x1 mm, 26x34x1 mm, 30x36x1 mm (x10 PCS)

YATO

YT-068711

20

EN Copper gasket & oil drain plug assortment
 PL Zestaw podkładek miedzianych i korków spustowych
 DE Ölablassschraube Kupfer Schrauben und O-Ringe
 RU Набор медных шайб и сливных пробок поддона двигателя
 CZ Sada měděných podložek a zátek pro olejové výrůstě
 HU Olajteknő csavar és rézalátét készlet
 RO Set busoane baie ulei
 FR Boulons de carter d'huile & assortiment bagues
 IT Set di rondelle in rame a spine
 ES Tornillos y juntas para tapon de carter
 CN 油封

534
PCS

MIX

Cu



6 mm (50 PCS), 8 mm (50 PCS), 10 mm (50 PCS), 12 mm (50 PCS), 13 mm (50 PCS), 14 mm (50 PCS), 15 mm (50 PCS), 16 mm (50 PCS), 18 mm (50 PCS), 20 mm (50 PCS); M8x1.0 (5 PCS), M10x1.0 (5 PCS), M12x1.5 (5 PCS), M14x1.5 (5 PCS), M16x1.5 (3 PCS), M18x1.5 (3 PCS), M20x1.5 (3 PCS); G1/4 (5 PCS)

YATO

YT-06864

10

EN Aluminum gasket and oil drain plug assortment
 PL Zestaw podkładek aluminiowych i korków spustowych
 DE Alu-Unterlegscheiben- und Ölablassschrauben-Satz
 RU Набор алюминиевых подкладок и пробок
 CZ Sada hliníkových podložek a vypošťechých zátek
 HU Alumínium alátét és leeresztőcsavar készlet
 RO Set garnituri al. si busoane baie ulei
 FR Jeu de rondelles et de bouchons de vidange en aluminium
 IT Kit di rondelle in alluminio e tappi di scarico
 ES Juego de arandelas de aluminio y tapones de descarga
 CN 油封

534
PCS

MIX

Al



6 mm (50 PCS), 8 mm (50 PCS), 10 mm (50 PCS), 12 mm (50 PCS), 13 mm (50 PCS), 14 mm (50 PCS), 15 mm (50 PCS), 16 mm (50 PCS), 18 mm (50 PCS), 20 mm (50 PCS); M10 (5 PCS), M12 (5 PCS), M13 (5 PCS), M14 (5 PCS), M15 (5 PCS), M16 (3 PCS), M18 (3 PCS), M20 (3 PCS)

YATO

YT-06862

12

EN Oil seal washer assortment
 PL Zestaw podkładek metalowo-gumowych
 DE Satz Metall- und Gummischaiben
 RU Набор металлорезиновых шайб
 CZ Sada podložek kov-guma
 HU Fém-gumi alátétkészlet

RO Set șaibe simeringuri
 FR Jeu de rondelles en métal et en caoutchouc
 IT Kit di rondelle in metallo et gomma
 ES Juego de arandelas metal goma
 CN 橡胶复合垫片

90
PCS

MIX

NBR70

STEEL STAL



M10x1.9 mm (20 PCS), M12x1.9 mm (20 PCS), M14x1.9 mm (20 PCS), M16x1.9 mm (10 PCS), M18x1.9 mm (5 PCS), M20x1.9 mm (5 PCS), M22x1.9 mm (5 PCS), M24x1.9 mm (5 PCS)

YATO

YT-068581

24

EN Oil seal washer assortment
 PL Zestaw podkładek metalowo-gumowych
 DE Satz Metall- und Gummischaiben
 RU Набор металлорезиновых шайб
 CZ Sada podložek kov-guma
 HU Fém-gumi alátétkészlet

RO Set șaibe simeringuri
 FR Jeu de rondelles en métal et en caoutchouc
 IT Kit di rondelle in metallo et gomma
 ES Juego de arandelas metal goma
 CN 橡胶复合垫片

150
PCS

MIX

NBR70

STEEL STAL



M6x1.0 mm (10 PCS), M8x1.9 mm (10 PCS), M10x1.9 mm (10 PCS), M12x1.9 mm (20 PCS), M14x1.9 mm (20 PCS), M16x1.9 mm (20 PCS), M18x1.9 mm (20 PCS), M20x1.9 mm (20 PCS), M22x1.9 mm (10 PCS), M24x1.9 mm (10 PCS)

YATO

YT-068582

24

EN Bodywork nuts & screws assortment
 PL Zestaw wkrętów i podkładek do karoserii
 DE Sortiment Karosseriemuttern mit Schrauben
 RU Набор саморезов и металлических клипс для кузовных работ
 CZ Tělo matice a šroub kit
 HU Karosszéria csavar és anya készlet

RO Set asamblare dema, holsuruburi
 FR Assortiment de vis et d'écrous cage
 IT Set viti e rondelle al corpo
 ES Body kit tornillo
 CN 螺丝组套

170
PCS

MIX



M3, M4, M5, M6;
 M3x8 mm, M4x16 mm, M5x12 mm, M6x20 mm

YATO

YT-06780

5/20

EN Clevis pin assortment
PL Zestaw sworzni z iberami i otworami
DE Bolzen mit Kopf
RU Набор штифтов с отверстиями под шплинт
CZ Čepy s hlavou
HU Csapszeget kit

RO Set bolturi pt. securizare
FR Axe de chape
IT Set di perni con testa e il foro
ES Kit de pasador de horquilla
CN 销柱

60
PCS

5-12
mm

MIX



5x25 mm, 6x25 mm, 6x30 mm, 6x40 mm, 6x45 mm, 6x50 mm, 6x60 mm, 6x65 mm, 8x25 mm, 8x30 mm, 8x40 mm, 8x45 mm, 8x50 mm, 8x60 mm, 8x65 mm, 8x70 mm, 10x25 mm, 10x40 mm, 10x50 mm, 12x40 mm, 12x50 mm

YATO  
YT-06786 4/16

EN Spring assortment
PL Zestaw sprężynek
DE Schraubenfeder Sortiment
RU Набор пружинок оцинкованных
CZ Sada pružin
HU Rugós készlet

RO Arcuri tensiune
FR Assortiment ressorts
IT Set di molle
ES Caja surtido de de resortes
CN 弹簧组套

200
PCS

MIX



4.0x79.5 mm (12 PCS), 4.5x44.5 mm (8 PCS), 5.0x20.5 mm (10 PCS), 5.5x17.5 mm (10 PCS), 5.5x25.5 mm (10 PCS), 5.5x38.0 mm (10 PCS), 6.5x10.0 mm (10 PCS), 6.5x22.0 mm (10 PCS), 7.0x12.5 mm (10 PCS), 7.0x19.0 mm (10 PCS), 7.0x38.0 mm (10 PCS), 7.0x51.0 mm (12 PCS), 8.0x28.5 mm (8 PCS), 8.0x31.5 mm (10 PCS), 8.0x44.5 mm (12 PCS), 8.5x36.5 mm (10 PCS), 8.5x47.0 mm (12 PCS), 9.0x35.0 mm (8 PCS), 9.5x16.0 mm (6 PCS), 9.5x19.0 mm (12 PCS)

YATO  
YT-06875 5/20

EN Hitch pin assortment set
PL Zestaw zawleczek sprężystych
DE Federsplinte Sortiment
RU Набор шплинтов с фиксацией
CZ Pružinové závlačky
HU Rugós csap

RO Set sigurante securizare
FR Assortiment goupilles beta
IT Set di spine elastiche
ES Pasadores surtido beta
CN R型销

150
PCS

6
SPEC
ROZMĚRY



2.0x33 mm, 2.0x40 mm, 2.4x31 mm, 2.8x42 mm, 3.5x45 mm, 4.0x75 mm

YATO  
YT-06883 6/24

EN Grease nipple set
PL Zestaw smarowniczek
DE Schmiernippel
RU Набор масленок
CZ Sady mazacích hlavic
HU Zsírzögomb (zsírzófejt) készlet

RO Set gresoare metalice
FR Set de graisseurs métriques
IT Set grasso capezzoli
ES Engrasador
CN 黄油嘴组套

110
PCS

METRIC
METRYCZNY



M6x1 (60 PCS), M6x1 45° (5 PCS), M6x1 90° (5 PCS), M8x1 (10 PCS), M8x1 45° (5 PCS), M8x1 90° (5 PCS), M10x1 (10 PCS), M10x1 45° (5 PCS), M10x1 90° (5 PCS)

YATO  
YT-06888 5/20

EN Aluminium rivet assortment
PL Zestaw aluminiowych nitów zrywalnych
DE Aluminium Blindnieten Sortiment
RU Набор закленок
CZ Sada hliníkové nity
HU Csőves alumínium szegecsek

RO Set popnitur
FR Rivets tubulaires en aluminium
IT Set di rivetto alluminio
ES Remaches tubulares de aluminio
CN 铆钉

400
PCS

MIX

AI



2.4, 3.2, 4.0, 4.8 mm

YATO  
YT-36420 5/20

EN Splint pin assortment
PL Zestaw zawleczek prostych
DE Splinte Sortiment
RU Набор шплинтов
CZ Set závlačky
HU Sasszeg készlet

RO Cuie spintecate mici
FR Goupilles - goupille fendue
IT Set di perni
ES Dividir cotter pinos
CN 开口销

555
PCS

MIX



1.6x25 mm, 2.4x25 mm, 2.4x38 mm, 3.2x32 mm, 3.2x50 mm, 4.0x64 mm

YATO  
YT-06873 5/10

EN Splint pin assortment
 PL Zestaw zawleczek prostych
 DE Splinte Sortiment
 RU Набор шплинтов
 CZ Set závlačky
 HU Sasszeg készlet

RO Cuie spintecate mici
 FR Goupilles - goupille fendue
 IT Set di perni
 ES Dividir colter pinos
 CN 开口销组套

1000
PCS

MIX

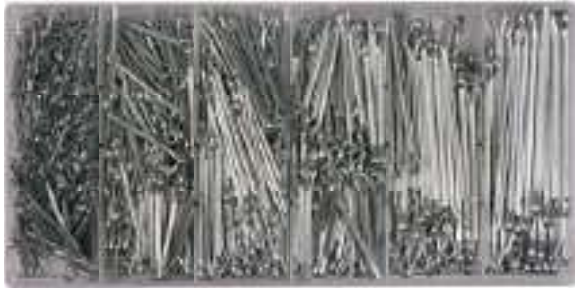

1.5x25 mm, 2.4x25 mm, 2.4x38 mm, 3.0x32 mm, 3.0x50 mm, 4.0x60 mm

YATO  6/12
 YT-06885

EN E-ring circlips assortment
 PL Zestaw zawleczek typu „E”
 DE E-Sicherungsringe Sortiment
 RU Набор Э-образных стопорных колец
 CZ Otevřeni pojistný kroužek
 HU „E” klip választék készlet

RO Set inele de siguranta tip „E”
 FR „E” clip assortment kit
 IT Set di spine tipo „E”
 ES E-ring anillo de retención variedad
 CN 卡簧

300
PCS

1.5-22
mm



1.5 mm, 3 mm, 5 mm, 6 mm, 10 mm, 12 mm, 15 mm, 19 mm, 22 mm

YATO  25
 YT-06884

EN Metal tiller tin pin assortment
 PL Zestaw zawleczek i sworzni z lbem i otworami
 DE Set Splinte und Bolzen mit Kopf und Löchern
 RU Набор шплинтов и болтов с головкой и отверстиями
 CZ Sada závlaček a šroubů s hlavou a olvory
 HU Sasszeg és fejes, nyílásos csapszeg készlet

RO Set bolturi cu siguranta
 FR Jeu de goupilles et d'axes avec têtes et des trous
 IT Kit di copiglie e perni con testa e fori
 ES Juego de pasadores y pernos con cabeza y aberturas
 CN 八孔销

56
PCS

8-13
mm

MIX

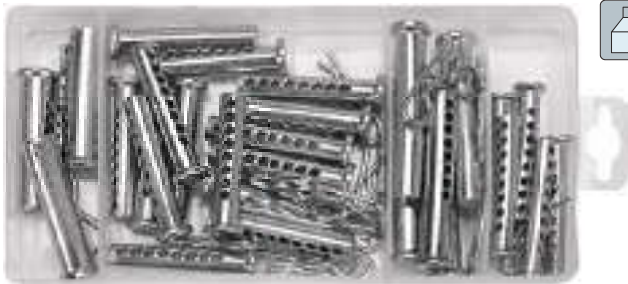

8x50 mm (5 PCS), 9.5x50 mm (15 PCS), 11x64 mm (5 PCS), 13x50 mm (3 PCS), Pins / Zawleccki: 2x30 mm (5 PCS), 2.5x40 mm (15 PCS), 2.5x40 mm (5 PCS), 3x44 mm (3 PCS)

YATO  20
 YT-06874

EN Axle wave washer assortment
 PL Zestaw zabezpieczeń osiowych sprężystych
 DE Axialer Federschutzsatz
 RU Замок осевой пружинный
 CZ Sada axiálních pružinových závlaček
 HU Rugós tengelybiztosító gyűrű

RO Set saibe axe
 FR Jeu de protections axiales à ressorts
 IT Kit di protezioni assiali a molla
 ES Juego de sujeciones rápidas elásticas para ejes
 CN 轴承夹片

260
PCS

MIX

65Mn



M3x10 mm (30 PCS), M4x11.5 mm (30 PCS), M5x14 mm (40 PCS), M6x16 mm (50 PCS), M8x18 mm (50 PCS), M10x20.5 mm (40 PCS), M12x26 mm (20 PCS)

YATO  24
 YT-06860

EN Linch-pins assortment
 PL Zestaw zawleczek z kółkiem
 DE Klappsplint Sortiment
 RU Набор шплинтов с кольцом
 CZ Kolik pojistný
 HU Rugos biztosítoszeg készlet

RO Set pini pt. securizare
 FR Assortiment goupille clip
 IT Set di perni dalla ruota
 ES Pasador clip
 CN 弹性销组套

50
PCS

MIX



Ø 4.5x36 mm, Ø 6.0x45 mm, Ø 8.0x45 mm, Ø 11.0x45 mm

YATO  6/12
 YT-06787

EN Single ear hose clamp assortment
 PL Zestaw obejm zaciskowych z uchem
 DE 1-Ohr-Schellensatz
 RU Зажимы для шлангов с ушком
 CZ Jednoho ucha hadicové svorky
 HU Fűles szorítóbilincs készlet

RO Coliere metalice pt. furtun
 FR Jeu de colliers de serrage à oreille
 IT Set di fascette di fissaggio con orecchio
 ES Juego de abrazaderas de una oreja
 CN 卡箍套装

170
PCS

MIX

SS304
STAINLESS STEEL
SIAL NERZUEVENIA



5.8-7 mm (20 PCS), 7.3-9 mm (20 PCS), 8.8-10.5 mm (20 PCS), 10.8-13.3 mm (20 PCS), 12-14.5 mm (20 PCS), 12.3-14.8 mm (20 PCS), 14.5-17 mm (20 PCS), 16-19.2 mm (15 PCS), 17.8-21 mm (15 PCS)

YATO  24
 YT-067842

EN Hose clamp assortment
PL Zestaw obejm ślimakowych
DE Schlauchschelle Sortiment
RU Набор хомутов
CZ Spony stahovac na hadice sada
HU Tömélbilincs csőszerelés szett

RO Coliere furtun
FR Colliers de serrage universels
IT Fascetta assortimento
ES Manguera helicoidal instalación de tuberías abrazadera conjunto
CN 喉箍

26
PCS

16-40
mm

MIX



16, 22, 25, 28, 35, 40 mm

YATO

YT-06782



5/20

EN Steel and rubber hose clamps
PL Zestaw opasek zaciskowych metalowo-gumowych
DE Gummierete Schlauchschellen Sortiment
RU Хомуты сантехнические
CZ Kabelové příchytky s gumou
HU Gumbetétes szorítóbilincs készlet

RO Coliere de furtun din otel si cauciuc
FR Colliers de serrage en métal et caoutchouc
IT Set di fascette di fissaggio di metallo e gomma
ES Abrazaderas con goma
CN 单耳卡箍套装

18
PCS

MIX



6 mm (8 PCS), 8 mm (4 PCS), 10 mm (2 PCS), 13 mm (2 PCS), 16 mm (2 PCS)

YATO

YT-067833



54

EN Double ear hose clamp assortment
PL Zestaw obejm zaciskowych z uszami
DE 2-Ohr-Schellensatz
RU Набор хомутов с проушинами
CZ Dvojité ucho hadicové svorky
HU Füles szorítókészlet

RO Set de me furtun
FR Jeu de serre-câbles à oreilles
IT Set di fascette di fissaggio con orecchie
ES Set de abrazaderas con orejetas
CN 双耳卡箍套装

175
PCS

MIX



5-7 mm (25 PCS), 7-9 mm (25 PCS), 9-11 mm (25 PCS), 11-13 mm (20 PCS), 13-15 mm (20 PCS), 15-18 mm (20 PCS), 17-20 mm (15 PCS), 20-23 mm (15 PCS), 23-27 mm (10 PCS)

YATO

YT-06784



10

EN Hose clamp assortment
PL Zestaw obejm skręcanych do przewodów
DE Schlauchschellen-Set
RU Набор винтовых зажимов для кабелей
CZ Sada šroubovaných svorek do hadic
HU Vezetékbilincs készlet

RO Set coliere pt. furtun
FR Jeu de supports à visser pour conducteurs
IT Kit di clip fermacavi
ES Juego de abrazaderas atornillables para cables
CN 喉箍

30
PCS

MIX

6-16
mm



6-8 mm (7 PCS), 7-9 mm (7 PCS), 8-10 mm (5 PCS), 9-11 mm (5 PCS), 10-12 mm (3 PCS), 14-16 mm (3 PCS)

YATO

YT-06783



24

EN Steel and rubber hose clamps
PL Zestaw opasek zaciskowych metalowo-gumowych
DE Gummierete Schlauchschellen Sortiment
RU Хомуты сантехнические
CZ Kabelové příchytky s gumou
HU Gumbetétes szorítóbilincs készlet

RO Coliere de furtun din otel si cauciuc
FR Colliers de serrage en métal et caoutchouc
IT Set di fascette di fissaggio di metallo e gomma
ES Abrazaderas con goma
CN 单耳卡箍套装

52
PCS

MIX



6 mm (12 PCS), 8 mm (10 PCS), 10 mm (10 PCS), 13 mm (8 PCS), 16 mm (8 PCS), 19 mm (4 PCS)

YATO

YT-067834



22

EN External / internal circlip assortment
PL Zestaw pierścieni Seeger
DE Seeger-Sicherungsringe
RU Набор стопорных колец
CZ Sada vnitřní / vnější kroužky
HU Seeger gyűrű készlet

RO Set sigurante tip inel alezaj
FR Set de bagues Seeger
IT Set di anelli Seeger
ES Set de anillos Seeger
CN 卡簧

225
PCS

MIX



Internal / Wewnętrzne: Ø 11, 13, 14, 16, 19, 20 mm; External / Zewnętrzne: Ø 6, 8, 9, 11, 13, 14, 16, 19, 20, 22, 25, 32 mm

YATO

YT-06882



5/20

EN External circlip assortment
 PL Zestaw pierścieni Segera zewnętrznych
 DE Aussen-Seegerring Sortiment
 RU Набор стопорных колец
 CZ Sada pojistné kroužky
 HU Külső seeger-gyűrű készlet

RO Set sigurante tip inel alezaj
 FR Set de bagues Seeger
 IT Set di anelli Seeger
 ES Set de anillos Seeger
 CN 外置挡圈

300
PCS



Ø 3, 4, 5, 6, 8, 9, 11, 12, 13, 14, 15, 19, 20, 22, 25, 26, 28, 32 mm

YATO

YT-06880 **5/20**

EN Internal circlip assortment
 PL Zestaw pierścieni Segera wewnętrznych
 DE Innen-Seegerring Sortiment
 RU Набор стопорных колец
 CZ Sada pojistné kroužky
 HU Belső seeger-gyűrű készlet

RO Set sigurante tip inel alezaj
 FR Set de bagues Seeger
 IT Set di anelli Seeger
 ES Set de anillos Seeger
 CN 内置挡圈

300
PCS



Ø 3, 4, 5, 6, 8, 9, 11, 12, 13, 14, 15, 19, 20, 22, 25, 26, 28, 32 mm

YATO

YT-06881 **5/20**

EN Feather key assortment
 PL Zestaw klinów do kół pasowych
 DE Keilset für Riemenscheiben
 RU Комплект клиньев для шкивов
 CZ Sada klinů pro vodící kládky
 HU Szíjtárcsa ékkészlet

RO Set pene
 FR Jeu de cales pour poulies
 IT Set di linguette per pulegge
 ES Juego de cuñas de polea
 CN 平键

60
PCS

MIX



3x3x20 mm (4 PCS), 3x3x25 mm (4 PCS), 8x10x30 mm (5 PCS), 5x5x20 mm (5 PCS), 8x7x30 mm (5 PCS), 5x5x25 mm (5 PCS), 8x7x40 mm (5 PCS), 5x5x30 mm (5 PCS), 6x6x20 mm (5 PCS), 10x8x40 mm (5 PCS), 6x6x30 mm (5 PCS), 6x6x40 mm (5 PCS), 8x12x40 mm (2 PCS)

YATO

YT-06793 **24**

EN Feather keys assortment
 PL Zestaw klinów półokrągłych
 DE Sortiment Federkeile
 RU Шпонки полукруглые
 CZ Sada klinů polokruhových
 HU Ives hornyok biztosítására

RO Set pene disc pt. imbinari arbore
 FR Aspérule clés assortiment
 IT Set di cunei semicircolari
 ES Surtido de chavetas media luna
 CN 键销组套

80
PCS

MIX



3.0x5.0x13 mm, 3.0x6.5x16 mm, 4.0x5.0x13 mm, 4.0x6.5x16 mm, 4.0x7.5x19 mm, 5.0x7.5x19 mm, 5.0x9.0x22 mm, 6.0x9.0x22 mm

YATO

YT-06790 **5/20**

EN Steel ball assortment
 PL Zestaw kulek stalowych
 DE Stahlkugeln-Set
 RU Набор стальных шариков
 CZ Sada ocelových kuliček
 HU Acél golyókészlet

RO Set bile pt. rulmenti
 FR Jeu de billes en acier
 IT Set di sfere d'acciaio
 ES Juego de bolas de acero
 CN 轴承钢钢珠组套

470
PCS

MIX

BEARING
 STEEL
 STAL
 ŁOŻYSKOWA

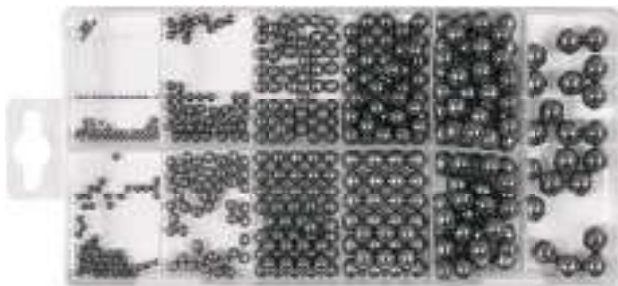

3/32" (2.4 mm, 50 PCS), 1/8" (3.2 mm, 50 PCS), 5/32" (4.0 mm, 50 PCS), 3/16" (4.8 mm, 50 PCS), 7/32" (5.6 mm, 50 PCS), 1/4" (6.3 mm, 50 PCS), 9/32" (7.1 mm, 50 PCS), 5/16" (7.9 mm, 30 PCS), 11/32" (8.7 mm, 50 PCS), 3/8" (9.5 mm, 20 PCS), 13/32" (10.3 mm, 20 PCS)

YATO

YT-06680 **5/20**

EN Socket head set screw assortment metric
 PL Zestaw śrub imbusowych bez łba
 DE Sortiment Madenschrauben, metrisch
 RU Набор винтов установочных с плоским концом
 CZ Šroub stavěcí, plochý konec, bez úpravy
 HU Set menetes sasszegekkel

RO Set splituri fi letate
 FR Set clavettes de vis
 IT Set di viti esagonali senza testa
 ES Conjunto de tornillo chavetas
 CN 螺钉组套

160
PCS

MIX

METRIC
 METRYCZNY



3x5 mm, 4x5 mm, 5x6 mm, 6x6 mm, 6x6 mm F, 6x10 mm, 8x10 mm, 8x10 mm F, 8x12 mm, 10x10 mm, 10x10 mm F, 10x12 mm

YATO

YT-06777 **5/20**

EN Rubber grommet assortment
PL Zestaw przelotek gumowych
DE Gummi-Durchgangs-Tüllen Sortiment
RU Набор резиновых втулок
CZ Gumové průchodka
HU Gumi grommet készlet

RO Presetupa cauciuc pt. cablu
FR Coffret passe-cloison caoutchouc
IT Gommino angello
ES Caja surtido de pasamuros de goma
CN 垫圈组套

180
PCS

MIX

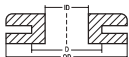

6,3 mm (D=6,3 mm, ID=3,0 mm, OD=8,0 mm; 40 PCS), 7,9 mm (D=7,9 mm, ID=5,0 mm, OD=10,0 mm; 40 PCS), 9,5 mm (D=9,5 mm, ID=6,0 mm, OD=13,0 mm; 40 PCS), 11 mm (D=11,0 mm, ID=9,0 mm, OD=15,0 mm; 25 PCS), 12,7 mm (D=12,7 mm, ID=11,0 mm, OD=15,0 mm; 20 PCS), 15,8 mm (D=15,8 mm, ID=12,0 mm, OD=19,0 mm; 5 PCS), 22 mm (D=22,0 mm, ID=15,0 mm, OD=26,0 mm; 5 PCS), 25,4 mm (D=25,4 mm, ID=17,0 mm, OD=32,0 mm; 5 PCS)

YATO

YT-06878

5/20

EN O-ring assortment
PL Zestaw O-ringów gumowych
DE O-Ring Sortiment
RU Набор резиновых прокладок
CZ Sada gumových o-kroužků
HU O gyűrű készlet

RO Garnituri din cauciuc
FR Set d'o-rings en caoutchouc
IT Set guarnizioni O-ring
ES Kit de junta tórica
CN O型圈组套

225
PCS

HEAT
RESISTANT
TEMPERATURE-
RESISTANT



3x1 mm (20 PCS), 4x1 mm (20 PCS), 4,5x2 mm (20 PCS), 5x2 mm (20 PCS), 6x2 mm (20 PCS), 6x2,5 mm (20 PCS), 6x3 mm (20 PCS), 7x2 mm (20 PCS), 8x2 mm (20 PCS), 9x2 mm (5 PCS), 10x2 mm (5 PCS), 12x3 mm (5 PCS), 13x3 mm (5 PCS), 14x2,5 mm (5 PCS), 17x2,5 mm (5 PCS), 18x4 mm (5 PCS), 20x2 mm (5 PCS), 22x2 mm (5 PCS)

YATO

YT-06877

5/20

EN O-Rings assortment for air conditioning
PL Zestaw O-ringów do klimatyzacji
DE O-Ring für Klimaanlage
RU Комплект прокладок для кондиционера
CZ Gumový kroužek set klimatizace
HU Gumi gyűrű készlet légkondicionáló

RO Inele pt. aer condiționat
FR Cercle en caoutchouc boîte de kit combinaison
IT O-Ring assortimento per l'aria condizionata
ES Kit círculo caucho combinación caja
CN O型圈组套

270
PCS

MIX

HNBR



Ø 5,29x1,78 mm (20 PCS), Ø 6,07x1,78 mm (20 PCS), Ø 6,8x1,9 mm (20 PCS), Ø 7,65x1,78 mm (20 PCS), Ø 7,8x1,9 mm (20 PCS), Ø 8x2 mm (20 PCS), Ø 8,8x1,9 mm (20 PCS), Ø 10,82x1,78 mm (15 PCS), Ø 10,77x2,62 mm (15 PCS), Ø 11x2 mm (15 PCS), Ø 12x2 mm (15 PCS), Ø 13,9x1,8 mm (10 PCS), Ø 13,95x2,62 mm (10 PCS), Ø 10x2 mm (10 PCS), Ø 15x2 mm (10 PCS), Ø 17x2 mm (10 PCS), Ø 17,17x1,78 mm (10 PCS), Ø 17,04x3,53 mm (10 PCS)

YATO

YT-06879

6/24

EN Roll pin assortment
PL Zestaw kółków sprężystych
DE Hohlspannstifte Spannsteife Sortiment
RU Набор штифтов с пружиной
CZ Pružné válčové kolíky se štěrbinou
HU Rugalmas hengeres csapok a nyílásba

RO Set splinturi elastice
FR Ressorts à rouleaux
IT Perno del rullo assortimento
ES Acero pasador elástico
CN 弹性销

315
PCS

MIX



1,5x5 mm, 1,5x8 mm, 1,5x20 mm, 2x6 mm, 2x12 mm, 2x25 mm, 2,5x16 mm, 2,5x25 mm, 2,5x30 mm, 3x16 mm, 3x25 mm, 3x30 mm, 4x16 mm, 4x25 mm, 4x40 mm, 5x16 mm, 5x25 mm, 5x30 mm, 5,5x16 mm, 5,5x30 mm, 5,5x45 mm, 6x16 mm, 6x30 mm, 6x45 mm, 8x20 mm, 8x40 mm, 8x50 mm, 10x20 mm, 10x40 mm, 10x50 mm

YATO

YT-06785

5/20

EN O-Rings assortment for air conditioning
PL Zestaw O-ringów do klimatyzacji
DE O-Ring für Klimaanlage
RU Комплект прокладок для кондиционера
CZ Gumový kroužek set klimatizace
HU Gumi gyűrű készlet légkondicionáló

RO Inele pt. aer condiționat
FR Cercle en caoutchouc boîte de kit combinaison
IT O-Ring assortimento per l'aria condizionata
ES Kit círculo caucho combinación caja
CN 氢化丁晴密封圈

225
PCS

MIX

HNBR



3x1 mm (20 PCS), 4x1 mm (20 PCS), 4,5x2 mm (20 PCS), 5x2 mm (20 PCS), 6x2 mm (20 PCS), 6x2,5 mm (20 PCS), 6x3 mm (20 PCS), 7x2 mm (20 PCS), 8x2 mm (20 PCS), 9x2 mm (5 PCS), 10x2 mm (5 PCS), 12x3 mm (5 PCS), 13x3 mm (5 PCS), 14x2,5 mm (5 PCS), 17x2,5 mm (5 PCS), 18x4 mm (5 PCS), 20x2 mm (5 PCS), 22x2 mm (5 PCS)

YATO

YT-068791

5/20

EN O-ring assortment
PL Zestaw O-ringów gumowych
DE O-Ring Sortiment
RU Набор резиновых прокладок
CZ Sada gumových o-kroužků
HU O gyűrű készlet

RO Garnituri din cauciuc
FR Set d'o-rings en caoutchouc
IT Set guarnizioni O-ring
ES Kit de junta tórica
CN O型圈

419
PCS

MIX

NBR

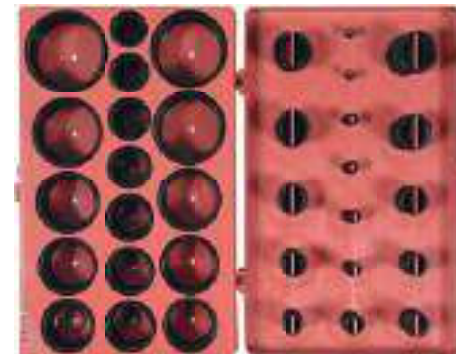

3x1,5 mm, 4,4x2 mm, 5x2 mm, 7x1,5 mm, 10x1,5 mm, 10x2,5 mm, 11x2,5 mm, 13x1,5 mm, 13x2,5 mm, 14x2,5 mm, 16x2,5 mm, 18x2,5 mm, 19x2,5 mm, 21x2,5 mm, 22x2,5 mm, 18x3,5 mm, 20x3,5 mm, 22x3,5 mm, 23,5x3,5 mm, 25x3,5 mm, 26,5x3,5 mm, 28x3,5 mm, 30x3,5 mm, 31x3,5 mm, 33x3,5 mm, 34,5x3,5 mm, 36x3,5 mm, 38x3,5 mm, 41x3,5 mm, 44x3,5 mm, 47x3,5 mm, 50x3,5 mm

YATO

YT-06876

5/20

EN Electrical clip assortment
 PL Zestaw złącz elektrycznych - krokodyliki
 DE Krokodil-Klemmen-Kortiment
 RU Набор разъемов - крокодил
 CZ Terminal alligator krokodil příchyték
 HU Krokodil csipesz készlet

RO Sortiment cleme crocodil
 FR Assortiment pinces crocodile
 IT Set di perni per misure e prove
 ES Crocodile clip
 CN 夹头组套

28
PCS

MIX



50, 55, 60, 65, 70, 80 mm

YATO

YT-06870

5/20

EN Terminal assortment
 PL Zestaw złącz elektrycznych
 DE Kabelschuh-Set
 RU Набор электрических клемм
 CZ Sada elektrických konektorů
 HU Elektromos csatlakozókészlet

RO Set papuci auto
 FR Jeu de cosses de câbles
 IT Kit di connettori elettrici
 ES Juego de conectores eléctricos
 CN 接线端子

250
PCS

MIX



Connector blue male / Złącze niebieskie męskie: 6.4 mm (1.5-2.5mm; 50 PCS), Connector blue female / Złącze niebieskie żeńskie: 6.4 mm (1.5-2.5 mm; 50 PCS), Connector red male / Złącze czerwone męskie: 6.4 mm (0.5-1.5 mm; 50 PCS), Connector red female / Złącze czerwone żeńskie: 6.4 mm (0.5-1.5 mm; 50 PCS), Connector tube red / Złącze rurowe czerwone: (0.5-1.5 mm; 25 PCS), Connector tube blue / Złącze rurowe niebieskie: (0.5-1.5 mm; 25 PCS)

YATO

YT-068911

60

EN Terminal assortment
 PL Zestaw złącz elektrycznych
 DE Kabelschuh-Set
 RU Набор электрических клемм
 CZ Sada elektrických konektorů
 HU Elektromos csatlakozókészlet

RO Set papuci auto
 FR Jeu de cosses de câbles
 IT Kit di connettori elettrici
 ES Juego de conectores eléctricos
 CN 接线端子

360
PCS

MIX



⊙ Ø5 mm - 2 mm2 (30 PCS), Ø6 mm - 2 mm2 (20 PCS), ⊞ 2 mm2 (25 PCS);
 Ø9.5 mm - 2 mm2 (20 PCS), Ø5 mm - 5.5 mm2 (20 PCS), ⊞ 2 mm2 (35 PCS);
 Ø6 mm - 5.5 mm2 (15 PCS), Ø9.5 mm - 5.5 mm2 (15 PCS); ⊞ 2 mm2 (10 PCS);
 ⊞ 1.25 mm2 (40 PCS), 2 mm2 (30 PCS), 5.5 mm2 (15 PCS); ⊞ 2 mm2 (35 PCS)
 ⊞ Ø5 mm - 2 mm2 (30 PCS), Ø5 mm - 5.5 mm2 (20 PCS);

YATO

YT-06890

12

EN Terminal assortment
 PL Zestaw złącz elektrycznych
 DE Kabelschuh-Set
 RU Набор электрических клемм
 CZ Sada elektrických konektorů
 HU Elektromos csatlakozókészlet

RO Set papuci auto
 FR Jeu de cosses de câbles
 IT Kit di connettori elettrici
 ES Juego de conectores eléctricos
 CN 接线端子

160
PCS

MIX



⊙ Ø4 mm (8 PCS), Ø4 mm (10 PCS), Ø5 mm (4 PCS), Ø5 mm (10 PCS), Ø6 mm (10 PCS), Ø8 mm (4 PCS), Ø10 mm (4 PCS);
 ⊞ 0.25-1.5 mm2 (12 PCS), 1.5-2.5 mm2 (18 PCS), 4-6 mm2 (12 PCS);
 ⊞ Ø4 mm (10 PCS);
 ⊞ 1.5-2.5 mm2 (10 PCS);
 ⊞ 1.5-2.5 mm2 (10 PCS), 4-6 mm2 (5 PCS);
 ⊞ 1.5-2.5 mm2 (10 PCS);
 ⊞ 1.5-2.5 mm2 (10 PCS), 4-6 mm2 (5 PCS);
 ⊞ 0.25-1.5 mm2 (4 PCS), 1.5-2.5 mm2 (4 PCS)

YATO

YT-06891

24

EN Terminal assortment
 PL Zestaw złącz elektrycznych
 DE Kabelschuh-Set
 RU Набор электрических клемм
 CZ Sada elektrických konektorů
 HU Elektromos csatlakozókészlet

RO Set papuci auto
 FR Jeu de cosses de câbles
 IT Kit di connettori elettrici
 ES Juego de conectores eléctricos
 CN 接线端子

240
PCS

MIX



Connector red female / Złącze czerwone żeńskie: 6.4 mm (0.5-1.5 mm; 20 PCS), Connector red full female / Złącze czerwone pełne żeńskie: 4.8 mm (0.5-1.5 mm; 20 PCS), Connector red male / Złącze czerwone męskie: 4.8 mm (0.5-1.5 mm; 20 PCS), Connector red male male / Złącze czerwone męsko-męskie: 6.4 mm (0.5-1.5 mm; 40 PCS), Connector blue female / Złącze niebieskie żeńskie: 6.4 mm (1.5-2.5 mm; 20 PCS), Connector blue full female / Złącze niebieskie pełne żeńskie: 6.4 mm (1.5-2.5 mm; 20 PCS), Connector blue male / Złącze niebieskie męskie: 6.4 mm (1.5-2.4 mm; 20 PCS), Connector blue female / Złącze niebieskie żeńskie: 4.8 mm (1.5-2.5 mm; 20 PCS)

YATO

YT-068912

60

EN Terminal assortment
 PL Zestaw złącz elektrycznych
 DE Kabelschuh-Set
 RU Набор электрических клемм
 CZ Sada elektrických konektorů
 HU Elektromos csatlakozókészlet

RO Set papuci auto
 FR Jeu de cosses de câbles
 IT Kit di connettori elettrici
 ES Juego de conectores eléctricos
 CN 接线端子

450
PCS

MIX



Connector female / Złącze żeńskie: 2.8 mm, 4.8 mm, 6.4 mm (x50 PCS);
 Connector male / Złącze męskie: 2.8 mm, 4.8 mm, 6.4 mm (x50 PCS);
 Connector with hole / Złącze z oczkiem: Ø3.2 mm, Ø5.2 mm, Ø8.2 mm (x50 PCS)

YATO

YT-068683

24

EN Terminal assortment
PL Zestaw złączy elektrycznych
DE Kabelschuh-Set
RU Набор электрических клемм
CZ Sada elektrických konektorů
HU Elektromos csatlakozókészlet

RO Set papuci auto
FR Jeu de cosSES de câbles
IT Kit di connettori elettrici
ES Juego de conectores eléctricos
CN 接线端子



EN Terminal assortment
PL Zestaw złączy elektrycznych
DE Kabelschuh-Set
RU Набор электрических клемм
CZ Sada elektrických konektorů
HU Elektromos csatlakozókészlet

RO Set papuci auto
FR Jeu de cosSES de câbles
IT Kit di connettori elettrici
ES Juego de conectores eléctricos
CN 接线端子

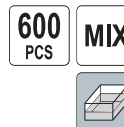

Connector female / Złącze żeńskie: 2.8 mm, 4.8 mm, 6.4 mm (x100 PCS); Connector male / Złącze męskie: 2.8 mm, 4.8 mm, 6.4 mm (x100 PCS)



PBDD 1-250, PBDD 2-250, PBDD 5-250, FDFD 5-250, RV 5.5-4, RV 5.5-5, RV 5.5-6 (x10 PCS); E1008 red / czerwone, E1508 red / czerwone, E2508 blue / niebieskie (x50 PCS); TE1008 red / czerwone, TE1508 red / czerwone, TE2510 red / czerwone, MDD 1-250, MDD 2-250 (x20 PCS); MDD 5-250, BV 5.5, FDD 5-250 (x10 PCS); FDFD 1-250, FDFD 2-250, RV 1.25-5, RV 2-5, BV 2 (x15 PCS); RV 1.25-3, RV 1.25-4, RV 2-3, RV 2-4 (x30 PCS); FDD 1-250, FDD 2-250 (x20 PCS)



EN Insulated ferrules assortment
PL Zestaw końcówek i konektorów kablowych
DE Kabelschuh- und Verbinder-Set
RU Набор кабельных наконечников и коннекторов
CZ Sada kabelových koncovek a konektorů
HU Végződések és csatlakozókészlet

RO Set conectori
FR Jeu de cosSES de câbles
IT Set di terminali e connettori per cavi
ES Set de puntas y conectores de cable
CN 欧式接线端子



0.5 mm (50 PCS), 0.75 mm (50 PCS), 1 mm (100 PCS), 1.5 mm (250 PCS), 2.5 mm (150 PCS), 4 mm (50 PCS), 6 mm (25 PCS), 10 mm (10 PCS)



EN Terminal assortment
PL Zestaw złączy elektrycznych
DE Kabelschuh-Set
RU Набор электрических клемм
CZ Sada elektrických konektorů
HU Elektromos csatlakozókészlet

RO Set papuci auto
FR Jeu de cosSES de câbles
IT Kit di connettori elettrici
ES Juego de conectores eléctricos
CN 接线端子

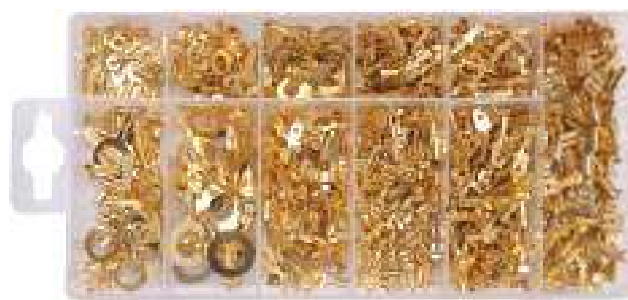
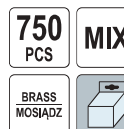

Connector female / Złącze żeńskie: 2.8 mm, 4.8 mm, 6.4 mm (x100 PCS); Connector male / Złącze męskie: 2.8 mm, 4.8 mm, 6.4 mm (x100 PCS); Connector with hole / Złącze z oczkiem: Ø3.2 mm, Ø5.2 mm, Ø6.2 mm, Ø8.2 mm, Ø10.5 mm (x30 PCS)



EN Crimp bootlace ferrules assortment
PL Zestaw końcówek kablowych
DE Aderendhülsen Set
RU Набор кабельных наконечников
CZ Sada kabelových koncovek
HU Kábelsaru készlet

RO Kit cepete sertizat cabluri fara izolare
FR Jeu de cosSES de câbles
IT Set di terminali
ES Juego casquillos de cable
CN 接线端子

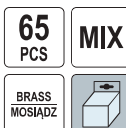

SC6-6 (15 PCS), SC6-8 (10 PCS), SC10-6 (10 PCS), SC10-8 (10 PCS), SC16-6 (5 PCS), SC16-8 (5 PCS), SC25-6 (5 PCS), SC25-8 (5 PCS)

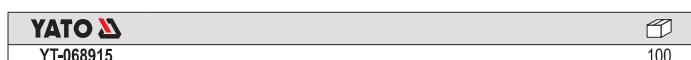

EN Crimp bootlace ferrules assortment
PL Zestaw końcówek kablowych
DE Aderendhülsen Set
RU Набор кабельных наконечников
CZ Sada kabelových koncovek
HU Kábelsaru készlet

RO Kit cepete sertizat cabluri fara izolare
FR Jeu de cosSES de câbles
IT Set di terminali
ES Juego casquillos de cable
CN 接线端子



0.5 mm (ferrule length / długość okucia: 6 mm), 0.75 mm (ferrule length / długość okucia: 6 mm), 1 mm (ferrule length / długość okucia: 6 mm), 1.5 mm (ferrule length / długość okucia: 7 mm), 2.5 mm (ferrule length / długość okucia: 7 mm) (x200 PCS)

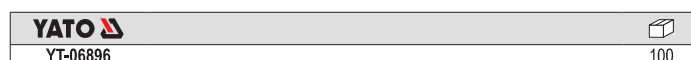

EN Insulated ferrules assortment
 PL Zestaw końcówek i konektorów kablowych
 DE Kabelschutz- und Verbinders-Set
 RU Набор кабельных наконечников и коннекторов
 CZ Sada kabelových koncovek a konektorů
 HU Végződés és csatlakozókészlet

RO Set conectori
 FR Jeu de cosses de câbles
 IT Set di terminali e connettori per cavi
 ES Set de puntas y conectores de cable
 CN 欧式接线端子

1200
PCS

MIX





E1012 red / czerwone (25 PCS), E6012 green / zielone (25 PCS), E1008 red / czerwone (200 PCS), E2508 blue / niebieskie (250 PCS), E4010 grey / szare (50 PCS), E1508 black / czarne (250 PCS), E0508 white / białe (200 PCS), E7508 grey / szare (200 PCS)

YATO

YT-068914 20

EN Terminal connectors
 PL Zestaw szybkozłączy elektrycznych
 DE Kabelschuhe schnellkupplung kabelklemme
 RU Набор экспресс-клемм
 CZ Rychlopřipojky elektrických konektorů
 HU Gyors csatlakozó

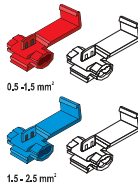
RO Conector rapid pt. auto
 FR Connecteur rapide
 IT Connettori terminali
 ES Conector rapido electrico
 CN 连接片组套



50
PCS

MIX

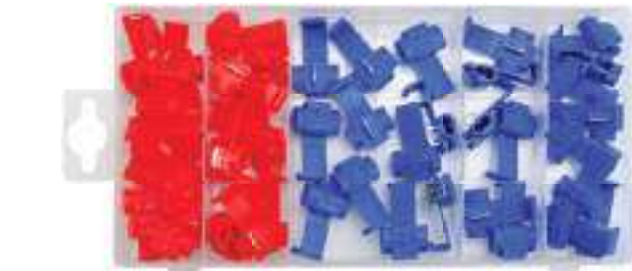
0.5-1.5 mm² (25 PCS), 1.5-2.5 mm² (25 PCS)

YATO

YT-06868 5/20

EN Heat-shrink tubing set
 PL Zestaw koszulek termokurczliwych
 DE Schrumpfschlauch-Set
 RU Набор термоусадочных трубок
 CZ Sada smršťovacích bužírek
 HU Zsugorcső készlet

RO Set tuburi termocontractabile
 FR Jeu de gaines thermorétractables
 IT Kit guaine termorestringenti
 ES Kit de tubos termorretráctiles
 CN 热收缩管

100
PCS

MIX

max °C
125



Ø1.5x100 mm (30 PCS), Ø2.5x100 mm (30 PCS), Ø4x100 mm (20 PCS), Ø6x100 mm (10 PCS), Ø10x100 mm (6 PCS), Ø13x100 mm (4 PCS)

YATO

YT-068667 24

EN Crimping tool and terminals set
 PL Zestaw złączy elektrycznych z zaciskarką
 DE Kabelschuh-Set mit Crimpzange
 RU Набор изолированных наконечников с пресс-клещами
 CZ Sada elektrických konektorů s kleštěmi
 HU Elektromos csatlakozókészlet kímélő fogóval
 RO Set sertizat conectori izolati
 FR Jeu de cosses de câbles avec pince à sertir
 IT Kit di connettori elettrici con pinze
 ES Juego de conectores eléctricos con crimpadora
 CN 冷压工具组套

551
PCS

0.5-6.0
mm²

MIX



0.5-1.5 mm² (90 PCS), 1.5-2.5 mm² (90 PCS), 2.5-3.5 mm² (30 PCS);
 0.5-1.5 mm² (70 PCS), 1.5-2.5 mm² (70 PCS), 2.5-3.5 mm² (30 PCS);
 0.5-1.5 mm² (30 PCS), 1.5-2.5 mm² (30 PCS);
 0.5-1.5 mm² (30 PCS), 1.5-2.5 mm² (30 PCS)

YATO

YT-068920 0.5-6 22-10 10

EN Heat-shrink tubing set
 PL Zestaw koszulek termokurczliwych
 DE Schrumpfschlauch-Set
 RU Набор термоусадочных трубок
 CZ Sada smršťovacích bužírek
 HU Zsugorcső készlet

RO Set tuburi termocontractabile
 FR Jeu de gaines thermorétractables
 IT Kit guaine termorestringenti
 ES Kit de tubos termorretráctiles
 CN 热收缩管

100
PCS

MIX

max °C
125



Ø1.5x100 mm (30 PCS), Ø2.5x100 mm (30 PCS), Ø4x100 mm (20 PCS), Ø6x100 mm (10 PCS), Ø10x100 mm (6 PCS), Ø13x100 mm (4 PCS)

YATO

YT-068661 24

EN Heat-shrink tubing set
 PL Zestaw koszulek termokurczliwych
 DE Schrumpfschlauch-Set
 RU Набор термоусадочных трубок
 CZ Sada smršťovacích bužírek
 HU Zsugorcső készlet

RO Set tuburi termocontractabile
 FR Jeu de gaines thermorétractables
 IT Kit guaine termorestringenti
 ES Kit de tubos termorretráctiles
 CN 热收缩管

127
PCS

MIX

max °C
125

max
600V



Ø2x40 mm, Ø2.5x40 mm, Ø3.5x40 mm, Ø5x40 mm, Ø7x80 mm, Ø10x80 mm, Ø13x85 mm

YATO

YT-06866 5/20

EN Heat-shrink tubing set
PL Zestaw koszulek termokurczliwych
DE Schrumpfschlauch-Set
RU Набор термоусадочных трубок
CZ Sada smršťovacích bužírek
HU Zsugorcső készlet

RO Set tuburi termocontractabile
FR Jeu de gaines thermorétractables
IT Kit guaine termorestringenti
ES Kit de tubos termorretráctiles
CN 热收缩管

128
PCS

MIX

max °C
125



Ø2.5x8 mm (40 PCS), Ø3.5x80 mm (32 PCS), Ø5x80 mm (24 PCS), Ø7x80 mm (16 PCS), Ø10x80 mm (8 PCS), Ø13x80 mm (8 PCS)

YATO
YT-068668 24

EN Heat-shrink tubing with glue set
PL Zestaw koszulek termokurczliwych z klejem
DE Schrumpfschlauch-Set mit Kleber
RU Набор термоусадочных трубок с клеем
CZ Sada smršťovacích bužírek s lepidlem
HU Ragasztós zsugorcső készlet

RO Set tub termocontractabil cu lipici
FR Jeu de gaines thermorétractables avec adhésif
IT Kit guaine termorestringenti con adesivo
ES Kit de tubos termorretráctiles adhesivos
CN 带胶热缩套管

270
PCS

MIX

max °C
125



Ø1.6x45 mm (70 PCS), Ø2.4x45 mm (80 PCS), Ø3.2x45 mm (80 PCS), Ø4.8x90 mm (20 PCS), Ø6.3x90 mm (12 PCS), Ø9.5x90 mm (8 PCS)

YATO
YT-068671 60

EN Heat shrink solder sleeve
PL Koszulka termokurczliwa z cyną
DE Wärmeschumpfende Verbinder mit Zinn
RU Термоусадочная гильза с оловом
CZ Smršťovací trubička s cínem
HU Hőre zsugorodó hüvely ónnal
RO Manson pt. lipit cu aer cald
FR Gaine thermorétractable avec étain
IT Guaine termorestringenti con stagno
ES Tubo termorretráctil con estaño
CN 免压热缩中接焊锡端子

30
PCS

0.25
x0.34
mm²

105
°C



YATO
YT-81440 Cross-sectional area / Przekrój przewodu
0.25-0.34 mm² / 24~22 AWG 25/1500

EN Heat-shrink tubing set
PL Zestaw koszulek termokurczliwych
DE Schrumpfschlauch-Set
RU Набор термоусадочных трубок
HU Zsugorcső készlet

RO Set tuburi termocontractabile
FR Jeu de gaines thermorétractables
IT Kit guaine termorestringenti
ES Kit de tubos termorretráctiles
CN 热收缩管

171
PCS

MIX

max °C
125



Ø2x30 mm (100 PCS), Ø4x60 mm (10 PCS), Ø4.5x60 mm (10 PCS), Ø5x60 mm (8 PCS), Ø6x60 mm (6 PCS), Ø8x90 mm (11 PCS), Ø9x90 mm (11 PCS), Ø12x90 mm (7 PCS), Ø18x90 mm (7 PCS), Ø10x1000 mm (1 PCS)

YATO
YT-06867 24

EN Heat-shrink tubing with glue set
PL Zestaw koszulek termokurczliwych z klejem
DE Schrumpfschlauch-Set mit Kleber
RU Набор термоусадочных трубок с клеем
CZ Sada smršťovacích bužírek s lepidlem
HU Ragasztós zsugorcső készlet

RO Set tub termocontractabil cu lipici
FR Jeu de gaines thermorétractables avec adhésif
IT Kit guaine termorestringenti con adesivo
ES Kit de tubos termorretráctiles adhesivos
CN 带胶热缩套管

530
PCS

MIX

max °C
125



Ø1.5x45 mm (80 PCS), Ø2x45 mm (160 PCS), Ø3x45 mm (60 PCS), Ø4x45 mm (100 PCS), Ø5x45 mm (30 PCS), 6x45 mm (20 PCS), Ø8x45 mm (20 PCS), Ø10x45 mm (60 PCS)

YATO
YT-068672 60

EN Heat shrink solder sleeve
PL Koszulka termokurczliwa z cyną
DE Wärmeschumpfende Verbinder mit Zinn
RU Термоусадочная гильза с оловом
CZ Smršťovací trubička s cínem
HU Hőre zsugorodó hüvely ónnal
RO Manson pt. lipit cu aer cald
FR Gaine thermorétractable avec étain
IT Guaine termorestringenti con stagno
ES Tubo termorretráctil con estaño
CN 免压热缩中接焊锡端子

100
PCS

0.25
x0.34
mm²

105
°C

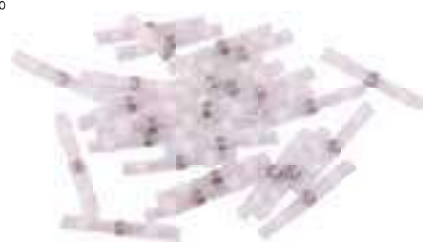



YATO
YT-81451 Cross-sectional area / Przekrój przewodu
0.25-0.34 mm² / 24~22 AWG 558

EN Heat shrink solder sleeve
 PL Koszulka termokurczliwa z cyną
 DE Wärmeschrumpfende Verbinder mit Zinn
 RU Термоусадочная гильза с оловом
 CZ Smršťovací trubička s cínem
 HU Hőre zsugorodó hüvely ónnal
 RO Manson pt. lipit cu aer cald
 FR Gaine thermorétractable avec étain
 IT Guaine termorestringenti con stagno
 ES Tubo termorretráctil con estaño
 CN 免压热缩中接焊锡端子

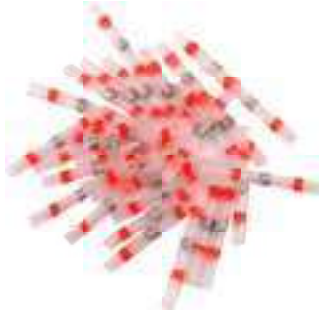
30 PCS
0.5 x**1.5** mm²
105 °C





YATO  Cross-sectional area / Przekrój przewodu 
YT-81441 0.5-1.5 mm² / 18-16 AWG 15/900

EN Heat shrink solder sleeve
 PL Koszulka termokurczliwa z cyną
 DE Wärmeschrumpfende Verbinder mit Zinn
 RU Термоусадочная гильза с оловом
 CZ Smršťovací trubička s cínem
 HU Hőre zsugorodó hüvely ónnal
 RO Manson pt. lipit cu aer cald
 FR Gaine thermorétractable avec étain
 IT Guaine termorestringenti con stagno
 ES Tubo termorretráctil con estaño
 CN 免压热缩中接焊锡端子

100 PCS
0.5 x**1.5** mm²
105 °C





YATO  Cross-sectional area / Przekrój przewodu 
YT-81452 0.5-1.5 mm² / 20-16 AWG 378

EN Heat shrink solder sleeve
 PL Koszulka termokurczliwa z cyną
 DE Wärmeschrumpfende Verbinder mit Zinn
 RU Термоусадочная гильза с оловом
 CZ Smršťovací trubička s cínem
 HU Hőre zsugorodó hüvely ónnal
 RO Manson pt. lipit cu aer cald
 FR Gaine thermorétractable avec étain
 IT Guaine termorestringenti con stagno
 ES Tubo termorretráctil con estaño
 CN 免压热缩中接焊锡端子

30 PCS
1.5 x**2.5** mm²
105 °C





YATO  Cross-sectional area / Przekrój przewodu 
YT-81442 1.5-2.5 mm² / 16-14 AWG 5/300

EN Heat shrink solder sleeve
 PL Koszulka termokurczliwa z cyną
 DE Wärmeschrumpfende Verbinder mit Zinn
 RU Термоусадочная гильза с оловом
 CZ Smršťovací trubička s cínem
 HU Hőre zsugorodó hüvely ónnal
 RO Manson pt. lipit cu aer cald
 FR Gaine thermorétractable avec étain
 IT Guaine termorestringenti con stagno
 ES Tubo termorretráctil con estaño
 CN 免压热缩中接焊锡端子

100 PCS
1.5 x**2.5** mm²
105 °C





YATO  Cross-sectional area / Przekrój przewodu 
YT-81453 1.5-2.5 mm² / 16-14 AWG 130

EN Heat shrink solder sleeve
 PL Koszulka termokurczliwa z cyną
 DE Wärmeschrumpfende Verbinder mit Zinn
 RU Термоусадочная гильза с оловом
 CZ Smršťovací trubička s cínem
 HU Hőre zsugorodó hüvely ónnal
 RO Manson pt. lipit cu aer cald
 FR Gaine thermorétractable avec étain
 IT Guaine termorestringenti con stagno
 ES Tubo termorretráctil con estaño
 CN 免压热缩中接焊锡端子

20 PCS
4.0 x**6.0** mm²
105 °C





YATO  Cross-sectional area / Przekrój przewodu 
YT-81443 4-6 mm² / 12-10 AWG 5/300

EN Heat shrink solder sleeve
 PL Koszulka termokurczliwa z cyną
 DE Wärmeschrumpfende Verbinder mit Zinn
 RU Термоусадочная гильза с оловом
 CZ Smršťovací trubička s cínem
 HU Hőre zsugorodó hüvely ónnal
 RO Manson pt. lipit cu aer cald
 FR Gaine thermorétractable avec étain
 IT Guaine termorestringenti con stagno
 ES Tubo termorretráctil con estaño
 CN 免压热缩中接焊锡端子

100 PCS
4.0 x**6.0** mm²
105 °C



YATO  Cross-sectional area / Przekrój przewodu 
YT-81454 4-6 mm² / 12-10 AWG 100

EN Heat shrink solder sleeve set
 PL Zestaw koszulek termokurczliwych z cyną
 DE Satz wärmeschrumpfender Verbinder mit Zinn
 RU Комплект термоусадочных гильз с оловом
 CZ Sada smršťovacích trubiček s cínem
 HU Hőre zsugorodó hüvelykészlet ónnal



RO Set mansoane lipit cu aer cald
 FR Jeu de gaines thermorétractables avec étain
 IT Set di guaine termorestringenti con stagno
 ES Conjunto de tubos termorretráctiles con estaño
 CN 免压热缩中接焊锡端子

100 PCS

0.25 x**6.0** mm²

105 °C



YATO  Cross-sectional area / Przekrój przewodu 
YT-81450 0.25-6 mm² / 26-10 AWG 150



EN Heat shrink solder sleeve set
 PL Zestaw koszulek termokurczliwych z cyną
 DE Satz wärmeschrumpfender Verbinder mit Zinn
 RU Комплект термоусадочных гильз с оловом
 CZ Sada smršťovacích trubiček s cínem
 HU Hőre zsugorodó hüvelykészlet ónnal
 RO Set mansoane lipit cu aer cald
 FR Jeu de gaines thermorétractables avec étain
 IT Set di guaine termorestringenti con stagno
 ES Kit de capas termorretráctiles con estaño
 CN 免压热缩中接焊锡管

220 PCS

0.25 x**6.0** mm²

105 °C



YATO  Cross-sectional area / Przekrój przewodu 
YT-81460 0.25-6 mm² / 24-10 AWG 60

- EN Heat shrink butt connectors set
PL Zestaw zaciskanych koszulek termokurczliwych
DE Satz gewellte Schrumpfhüllen
RU Набор обжимных термоусадочных трубок
CZ Sada upínacích teplem smršťovatelných bužirek
HU Szigetelt toldóhüvely készlet
RO Set de conectori termocontractabili
FR Jeu de manchons thermorétractables seris
IT Set di giunti termorestringenti con stagno
ES Juego de tubos termorretráctiles
CN 防水热缩端子

200
PCS

0.5
x6.0
mm²



□ 0.5-1.5 mm² (90 PCS), 1.5-2.5 mm² (90 PCS), 4.0-6.0 mm² (20 PCS)

YATO Cross-sectional area / Przekrój przewodu
YT-81461 0.5-6 mm² / 20~10 AWG 60

- EN Back probe kit
PL Zestaw przewodów i końcówek pomiarowych
DE Messleitungen und -endstücke
RU Набор кабелей и измерительных наконечников
CZ Sada měřících vodičů a koncovek
HU Vezeték és mérőfej készlet
- RO Trusa de sondă spată
FR Kit de cordons et de fiches de test
IT Set di cavi e terminali di misura
ES Juego de cables y puntas de medición
CN 万用表

20
PCS

0-30V
A.C.

0-30V
D.C.



YATO
YT-73079 24

- EN Car fuse assortment
PL Zestaw bezpieczników
DE KFZ-Sicherungs-Set
RU Набор предохранителей
CZ Sada pojistek
HU Biztosítékészlet
- RO Set sigurante
FR Ensemble de fusible
IT Kit di fusibili lamellari
ES Conjunto de fusibles
CN 保险插片

92
PCS

STANDARD

FUSE
PULLER
SZÁGACZ
BEZPECZNÍKŰ



5 A, 10 A, 15 A, 20 A, 25 A, 30 A (x15 PCS); tester 6-24 V

YATO
YT-83142 24

- EN Car fuse assortment
PL Zestaw bezpieczników
DE KFZ-Sicherungs-Set
RU Набор предохранителей
CZ Sada pojistek
HU Biztosítékészlet
- RO Set sigurante
FR Ensemble de fusible
IT Kit di fusibili lamellari
ES Conjunto de fusibles
CN 保险插片

100
PCS

MINI



7.5 A (10 PCS), 10 A (20 PCS), 15 A (20 PCS), 20 A (20 PCS), 25 A (20 PCS), 30 A (10 PCS)

YATO
YT-83145 12/60

- EN Superseal connectors wiring assortment
PL Zestaw złączy elektrycznych hermetycznych
DE Hermetischer Elektrostecker Satz
RU Набор герметичных электрических разъемов
CZ Sada hermetických elektrických svorek
HU Hermetikus elektromos csatlakozókészlet

- RO Muțe auto
FR Jeu de connecteurs électriques hermétiques
IT Kit di connettori elettrici a tenuta stagna
ES Set de herméticos conectores eléctricos
CN 低压电源线束快速接头

424
PCS

HERMETIC
HERMETYZNE

1-6
PIN

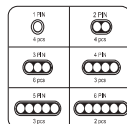

YATO
YT-06869 6/12

- EN Car fuse assortment
PL Zestaw bezpieczników
DE KFZ-Sicherungs-Set
RU Набор предохранителей
CZ Sada pojistek
HU Biztosítékészlet
- RO Set sigurante
FR Ensemble de fusible
IT Kit di fusibili lamellari
ES Conjunto de fusibles
CN 保险插片

24
PCS

MAXI



20 A, 30 A, 40 A, 50 A, 60 A, 70 A, 80 A, 100 A (x3 PCS)

YATO
YT-83140 24

- EN Car fuse assortment
PL Zestaw bezpieczników
DE KFZ-Sicherungs-Set
RU Набор предохранителей
CZ Sada pojistek
HU Biztosítékészlet
- RO Set sigurante
FR Ensemble de fusible
IT Kit di fusibili lamellari
ES Conjunto de fusibles
CN 保险插片

97
PCS

STANDARD

FUSE
PULLER
SZÁGACZ
BEZPECZNÍKŰ



3 A, 5 A, 7.5 A, 10 A, 15 A, 20 A, 25 A, 30 A (x12 PCS)

YATO
YT-83141 24

- EN Car fuse assortment
PL Zestaw bezpieczników
DE KFZ-Sicherungs-Set
RU Набор предохранителей
CZ Sada pojistek
HU Biztosítékészlet
- RO Set sigurante
FR Ensemble de fusible
IT Kit di fusibili lamellari
ES Conjunto de fusibles
CN 120汽车用保险片

120
PCS

MINI



5 A, 10 A, 15 A, 20 A, 25 A, 30 A (x20 PCS)

YATO
YT-83146 12

EN Car fuse assortment
 PL Zestaw bezpieczników
 DE KFZ-Sicherungs-Set
 RU Набор предохранителей
 CZ Sada pojistek
 HU Biztosítékészlet

RO Set sigurante
 FR Ensemble de fusible
 IT Kit di fusibili lamellari
 ES Conjunto de fusibles
 CN 保险插片

88
PCS

STANDARD

MAXI

MINI



Mini: 3 A, 5 A, 7.5 A, 10 A, 15 A, 20 A, 25 A, 30 A (x5 PCS); standard: 3 A, 5 A, 7.5 A, 10 A, 15 A, 20 A, 25 A, 30 A (x5 PCS); max: 20 A, 30 A, 40 A, 50 A, 60 A, 70 A, 80 A, 100 A

YATO

YT-83147 24

EN Car fuse assortment
 PL Zestaw bezpieczników
 DE KFZ-Sicherungs-Set
 RU Набор предохранителей
 CZ Sada pojistek
 HU Biztosítékészlet

RO Set sigurante
 FR Ensemble de fusible
 IT Kit di fusibili lamellari
 ES Conjunto de fusibles
 CN 保险插片

301
PCS

STANDARD

MINI

FUSE
PULLER
SZÁGACZ
BEEPCZINKŰ



Mini: 2 A (6 PCS), 3 A (6 PCS), 5 A (12 PCS), 7.5 A (10 PCS), 10 A (28 PCS), 15 A (24 PCS), 20 A (22 PCS), 25 A (10 PCS), 30 A (14 PCS), 35 A (6 PCS), 40 A (12 PCS); standard: 2 A (6 PCS), 3 A (6 PCS), 5 A (12 PCS), 7.5 A (10 PCS), 10 A (28 PCS), 15 A (24 PCS), 20 A (22 PCS), 25 A (10 PCS), 30 A (14 PCS), 35 A (6 PCS), 40 A (12 PCS); clip

YATO

YT-83148 20

EN Car fuse assortment
 PL Zestaw bezpieczników
 DE KFZ-Sicherungs-Set
 RU Набор предохранителей
 CZ Sada pojistek
 HU Biztosítékészlet

RO Set sigurante
 FR Ensemble de fusible
 IT Kit di fusibili lamellari
 ES Conjunto de fusibles
 CN 120汽车保险片

120
PCS

STANDARD



5 A, 10 A, 15 A, 20 A, 25 A, 30 A (x20 PCS)

YATO

YT-83144 12

EN Car fuse assortment
 PL Zestaw bezpieczników
 DE KFZ-Sicherungs-Set
 RU Набор предохранителей
 CZ Sada pojistek
 HU Biztosítékészlet

RO Set sigurante
 FR Ensemble de fusible
 IT Kit di fusibili lamellari
 ES Conjunto de fusibles
 CN 保险插片

121
PCS

MINI

FUSE
PULLER
SZÁGACZ
BEEPCZINKŰ



5 A, 10 A, 15 A, 20 A, 25 A, 30 A (x20 PCS)

YATO

YT-83143 24

EN Glass fuse assortment
 PL Zestaw bezpieczników szklanych
 DE Glas-Sicherungssatz
 RU Набор стеклянных предохранителей
 CZ Sada skleněných pojistek
 HU Üveg biztosíték készlet

RO Set sigurante sticla
 FR Ensemble de fusibles en verre
 IT Set di fusibili in vetro
 ES Set de fusibles de vidrio
 CN 玻璃管保险丝

120
PCS

6x30
mm

GLASS
SZKLO



5 A, 10 A, 15 A, 20 A, 25 A, 30 A (x20 PCS)

YATO

YT-83130 5/20

EN Trim clips assortment
 PL Komplet spinek samochodowych
 DE Befestigungs-Clip-Satz
 RU Набор автомобильного крепежа
 CZ Sada příchytek čalounění
 HU Kötőelemek szegecsek
 HU Kötőelemek szegecsek
 FR Ensembles de clips en plastique auto
 IT Set di clip per auto
 ES Clip de plástico surtido
 CN 塑料卡扣

360
PCS

18
TYPES
TYPY



Toyota, Lexus

YATO

YT-06650 20

EN Trim clips assortment
 PL Komplet spinek samochodowych
 DE Befestigungs-Clip-Satz
 RU Набор автомобильного крепежа
 CZ Sada příchytek čalounění
 HU Kötőelemek szegecsek
 RO Clip de plastic asortat
 FR Ensembles de clips en plastique auto
 IT Set di clip per auto
 ES Clip de plástico surtido
 CN 塑料卡扣

300
PCS

6
TYPES
TYPY



Renault

YATO

YT-06651 20

EN Trim clips assortment
 PL Komplet spinek samochodowych
 DE Befestigungs-Clip-Satz
 RU Набор автомобильного крепежа
 CZ Sada příchytek čalounění
 HU Kötőelemek szegecsek
 RO Clip de plastic asortat
 FR Ensembles de clips en plastique auto
 IT Set di clip per auto
 ES Clip de plástico surtido
 CN 塑料卡扣

300
PCS

6
TYPES
TYPY



Opel

YATO

YT-06652 20

EN Trim clips assortment
PL Komplet spinek samochodowych
DE Befestigungs-Clip-Satz
RU Набор автомобильного крепежа
CZ Sada přichytek čalounění
HU Kötőelemek szegecsek
RO Clip de plastic asortat
FR Ensembles de clips en plastique auto
IT Set di clip per auto
ES Clip de plástico surtido
CN 塑料卡扣

345
PCS

12
TYPES
TYPY

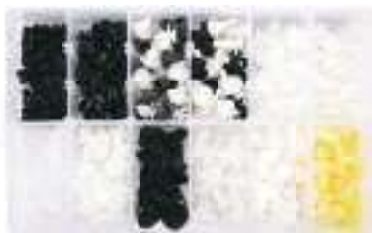
 Peugeot

YATO  
YT-06653 20

EN Trim clips assortment
PL Komplet spinek samochodowych
DE Befestigungs-Clip-Satz
RU Набор автомобильного крепежа
CZ Sada přichytek čalounění
HU Kötőelemek szegecsek
RO Clip de plastic asortat
FR Ensembles de clips en plastique auto
IT Set di clip per auto
ES Clip de plástico surtido
CN 塑料卡扣

350
PCS

12
TYPES
TYPY



 Volvo

YATO  
YT-06655 20

EN Trim clips assortment
PL Komplet spinek samochodowych
DE Befestigungs-Clip-Satz
RU Набор автомобильного крепежа
CZ Sada přichytek čalounění
HU Kötőelemek szegecsek
RO Clip de plastic asortat
FR Ensembles de clips en plastique auto
IT Set di clip per auto
ES Clip de plástico surtido
CN 塑料卡扣

408
PCS

18
TYPES
TYPY



 Nissan

YATO  
YT-06657 20

EN Trim clips assortment
PL Komplet spinek samochodowych
DE Befestigungs-Clip-Satz
RU Набор автомобильного крепежа
CZ Sada přichytek čalounění
HU Kötőelemek szegecsek
RO Clip de plastic asortat
FR Ensembles de clips en plastique auto
IT Set di clip per auto
ES Clip de plástico surtido
CN 塑料卡扣

370
PCS

12
TYPES
TYPY





 Mitsubishi

YATO  
YT-06659 20

EN Trim clips assortment
PL Komplet spinek samochodowych
DE Befestigungs-Clip-Satz
RU Набор автомобильного крепежа
CZ Sada přichytek čalounění
HU Kötőelemek szegecsek
RO Clip de plastic asortat
FR Ensembles de clips en plastique auto
IT Set di clip per auto
ES Clip de plástico surtido
CN 塑料卡扣

308
PCS

12
TYPES
TYPY





 Fiat

YATO  
YT-06654 20

EN Trim clips assortment
PL Komplet spinek samochodowych
DE Befestigungs-Clip-Satz
RU Набор автомобильного крепежа
CZ Sada přichytek čalounění
HU Kötőelemek szegecsek
RO Clip de plastic asortat
FR Ensembles de clips en plastique auto
IT Set di clip per auto
ES Clip de plástico surtido
CN 塑料卡扣

418
PCS

18
TYPES
TYPY





 Honda

YATO  
YT-06656 20

EN Trim clips assortment
PL Komplet spinek samochodowych
DE Befestigungs-Clip-Satz
RU Набор автомобильного крепежа
CZ Sada přichytek čalounění
HU Kötőelemek szegecsek
RO Clip de plastic asortat
FR Ensembles de clips en plastique auto
IT Set di clip per auto
ES Clip de plástico surtido
CN 塑料卡扣

475
PCS

18
TYPES
TYPY





 Mazda

YATO  
YT-06658 20

EN Trim clips assortment
PL Komplet spinek samochodowych
DE Befestigungs-Clip-Satz
RU Набор автомобильного крепежа
CZ Sada přichytek čalounění
HU Kötőelemek szegecsek
RO Clip de plastic asortat
FR Ensembles de clips en plastique auto
IT Set di clip per auto
ES Clip de plástico surtido
CN 塑料卡扣

415
PCS

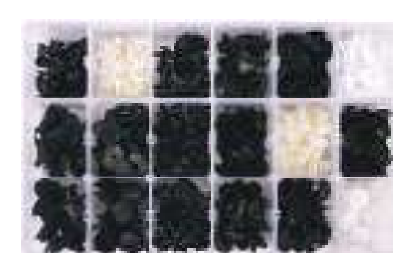
18
TYPES
TYPY

 Ford

YATO  
YT-06660 20

