







Drills Wiertła		Circular dies Narzynki	178
157-169		Step drills Wiertła stopniowe	179
Twist drill bits HSS & sets Wiertła do metalu HSS i zestawy	157	Taper drill sets Zestawy wiertel stożkowych	179
Double end metal twist drills Wiertła do metalu dwustronne	158	Countersinks & sets Pogłębiacze i zestawy	179
Twist drill bits HSS-E Co & sets Wiertła do metalu HSS-E Co i zestawy	158	Tap wrenches & die holders Pokręta do gwintowników i narzynek	180
Twist drill bits HSS-TiN & sets Wiertła do metalu HSS-TiN i zestawy	159	Plug and forstner cutters & sets Flekowniki-sękowniki do drewna i zestawy	180
Universal drills & sets Wiertła uniwersalne i zestawy	162	Router bits, rotary rasps & sets Frezy do drewna, metalu i zestawy	181-185
SDS masonry drill bits X-TIP Wiertła do betonu SDS, z grotem krzyżowym	163	Diamond tools Narzędzia diamentowe	186-187
SDS masonry drill bits Wiertła do betonu SDS	164	Diamond blades for cutting construction materials Tarcze diamentowe do cięcia materiałów budowlanych	186
Masonry drill bits with cylindrical shank & sets Wiertła do betonu z uchwytem cylindrycznym i zestawy	165	Diamond grinding cup wheels Diamentowe talerze szlifierskie do betonu i kamienia	187
Flat wood drill bits & sets Wiertła łopatkowe do drewna i zestawy	165	Diamond core drill bits Diamentowe wiertła koronowe	187
Spur wood drill bits Wiertła do drewna spiralne	166	Tungsten carbide tipped tools Narzędzia z ostrzem z węgliku wolframu	188-189
Auger wood drill bits & sets Świdry do drewna i zestawy	166	Tungsten carbide saws for wood Tarcze z węglikiem do drewna	188
Confirmat screw drill bits Wiertła do konfirmatów	168	Tungsten carbide saws for steel & aluminium Tarcze z węglikiem do stali i aluminium	189
Drills for glass, ceramic tiles & sets Wiertła do szkła, ceramiki, gresu i zestawy	168	PVC cutting discs Tarcze do cięcia PCV	189
Drilling accessories Akcesoria do wiercenia	168	Cutting & grinding discs Tarcze do cięcia i szlifowania	190-192
Adjustable hand reamers Rozwiertaki nastawne	169	Stainless steel cutting discs Tarcze do cięcia stali nierdzewnej	190
Tools for dowel joints Narzędzia do połączeń kołkowych	169-170	Metal cutting discs Tarcze do cięcia metalu	190
SDS Chisels Przecinaki i dłuta SDS	171-173	Metal grinding discs Tarcze do szlifowania metalu	190
Hollow drill sets Wiertła koronowe do betonu	174	Stone cutting discs Tarcze do cięcia kamienia	191
Hole saws Otwornice	174-176	Stone grinding discs Tarcze do szlifowania kamienia	191
Universal hole saws Otwornice uniwersalne	174	Plate discs with hook fastener Tarcze z rzepem	191
Bi-metal hole saws Otwornice bimetalowe	174	Cutting & grinding rasp discs Tarcze tarnikowe do cięcia i szlifowania	191
Arbors for hole saws Uchwyty do otwornic	175		
Hole saw kits Zestawy otwornic	176		
Taps & dies Narzędzia do gwintowania	177-180		
Hand taps & sets Gwintowniki i zestawy	177		



Shears			193-198	Squeegees		
Nożyce				Rakle.....	217	
.....				Scissors		
Tin snips				Nożyczki.....	217	
Nożyce do blachy.....	193			Marking out tools		
Steel strap cutters				Narzędzia traserskie.....	217	
Nożyce do cięcia taśm stalowych.....	196			Punch sets		
Bolt cutters				Przebijaki do skóry.....	219	
Nożyce do prętów.....	196			Scrapers		
Hydraulic cutters & accessories				Skrobaki i cykliny.....	220	
Nożyce z siłownikiem hydraulicznym i akcesoria.....	197			Planes		
Multifunctional scissors				Strugi.....	221	
Nożyce wielofunkcyjne.....	198			Steel files & sets		
Saws & blades			193-198	Pilniki do metalu i zestawy	222	
Piły i brzeszczoty				Needle file sets		
.....				Zestawy pilników iglaków.....	223	
Hand saws				Diamond needle files & sets		
Piły do drewna.....	198			Pilniki iglaki diamentowe i zestawy.....	223	
Back saws for PVC				Diamond whetstones		
Piły do PCV.....	198			Osełki diamentowe.....	225	
Drywall saws				Rasps & sets		
Piły do płyt gipsowo-kartonowych.....	198			Tarniki do drewna i zestawy.....	225	
Bow saws				Rasps for plaster		
Piły kabląkowe.....	199			Tarniki do gipsu.....	225	
Blades				Abrasive products		
Brzeszczoty.....	200			Artykuły ściernie		
Hacksaw frames					226-232
Piły do metalu.....	200			Sand papers		
Blades				Papiery ściernie.....	226	
Brzeszczoty.....	200			Waterproof sand papers		
Jig saw blades				Papiery ściernie wodoodporne.....	226	
Brzeszczoty do wyrzynarek.....	202			Abrasive clothes		
Accessories for multi-purpose oscillating tools				Płótna ściernie.....	227	
Akcesoria do wielofunkcyjnych narzędzi oscylacyjnych.....	204			Abrasive meshes		
Brushes, knives & files			209-225	Siatki ściernie	227	
Szczotki, noże i pilniki				No end abrasive bands		
.....				Taśmy ściernie bezkońcowe.....	227	
Wire brushes & sets				Abrasive sponges		
Szczotki druciane i zestawy.....	209			Kostki ściernie.....	228	
Cup brushes				Abrasive sheets and discs		
Szczotki tarczowe.....	210			Arkusze i krążki ściernie.....	229	
Electric screwdriver accessories				Back pads for drywall sander		
Akcesoria do wkrętarek.....	213			Głowice do szlifierki do gipsu.....	232	
Knives & blades				Polishing products		
Noże i ostrza.....	214			Artykuły polerskie		
.....					232-234

EN Twist drill HSS
PL Wiertło do metalu HSS
DE Metallspiralbohrer HSS
RU Сверло по металлу HSS
CZ Vrták na kov HSS
HU Fúrószár fémhez HSS

RO Burghiu pt. metal HSS
FR Foret métal HSS
IT Punta per metallo HSS
ES Broca para metal HSS
CN 轧制麻花钻

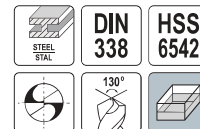

• Application: industry
• For precise drilling in steels, cast steels, non-ferrous metals, plastics

• Przeznaczenie: przemysł
• Do precyzyjnych wierceń w stalach, żeliwach, metalach nieżelaznych, tworzywach sztucznych

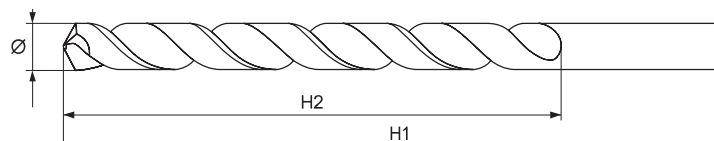

YATO	Ø [mm]	H1 [mm]	H2 [mm]	ω [min ⁻¹]	pcs / szt.	Box
YT-4430	1.0	34	23	3800	10	80/320
YT-4431	1.5	43	20	3800	10	80/320
YT-4432	2.0	49	24	4000	10	80/320
YT-4433	2.5	57	30	3200	10	80/320
YT-4434	2.8	61	33	2800	10	80/320
YT-4435	3.0	61	33	2600	10	80/320
YT-4436	3.2	65	36	2500	10	80/320
YT-4437	3.5	70	39	2300	10	80/320
YT-4438	4.0	75	43	2000	10	80/320
YT-4439	4.2	75	43	1900	10	20/80

YATO	Ø [mm]	H1 [mm]	H2 [mm]	ω [min ⁻¹]	pcs / szt.	Box
YT-4440	4.5	80	47	1800	10	20/80
YT-4441	4.8	86	52	1600	10	20/80
YT-4442	5.0	86	52	1600	10	20/80
YT-4443	5.2	86	52	1500	10	20/80
YT-4444	5.5	93	57	1500	10	20/80
YT-4445	6.0	93	57	1300	10	20/80
YT-4446	6.5	101	63	1200	10	10/40
YT-4447	7.0	109	69	1100	10	10/40
YT-4448	7.5	109	69	1100	10	10/40
YT-4449	8.0	117	75	1000	10	10/40

YATO	Ø [mm]	H1 [mm]	H2 [mm]	ω [min ⁻¹]	pcs / szt.	Box
YT-4450	8.5	117	75	900	5	10/40
YT-4451	9.0	125	81	900	5	10/40
YT-4452	9.5	125	81	800	5	10/40
YT-4453	10.0	133	87	800	5	10/40
YT-4454	10.5	133	87	800	3	10/40
YT-4455	11.0	142	94	700	3	10/40
YT-4456	12.0	151	101	700	3	10/40
YT-4457	12.5	151	101	600	3	10/40
YT-4458	13.0	151	101	600	3	10/40

EN Twist drill set
PL Komplet wiertel do metalu
DE Metallspiralbohrersatz

RU Набор сверл по металлу
CZ Souprava vrtáků na kov
HU Fúrószárkészlet fémhez

RO Set de burghie pt. metal
FR Set des forets métal HSS
IT Set punte per metallo

ES Broca para metal
CN 轧制麻花钻组套



6
PCS

Ø
2.0-8.0
mm

YATO	Ø [mm]	Box
YT-4460	2, 3, 4, 5, 6, 8	15/60



10
PCS

Ø
1.0-10
mm

YATO	Ø [mm]	Box
YT-4461	1, 2, 3, 4, 5, 6, 7, 8, 9, 10	20/40

19
PCS

Ø
1.0-10
mm

YATO	Ø [mm]	Box
YT-4462	1, 1.5, 2, 2.5, 3, 3.5, 4, 4.5, 5, 5.5, 6, 6.5, 7, 7.5, 8, 8.5, 9, 9.5, 10	15/30

EN Twist drill HSS
PL Wiertło do metalu HSS
DE Metallspiralbohrer HSS
RU Сверло по металлу HSS
CZ Vrták na kov HSS
HU Fúrószár fémhez HSS

RO Burghiu pt. metal HSS
FR Foret métal HSS
IT Punta per metallo HSS
ES Broca para metal HSS
CN 磨制麻花钻

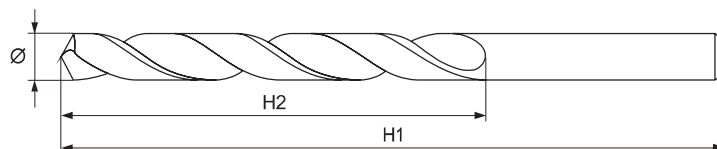

YATO	Ø [mm]	H1 [mm]	H2 [mm]	pcs / szt.	Box
YT-44200	0.5	22	6	5	100/400
YT-44201	0.8	30	10	5	100/400
YT-44202	1.0	34	11	5	100/400
YT-44203	1.5	40	18	5	100/400
YT-44204	2.0	48	22	5	100/400
YT-44205	2.2	53	28	5	50/400
YT-44206	2.4	56	30	5	100/400
YT-44207	2.5	57	30	5	100/400
YT-44208	2.8	62	30	5	100/400
YT-44209	3.0	61	34	1	100/400
YT-44210	3.1	65	35	1	100/400
YT-44211	3.2	65	35	1	100/400
YT-44212	3.5	70	40	1	100/400
YT-44213	3.8	77	48	1	100/400

YATO	Ø [mm]	H1 [mm]	H2 [mm]	pcs / szt.	Box
YT-44214	4.0	74	44	1	100/400
YT-44215	4.1	75	44	1	100/400
YT-44216	4.2	75	45	1	100/400
YT-44217	4.5	79	45	1	100/400
YT-44218	4.8	85	51	1	100/400
YT-44219	5.0	86	52	1	100/400
YT-44220	5.2	86	52	1	100/400
YT-44221	5.5	92	56	1	100/400
YT-44222	6.0	93	56	1	100/400
YT-44223	6.5	100	63	1	100/400
YT-44224	7.0	103	64	1	50/300
YT-44225	7.5	108	70	1	50/300
YT-44226	8.0	115	75	1	50/300
YT-44227	8.5	115	73	1	50/300

YATO	Ø [mm]	H1 [mm]	H2 [mm]	pcs / szt.	Box
YT-44228	9.0	125	81	1	50/300
YT-44229	9.5	125	82	1	50/300
YT-44230	10.0	133	87	1	50/200
YT-44231	10.2	130	85	1	50/200
YT-44232	10.5	132	82	1	50/200
YT-44233	11.0	142	95	1	50/200
YT-44234	11.5	142	95	1	50/150
YT-44235	12.0	150	100	1	50/150
YT-44236	12.5	150	100	1	50/150
YT-44237	13.0	150	100	1	50/150
YT-44238	14.0	160	110	1	25/100
YT-44239	16.0	176	122	1	25/100
YT-44240	20.0	205	140	1	25/50

EN Double end metal twist drill
 PL Wiertło do metalu dwustronne
 DE Metallbohrer, doppelseitig
 RU Двухстороннее сверло по металлу
 CZ Vrták do kovu dvoustranný
 HU Kétoldalas fém fúrószer
 RO Set burghie metal, capăt dublu
 FR Foret pour métal à double extrémité
 IT Punta doppia per metallo
 ES Broca para metal doble
 CN 双头全磨制麻花钻

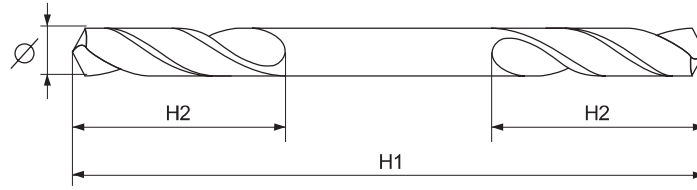

YATO	Ø [mm]	H1 [mm]	H2 [mm]	Box
YT-40010	3.0	46	9.5	100/500
YT-40011	3.2	49	9.5	100/500
YT-40012	3.5	52	13	100/500
YT-40013	4.0	55	13	100/500
YT-40014	4.2	55	13	100/500

YATO	Ø [mm]	H1 [mm]	H2 [mm]	Box
YT-40015	4.5	58	16	100/500
YT-40016	5.0	62	16	100/500
YT-40017	5.2	62	16	100/500
YT-40018	5.5	66	16	50/500
YT-40019	6.0	66	16	50/500

EN Double end metal twist drill set
 PL Zestaw dwustronnych wiertel do metalu
 DE Satz von doppelseitigen Bohrem für Metall
 RU Набор двухсторонних сверл по металлу
 CZ Sada oboustranných vrtáku do kovu
 HU Kétoldalas fémfúró szer készlet
 RO Set burghie metal cu cap dublu
 FR Ensemble de forets pour métaux à deux côtés
 IT Set di punte a doppia estremità per metallo
 ES Juego de brocas de doble punta para metal
 CN 双头钻组套



YATO	Ø [mm]	Box
YT-40025	3.0, 3.2, 3.5, 4.0, 4.2, 4.5, 5.0, 5.2, 5.5, 6.0	10/240

EN Twist drill HSS-Cobalt
 PL Wiertło do metalu HSS-Cobalt
 DE Metaspindelbohrer HSS-Cobalt
 RU Сверло по металлу HSS-Cobalt
 CZ Vrták na kov HSS-Cobalt
 HU Fúrószer fémhez HSS-Cobalt

RO Burghiu pt. metal HSS-Cobalt
 FR Foret métal HSS-Cobalt
 IT Punta per metallo HSS-Cobalt
 ES Broca para metal HSS-Cobalt
 CN 全磨制含钴麻花钻

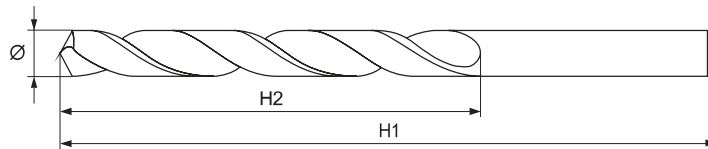

- Application: industry
- For precise drilling in hard steels, non-ferrous metals, plastics, stainless steel and acid resistant steel
- Resistant to high temperatures
- Przeznaczenie: przemysł
- Do precyzyjnych wierceń w trudnych materiałach, np. stalach szlachetnych, metalach kolorowych, tworzywach, stalach nierdzewnych i kwasoodpornych
- Odporne na działanie wysokiej temperatury

YATO	Ø [mm]	H1 [mm]	H2 [mm]	pcs / szt.	Box
YT-4020	2.0	49	24	2	125/500
YT-4025	2.5	57	30	2	125/500
YT-4030	3.0	61	33	2	125/500
YT-4032	3.2	65	36	1	100/400
YT-4035	3.5	70	39	1	100/400
YT-4040	4.0	75	43	1	100/400
YT-4042	4.2	75	43	1	100/400
YT-4045	4.5	80	47	1	100/400
YT-4048	4.8	86	52	1	100/400
YT-4050	5.0	86	52	1	100/400
YT-4052	5.2	86	52	1	100/400
YT-4055	5.5	93	57	1	100/400

YATO	Ø [mm]	H1 [mm]	H2 [mm]	pcs / szt.	Box
YT-4060	6.0	93	57	1	100/400
YT-4065	6.5	101	63	1	75/300
YT-4070	7.0	109	69	1	75/300
YT-4075	7.5	109	69	1	75/300
YT-4080	8.0	117	75	1	75/300
YT-4085	8.5	117	75	1	75/300
YT-4090	9.0	125	81	1	75/300
YT-4100	10.0	133	87	1	75/300
YT-4110	11.0	142	94	1	75/300
YT-4120	12.0	151	101	1	75/300
YT-4140	14.0	160	108	1	25/100
YT-4160	16.0	178	120	1	25/100

EN Twist drill set
PL Komplet wiertel do metalu
DE Metallspiralbohrersatz
RU Набор сверл по металлу
CZ Souprava vrtáků na kov
HU Fúrószárkészlet fémhez
RO Set de burghie pt. metal
FR Set des forets métal HSS
IT Set punte per metallo
ES Broca para metal
CN 全磨制含钴麻花钻组套



6
PCS

∅
2.0-8.0
mm

10
PCS

∅
1.0-10
mm

YATO	∅ [mm]	
YT-41602	2, 3, 4, 5, 6, 8	15/60
YATO	∅ [mm]	
YT-41603	1, 2, 3, 4, 5, 6, 7, 8, 9, 10	20/40



19
PCS

∅
1.0-10
mm



25
PCS

∅
1.0-13
mm

YATO	∅ [mm]	
YT-41604	1, 1.5, 2, 2.5, 3, 3.5, 4, 4.5, 5, 5.5, 6, 6.5, 7, 7.5, 8, 8.5, 9, 9.5, 10	15/30
YATO	∅ [mm]	
YT-41605	1, 1.5, 2, 2.5, 3, 3.5, 4, 4.5, 5, 5.5, 6, 6.5, 7, 7.5, 8, 8.5, 9, 9.5, 10, 10.5, 11, 11.5, 12, 12.5, 13	10

EN Twist drill
PL Wierć do metalu
DE Metallspiralbohrer
RU Сверло по металлу
CZ Vrták na kov
HU Fúrószár fémhez
RO Burghiu pt. metal
FR Foret métal
IT Punte per metallo
ES Broca para metal
CN 全磨制麻花钻

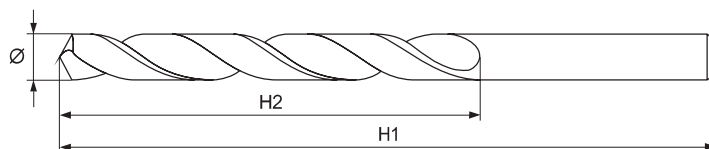

YATO	∅ [mm]	H1 [mm]	H2 [mm]	pcs / szt.	
YT-44630	1.0	34	12	2	50/500
YT-44631	1.5	40	18	2	50/500
YT-44632	2.0	49	24	2	50/500
YT-44633	2.5	57	30	2	50/500
YT-44634	2.8	61	33	2	50/500
YT-44635	3.0	61	33	2	50/500
YT-44637	3.2	65	36	1	50/500
YT-44639	3.5	70	39	1	50/500
YT-44640	4.0	75	43	1	50/500
YT-44642	4.2	75	43	1	50/500

YATO	∅ [mm]	H1 [mm]	H2 [mm]	pcs / szt.	
YT-44643	4.5	80	47	1	50/500
YT-44645	4.8	86	52	1	50/500
YT-44650	5.0	86	52	1	50/500
YT-44652	5.2	86	52	1	50/500
YT-44653	5.5	93	57	1	50/500
YT-44654	6.0	93	57	1	50/500
YT-44655	6.5	101	63	1	50/250
YT-44656	7.0	109	69	1	50/250
YT-44657	7.5	109	69	1	50/250
YT-44658	8.0	117	75	1	50/250

YATO	∅ [mm]	H1 [mm]	H2 [mm]	pcs / szt.	
YT-44659	8.5	117	75	1	50/250
YT-44660	9.0	125	81	1	50/250
YT-44661	9.5	125	81	1	50/250
YT-44662	10.0	133	87	1	50/200
YT-44663	10.5	133	87	1	50/200
YT-44664	11.0	142	94	1	50/200
YT-44666	12.0	151	101	1	50/100
YT-44667	12.5	151	101	1	50/100
YT-44668	13.0	151	101	1	50/100

EN Twist drill set
 PL Komplet wiertel do metalu
 DE Metaspiralbohrersatz
 RU Набор сверл по металлу
 CZ Souprava vrtáků na kov
 HU Fúrószárkészlet fémhez

RO Set de burghie pt. metal
 FR Set de forets métal
 IT Set punte per metallo
 ES Juego de brocas para metal
 CN 轧制麻花钻

190
PCS

DIN 338

HSS 4241

STEEL
STEEL

1.0-13
mm

TITANIUM
COATED
POWŁOKA
TYTANOWA

135°

EN Long metal drills
 PL Długie wiertła do metalu
 DE Lange Bohrer für Metall
 RU Длинные сверла по металлу
 CZ Dlouhé vrtáky do kovu
 HU Hosszú fémfúrószárak

RO Burghie lungi pt. metal
 FR Longs forets à métaux
 IT Punte lunghe per metallo
 ES Brocas largas para metal
 CN 加长麻花钻组套

5
PCS

DIN 1869

HSS 4341

STEEL
STEEL

FULLY
GROUND
WERTLO
SZLIFOWANE

118°



YATO	Ø [mm]	
YT-44677	1, 1.5, 2, 2.5, 3, 3.2, 3.5, 4, 4.2, 4.5, 5, 5.5, 6, 6.5, 7, 7.5, 8, 8.5, 9, 9.5, 10, 10.5, 11, 11.5, 12, 12.5, 13	5

YATO	Ø [mm]	
YT-39820	3, 4, 5, 6, 8	20/80

EN Twist drill
 PL Wiertło do metalu
 DE Metaspiralbohrer
 RU Сверно по металлу
 CZ Vrták na kov
 HU Fúrószár fémhez

RO Burghiu pt. metal
 FR Foret métal
 IT Punte per metallo
 ES Broca para metal
 CN 全磨制含钴麻花钻

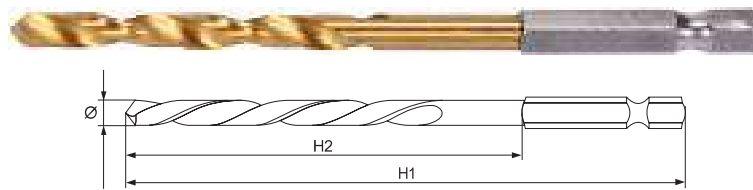

STEEL
STEEL

1/4"
6.3 mm

TITANIUM
COATED
POWŁOKA
TYTANOWA

DIN 338

HSS 4241

YATO	Ø [mm]	H1 [mm]	H2 [mm]	pcs / szt.	
YT-44750	1.5	63	18	1	150/600
YT-44751	2.0	72	24	1	150/600
YT-44752	2.5	80	30	1	150/600
YT-44754	3.0	81	33	1	150/600
YT-44755	3.2	85	36	1	150/600
YT-44756	3.5	90	39	1	150/600
YT-44757	4.0	95	43	1	150/600
YT-44758	4.2	95	43	1	100/400

YATO	Ø [mm]	H1 [mm]	H2 [mm]	pcs / szt.	
YT-44759	4.5	100	47	1	150/600
YT-44760	4.8	106	52	1	100/400
YT-44761	5.0	106	52	1	100/400
YT-44763	5.5	113	57	1	100/400
YT-44764	6.0	113	57	1	100/400
YT-44765	6.5	121	63	1	100/400
YT-44766	7.0	109	69	1	100/400
YT-44767	7.5	109	69	1	100/400

YATO	Ø [mm]	H1 [mm]	H2 [mm]	pcs / szt.	
YT-44768	8.0	117	75	1	100/400
YT-44769	8.5	117	75	1	100/400
YT-44770	9.0	125	81	1	50/200
YT-44772	10.0	133	87	1	50/200
YT-44773	11.0	142	94	1	50/200
YT-44774	12.0	151	101	1	50/200
YT-44776	13.0	151	101	1	50/200

EN Twist drill
 PL Wiertło do metalu
 DE Spiralbohrer
 RU Сверно по металлу
 CZ Vrták na kov
 HU Fúrószár fémhez

RO Burghiu pt. metal
 FR Foret hélicoïdal
 IT Punte per metallo
 ES Broca espiral
 CN 整体六角柄全磨钻



STEEL
STEEL

1/4"
6.3 mm

DIN 338

HSS 6542

135°

FULLY
GROUND
WERTLO
SZLIFOWANE

YATO	Ø [mm]	H1 [mm]	H2 [mm]	pcs / szt.	
YT-44860	1.5	57	26	1	100/500
YT-44861	2.0	57	26	1	100/500
YT-44863	3.0	61	31	1	100/500
YT-44864	3.2	65	34	1	100/500
YT-44865	3.5	70	38	1	100/500
YT-44866	4.0	75	43	1	100/500
YT-44867	4.2	75	43	1	50/300
YT-44868	4.5	80	47	1	50/200

YATO	Ø [mm]	H1 [mm]	H2 [mm]	pcs / szt.	
YT-44869	4.8	86	52	1	50/200
YT-44870	5.0	86	52	1	50/200
YT-44871	5.5	93	57	1	50/200
YT-44872	6.0	93	57	1	50/200
YT-44873	6.5	101	63	1	50/200
YT-44874	7.0	109	69	1	50/200
YT-44875	7.5	109	69	1	50/200
YT-44876	8.0	117	75	1	50/200

YATO	Ø [mm]	H1 [mm]	H2 [mm]	pcs / szt.	
YT-44877	8.5	117	75	1	50/200
YT-44878	9.0	125	81	1	50/200
YT-44879	9.5	125	81	1	50/200
YT-44880	10.0	133	87	1	50/200
YT-44881	10.5	133	87	1	50/100
YT-44882	11.0	142	94	1	50/100
YT-44883	12.0	151	101	1	50/100
YT-44884	13.0	151	101	1	50/100

EN Saw drill
 PL Wiertło frezujące do metalu
 DE Metall-Fräsböhrer
 RU Сверно фрезервальное по металлу
 CZ Vrták frézovací
 HU Maróúró fémhez

RO Burghiu freza
 FR Foret de fraisage
 IT Punta per fresatura metalli
 ES Broca de sierra
 CN 整体六角柄锯钻

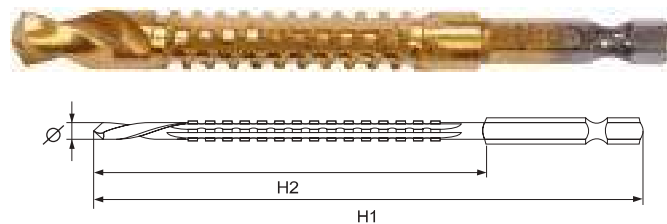

STEEL
STEEL

1/4"
6.3 mm

118°

TITANIUM
COATED
POWŁOKA
TYTANOWA

HRC 58-62

HSS 4241

YATO	Ø [mm]	H1 [mm]	H2 [mm]	pcs / szt.	
YT-44820	3.0	70	35	1	150/600
YT-44821	4.0	78	43	1	100/300
YT-44822	5.0	81	46	1	100/400
YT-44823	6.0	89	54	1	100/400

YATO	Ø [mm]	H1 [mm]	H2 [mm]	pcs / szt.	
YT-44824	6.5	89	54	1	100/400
YT-44826	8.0	99	64	1	100/400
YT-44827	9.0	102	67	1	50/200
YT-44828	10.0	105	70	1	50/200

YATO	Ø [mm]	H1 [mm]	H2 [mm]	pcs / szt.	
YT-44829	11.0	110	75	1	50/200
YT-44830	12.0	115	80	1	50/200
YT-44831	13.0	120	85	1	50/200

EN Twist drill set
PL Komplet wiertel do metalu
DE Metallspiralbohrersatz
RU Набор сверл по металлу
CZ Souprava vrtáků na kov
HU Fúrószárkészlet fémhez
RO Set de burghie pt. metal
FR Set de forets métal
IT Set punte per metallo
ES Juego de brocas para metal
CN 麻花钻组套

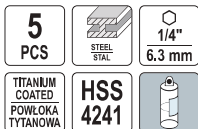

YATO	Ø [mm]	
YT-44700	4, 5, 6, 8, 10	30/60

EN Twist drill set
PL Komplet wiertel do metalu
DE Metallspiralbohrersatz
RU Набор сверл по металлу
CZ Souprava vrtáků na kov
HU Fúrószárkészlet fémhez
RO Set de burghie pt. metal
FR Set de forets métal
IT Set punte per metallo
ES Juego de brocas para metal
CN 麻花钻组套

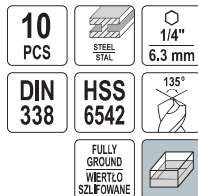

YATO	Ø [mm]	
YT-44888	1.5, 2.0, 2.5, 3.0, 3.5, 4.0, 4.5, 5.0, 5.5, 6.0	10/20

EN Twist drill set
PL Komplet wiertel do metalu
DE Metallspiralbohrersatz
RU Набор сверл по металлу
CZ Souprava vrtáků na kov
HU Fúrószárkészlet fémhez
RO Set de burghie pt. metal
FR Set de forets métal
IT Set punte per metallo
ES Juego de brocas para metal
CN 六角柄宝塔钻头刀薄板钻组套

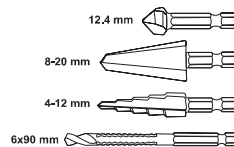
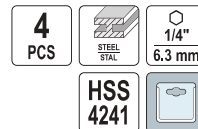

YATO	Ø [mm]	
YT-44705		12/24

EN Twist drill set
PL Komplet wiertel do metalu
DE Metallspiralbohrersatz
RU Набор сверл по металлу

CZ Souprava vrtáků na kov
HU Fúrószárkészlet fémhez
RO Set de burghie pt. metal
FR Set des forets métal

IT Set punte per metallo
ES Broca para metal
CN 全磨制麻花钻

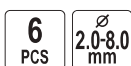

YATO	Ø [mm]	
YT-44673	2, 3, 4, 5, 6, 8	50/100

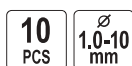

YATO	Ø [mm]	
YT-44674	1, 2, 3, 4, 5, 6, 7, 8, 9, 10	25/100



10

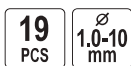

YATO	Ø [mm]	
YT-44675	1, 1.5, 2, 2.5, 3, 3.5, 4, 4.5, 5, 5.5, 6, 6.5, 7, 7.5, 8, 8.5, 9, 9.5, 10	6/30

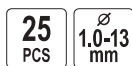

YATO	Ø [mm]	
YT-44676	1, 1.5, 2, 2.5, 3, 3.5, 4, 4.5, 5, 5.5, 6, 6.5, 7, 7.5, 8, 8.5, 9, 9.5, 10, 10.5, 11, 11.5, 12, 12.5, 13	5/20

EN Twist drill set
 PL Komplet wiertel do metalu
 DE Metallspiralbohrersatz
 RU Набор сверл по металлу
 CZ Souprava vrtáků na kov
 HU Fúrószárkészet fémhez
 RO Set de burghie pt. metal
 FR Foret métaux
 IT Set punte per metallo
 ES Broca para metal
 CN 轧制麻花钻



2 PCS
 ∅ 26, 28 mm

YATO	∅ [mm]	
YT-44627	26, 28	10



3 PCS
 ∅ 22-25 mm

YATO	∅ [mm]	
YT-44626	22, 24, 25	10



4 PCS
 ∅ 14-20 mm

YATO	∅ [mm]	
YT-44625	14, 16, 18, 20	10



5 PCS
 ∅ 10-15 mm

YATO	∅ [mm]	
YT-44622	10, 11, 12, 13, 15	10

EN Twist drill set
 PL Komplet wiertel do metalu
 DE Metallspiralbohrersatz
 RU Набор сверл по металлу
 CZ Souprava vrtáků na kov
 HU Fúrószárkészet fémhez
 RO Set de burghie pt. metal
 FR Set de forets métal
 IT Set punte per metallo
 ES Juego de brocas para metal
 CN 轧制麻花钻

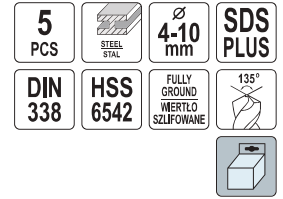

YATO	∅ [mm]	
YT-40050	4, 5, 6, 8, 10	24

EN Universal drill
 PL Wiertło uniwersalne
 DE Universalbohrer
 RU Универсальное сверло
 CZ Všeúčelový vrták
 HU Kőzet és többcéli fúró
 RO Burghiu universal cu coada hexagonala
 FR Forets polyvalents
 IT Punta universale
 ES Broca multimaterial
 CN 多功能冲击钻

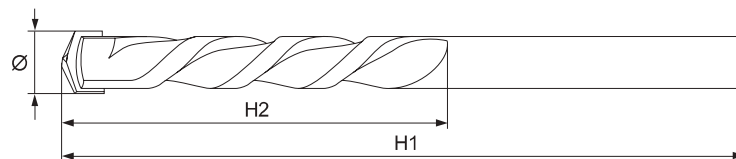
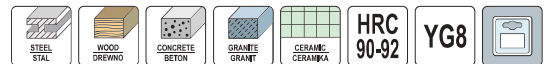

YATO	∅ [mm]	H1 [mm]	H2 [mm]	pcs / szt.	
YT-43940	3	60	35	1	100/600
YT-43941	4	75	40	1	100/600
YT-43942	5	85	50	1	100/600
YT-43943	6	100	60	1	100/400
YT-43960	6	400	240	1	25/100
YT-43944	7	100	60	1	100/400
YT-43945	8	120	70	1	50/400
YT-43962	8	400	240	1	25/100
YT-43946	10	150	90	1	50/200

YATO	∅ [mm]	H1 [mm]	H2 [mm]	pcs / szt.	
YT-43963	10	400	240	1	25/100
YT-43947	12	150	90	1	50/200
YT-43964	12	400	240	1	25/100
YT-43948	14	150	90	1	50/100
YT-43965	14	400	240	1	25/50
YT-43949	16	150	90	1	50/100
YT-43966	16	400	240	1	25/50
YT-43967	18	400	240	1	25
YT-43968	20	400	240	1	25

EN Universal drill
PL Wiertło uniwersalne
DE Universalbohrer
RU Универсальное сверло
CZ Visečůelový vrták
HU Kőzet és többcélú fúró
RO Burghiu universal cu coada hexagonală
FR Forets polyvalents
IT Punta universale
ES Broca multimaterial
CN 六角柄多功能钻

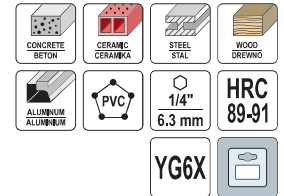
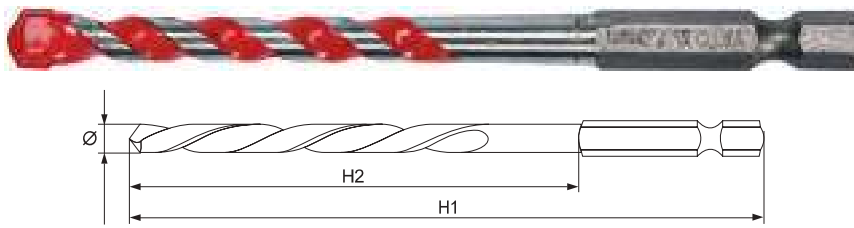

YATO	Ø [mm]	H1 [mm]	H2 [mm]	pcs / szt.	
YT-44780	3	85	30	1	125/250
YT-44781	4	85	30	1	125/250
YT-44782	5	85	30	1	125/250
YT-44783	6	85	30	1	125/250

YATO	Ø [mm]	H1 [mm]	H2 [mm]	pcs / szt.	
YT-44784	7	85	30	1	125/250
YT-44785	8	100	45	1	50/200
YT-44786	10	120	70	1	50/200
YT-44787	12	120	70	1	100/200

EN Universal drills
PL Zestaw wiertel uniwersalnych
DE Universalbohrer-Set
RU Набор универсальных сверл
CZ Sada visečůelových vrtáků
HU Keményfém többcélú fúró készlet
RO Set burghie universale
FR Jeu de forets universel
IT Set di punte universali
ES Juego de brocas universales
CN 六角柄多功能钻组套

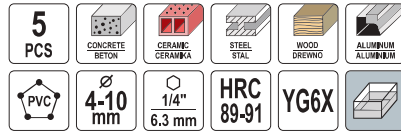

EN Universal drill bit set
PL Zestaw wiertel uniwersalnych
DE Universalbohrer-Set
RU Набор универсальных сверл
CZ Sada visečůelových vrtáků
HU Keményfém többcélú fúró készlet
RO Set burghie universale
FR Jeu de forets universel
IT Set di punte universali
ES Juego de brocas universales
CN 混合钻组套

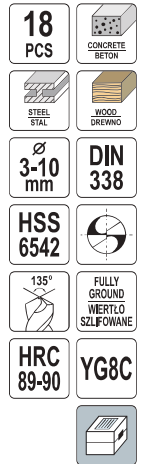

YATO	Ø [mm]	
YT-44789	4, 5, 6, 8, 10	25/100

YATO	Ø [mm]	
YT-43490	3, 4, 5, 6, 8, 10	20

EN Masonry drill bit X-TIP
PL Wiertło do betonu X-TIP
DE Betonspiralbohrer X-TIP
RU Сверло по бетону X-TIP
CZ Vrták na beton X-TIP
HU Fúrószár betonhoz X-TIP
RO Burghiu pt. beton X-TIP
FR Foret béton à pointe en croix
IT Punta per cemento X-TIP
ES Broca para hormigón X-TIP
CN 十字头电锤钻

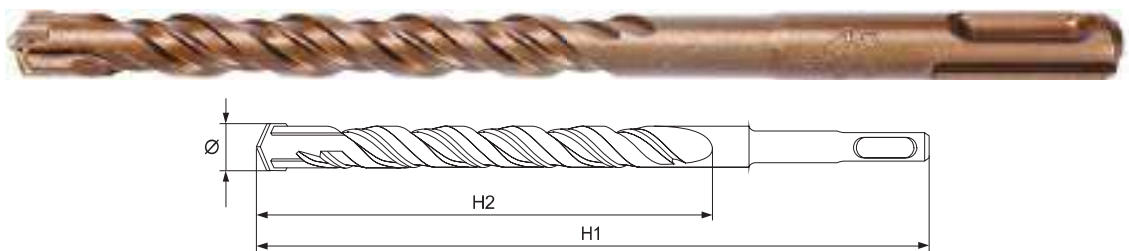

YATO	Ø [mm]	H1 [mm]	H2 [mm]	PCS ROZB.	
YT-4200	5	110	45	10	300
YT-4201	6	110	45	10	300
YT-4202	6	160	95	10	200
YT-4203	6	210	135	10	150
YT-42033	6	300	220	-	10/100
YT-4204	8	110	45	10	300
YT-4205	8	160	95	10	200
YT-4206	8	210	140	10	150
YT-42063	8	300	220	-	10/100
YT-4207	8	460	370	10	50
YT-4208	8	600	500	10	50
YT-4209	10	160	95	10	150
YT-4210	10	210	140	10	150
YT-4211	10	300	220	10	100
YT-4212	10	460	370	10	50
YT-4213	10	600	500	10	50
YT-4214	12	160	95	10	150

YATO	Ø [mm]	H1 [mm]	H2 [mm]	PCS ROZB.	
YT-4215	12	260	185	10	100
YT-42153	12	300	220	-	10/100
YT-4216	12	460	360	10	50
YT-4217	12	600	490	10	40
YT-4218	14	260	180	10	80
YT-4219	14	460	360	10	40
YT-4220	16	200	125	10	60
YT-4221	16	460	360	10	20
YT-4222	16	600	490	10	20
YT-4223	18	460	360	10	20
YT-4224	18	600	490	10	20
YT-4225	20	460	360	5	20
YT-4226	20	600	490	5	20
YT-4227	22	460	360	5	20
YT-4228	22	600	490	5	20
YT-4229	25	460	360	5	20
YT-4230	25	600	490	5	10

EN Masonry drill bit
 PL Wiertło do betonu
 DE Betonspiralbohrer
 RU Цеepно no бетoны
 CZ Vrták na beton
 HU Fúrószár betonhoz
 RO Burghiu pt. beton
 FR Foret béton
 IT Punta per cemento
 ES Broca para hormigón
 CN 三尖电锤钻

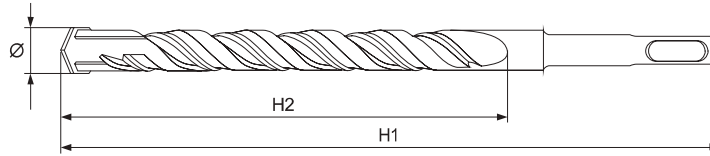

YATO	Ø [mm]	H1 [mm]	H2 [mm]	PCS PER PKG	
YT-4161	5	110	45	10	300
YT-4162	6	110	45	10	300
YT-4163	6	160	95	10	200
YT-4164	6	210	140	10	150
YT-4165	8	110	45	10	300
YT-4166	8	160	90	10	200
YT-4167	8	210	140	10	150
YT-4168	8	460	370	10	50
YT-4169	8	600	500	10	50
YT-4170	10	160	95	10	150
YT-4171	10	210	140	10	150
YT-4172	10	300	220	10	100
YT-4173	10	460	370	10	50
YT-4174	10	600	500	10	50
YT-4175	12	160	85	10	150
YT-4176	12	260	180	10	100

YATO	Ø [mm]	H1 [mm]	H2 [mm]	PCS PER PKG	
YT-4177	12	460	360	10	50
YT-4178	12	600	490	10	40
YT-4179	14	260	180	10	80
YT-4180	14	460	360	10	40
YT-4181	16	200	125	10	60
YT-4182	16	300	220	10	50
YT-4183	16	460	360	10	20
YT-4184	16	600	490	10	20
YT-4185	18	460	360	10	20
YT-4186	18	600	490	10	20
YT-4187	20	460	360	5	20
YT-4188	20	600	490	5	20
YT-4189	22	460	360	5	20
YT-4190	22	600	490	5	20
YT-4191	25	460	360	5	20
YT-4192	25	600	490	5	10

EN Masonry drill bit
 PL Wiertło do betonu
 DE Betonspiralbohrer
 RU Цеepно no бетoны
 CZ Vrták na beton
 HU Fúrószár betonhoz
 RO Burghiu pt. beton
 FR Foret béton
 IT Punta per cemento
 ES Broca para hormigón
 CN 三尖电锤钻

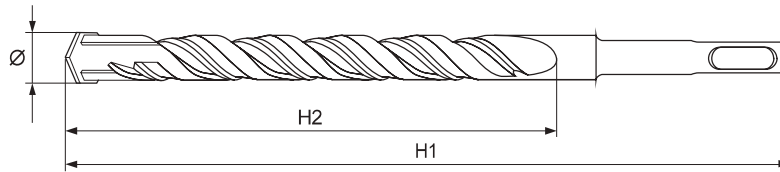

- For windows assembly
- Without necessity of using screw anchors
- Do montażu okien
- Bez użycia kołków rozporowych

YATO	Ø [mm]	H1 [mm]	H2 [mm]	PCS PER PKG	
YT-41641	6.5	200	130	10	10/150
YT-41642	6.5	260	183	10	10/150

EN Masonry drill bit
 PL Wiertło do betonu
 DE Betonspiralbohrer
 RU Цеepно no бетoны
 CZ Vrták na beton
 HU Fúrószár betonhoz
 RO Burghiu pt. beton
 FR Foret béton
 IT Punta per cemento
 ES Broca para hormigón
 CN 十字刀头电锤钻

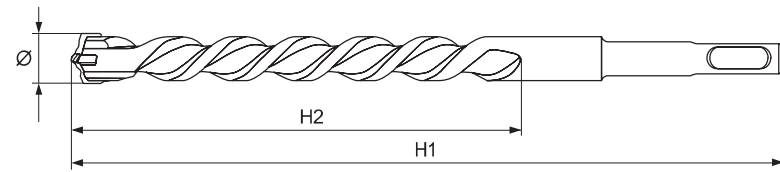

- Resistant for stack in SDS chuck
- DD carbide tip
- Automatic soldering
- Odporne na zakleszczenie w uchwycie SDS
- Widia DD carbide
- Automatyczne lutowanie



YATO	Ø [mm]	H1 [mm]	H2 [mm]	
YT-41930	5	110	50	40/160
YT-41935	5	160	100	40/160
YT-41931	6	110	50	40/160
YT-41936	6	160	100	40/160
YT-41942	6	210	150	40/160
YT-419503	6	300	250	40/160
YT-41951	6	460	375	30/120
YT-41960	6	600	525	25/100
YT-41932	7	110	50	40/160
YT-41937	7	160	100	40/160
YT-41933	8	110	50	40/160
YT-41938	8	160	100	40/160
YT-41943	8	210	150	40/160
YT-419504	8	300	250	20/160
YT-41952	8	460	375	30/120
YT-41961	8	600	525	20/80
YT-41939	9	160	100	40/160

YATO	Ø [mm]	H1 [mm]	H2 [mm]	
YT-41944	9	210	150	40/160
YT-41934	10	110	50	40/160
YT-41940	10	160	100	40/160
YT-41945	10	210	150	30/120
YT-419505	10	300	250	20/160
YT-41953	10	460	375	30/120
YT-41962	10	600	525	20/80
YT-41941	12	160	100	40/160
YT-41946	12	210	150	30/120
YT-419506	12	300	245	20/160
YT-41954	12	460	375	20/80
YT-41963	12	600	525	15/60
YT-41969	12	1000	930	25
YT-41954	12	460	375	20/80
YT-41963	12	600	525	15/60
YT-41969	12	1000	930	25
YT-41947	14	210	150	20/80
YT-41955	14	460	375	20/80
YT-41964	14	600	525	15/60
YT-41970	14	1000	930	20

YATO	Ø [mm]	H1 [mm]	H2 [mm]	
YT-41948	16	210	150	20/80
YT-41956	16	460	375	15/60
YT-41965	16	600	525	10/40
YT-41971	16	1000	930	20
YT-41949	18	210	150	20/80
YT-41957	18	460	375	10/40
YT-41966	18	600	525	5/20
YT-41972	18	1000	930	15
YT-41950	22	210	150	20/80
YT-41958	22	460	375	8/32
YT-41967	22	600	525	5/20
YT-41973	22	1000	930	15
YT-41959	25	460	375	8/32
YT-41968	25	600	525	5/20
YT-41974	25	1000	930	15

EN Masonry drill bit
PL Wiertło do betonu
DE Betonspiralbohrer
RU Свёрно по бетону
CZ Vrták na beton
HU Fúrószár betonhoz

RO Burghiu pt. beton
FR Foret béton
IT Punta per cemento
ES Broca para hormigón
CN 建工钻

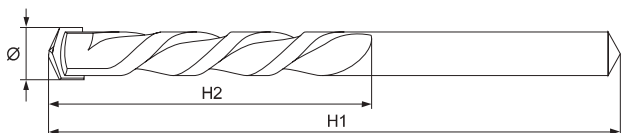
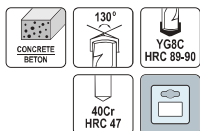

YATO	Ø [mm]	H1 [mm]	H2 [mm]	Box
YT-4361	4	70	35	100/400
YT-4362	5	90	50	100/400
YT-4363	6	100	60	100/400
YT-4364	6	150	100	100/400
YT-4367	7	100	60	75/300
YT-4369	8	120	80	75/300
YT-4370	8	200	140	50/150

YATO	Ø [mm]	H1 [mm]	H2 [mm]	Box
YT-4375	10	120	80	75/300
YT-4376	10	200	140	50/150
YT-4379	12	150	100	50/150
YT-4380	12	200	140	50/150
YT-4383	14	180	120	25/100
YT-4385	16	180	120	25/100

EN Masonry drill bit set
PL Komplet wiertel do betonu
DE Betonspiralbohrersatz
RU Свёрно по бетону в наборе
CZ Souprava vrtáků do betonu
HU Fúrószárkészlet betonhoz
RO Set de burghie pt. beton
FR Set des forets béton
IT Set punte per cemento
ES Brocas para hormigón
CN 建工钻组套

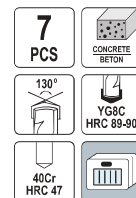

YATO	Ø [mm]	Box
YT-4390	4, 5, 6, 8, 9, 10, 12	10/80

EN Flat wood drill bit
PL Wiertło łopatkowe do drewna
DE Schaufelbohrer
RU Перовые сверло
CZ Ploché vrták
HU Homlokmarós fúró
RO Burghiu plate
FR Mèche à bois plate
IT Punta per legno piatta
ES Broca de aletas
CN 木工扁钻

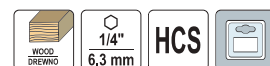
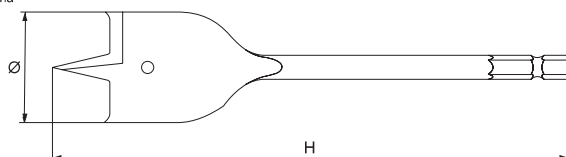

YATO	Ø [mm]	H [mm]	Box
YT-3236	6	152	50/400
YT-3237	8	152	50/400
YT-3238	10	152	50/300
YT-3239	12	152	50/300
YT-3240	13	152	50/300
YT-3241	14	152	50/300
YT-3242	16	152	50/300

YATO	Ø [mm]	H [mm]	Box
YT-3243	18	152	50/300
YT-3244	20	152	50/300
YT-3245	22	152	50/300
YT-3246	24	152	50/300
YT-3247	25	152	50/300
YT-3248	26	152	50/300
YT-3249	28	152	50/300

YATO	Ø [mm]	H [mm]	Box
YT-3250	30	152	50/200
YT-3251	32	152	50/200
YT-3252	34	152	50/200
YT-3253	35	152	50/200
YT-3254	38	152	50/200
YT-3255	40	152	50/200

EN Extension for flat wood drill bits
PL Przedłużka do wiertel łopatkowych, bitów i wiertel
DE Verlängerung für Schaufelbohrer
RU Удлинитель для перовых сверл
CZ Nástavec pro ploché vrtáky
HU Hosszabbító homlokmarós fúrókhoz
RO Prelungitor pt. burghie plate
FR Rallonge pour mèches à bois
IT Prolunga per punta fresatrice
ES Extensión para brocas de aletas
CN 木工扁钻延长杆

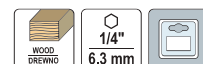
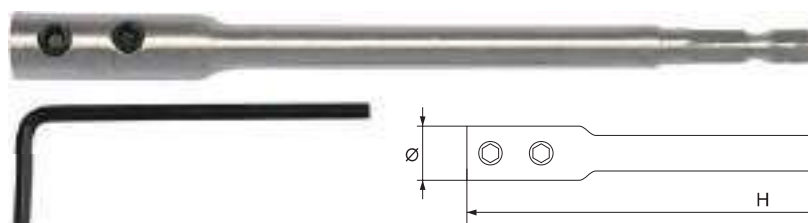

YATO	Ø [mm]	H [mm]	Box
YT-3256	12.2	150	60/120
YT-3257	13.5	300	30/60

EN Flat wood drill bit set
PL Zestaw wiertel łopatkowych
DE Schaufelbohrersatz
RU Набор перовых сверл
CZ Sada plochých vrtáků
HU Homlokmarós fúró készlet
RO Set burghie plate
FR Set de mèche à bois
IT Set di punte per legno piatta
ES Juego de brocas de aletas
CN 木工扁钻组套

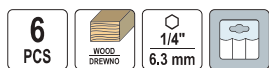

YATO	Ø [mm]	H [mm]	Box
YT-3258	10, 12, 16, 18, 20, 25	152	25/50

EN Flat wood drill bit set
PL Zestaw wiertel łopatkowych
DE Schaufelbohrersatz
RU Набор перовых сверл
CZ Sada plochých vrtáků
HU Homlokmarós fúró készlet

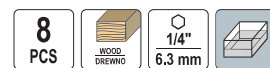

YATO	Ø [mm]	H [mm]	Box
YT-3259	12, 16, 18, 20, 22, 25, 28, 32	152	5/20

EN Spur wood drill bit
 PL Wiertło do drewna spiralne
 DE Spiralbohrer für Holz
 RU Спиральное сверло по дереву
 CZ Vrták do dřeva spirálový
 HU Csigaűró fához
 RO Burghiu spirală pt. lemn
 FR Méches hélicoïdales à bois
 IT Punta per legno spirale
 ES Barrena para madera espiral
 CN 木工钻

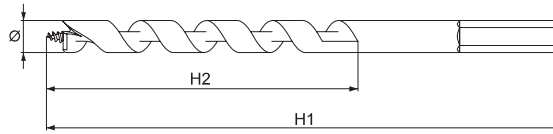

YATO	Ø [mm]	H1 [mm]	H2 [mm]	
YT-4350	3	60	35	30/300
YT-4351	4	75	44	30/300
YT-4352	5	85	52	30/300
YT-4353	6	90	57	30/300

YATO	Ø [mm]	H1 [mm]	H2 [mm]	
YT-4354	7	100	67	30/300
YT-4355	8	110	75	30/300
YT-4356	10	120	77	30/300
YT-4357	12	150	97	15/120

YATO	Ø [mm]	H1 [mm]	H2 [mm]	
YT-4358	13	150	102	15/120
YT-4359	16	160	120	15/120

EN Spur wood drill bit
 PL Wiertło do drewna spiralne
 DE Spiralbohrer für Holz
 RU Спиральное сверло по дереву
 CZ Vrták do dřeva spirálový
 HU Csigaűró fához
 RO Burghiu spirală pt. lemn
 FR Méches hélicoïdales à bois
 IT Punta per legno spirale
 ES Barrena para madera espiral
 CN 木工钻

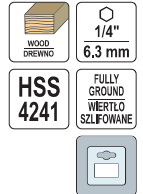
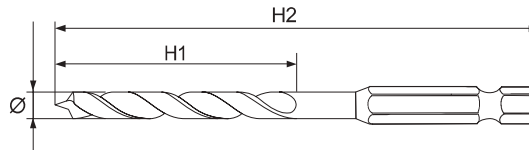

YATO	Ø [mm]	H1 [mm]	H2 [mm]	
YT-33860	3	61	33	125/500
YT-33861	4	75	43	125/500
YT-33862	5	86	52	75/300
YT-33863	6	93	57	75/300

YATO	Ø [mm]	H1 [mm]	H2 [mm]	
YT-33864	7	109	69	75/300
YT-33865	8	117	75	75/300
YT-33866	10	133	87	75/300
YT-33867	12	151	101	75/300

YATO	Ø [mm]	H1 [mm]	H2 [mm]	
YT-33868	13	151	101	50/200
YT-33869	14	160	108	50/200
YT-33870	16	178	120	50/200

10

EN Spur wood drill set
 PL Zestaw wiertel spiralnych do drewna
 DE Holzspiralbohrer-Set
 RU Набор спиральных сверел по дереву
 CZ Sada spirálových vrtáků do dřeva
 HU Spirál faűrószár készlet
 RO Set burghie pt. lemn
 FR Jeu de forets à spirale pour bois
 IT Set di punte spirali per legno
 ES Juego de brocas espirales para la madera
 CN 高速钢整体木工钻组套

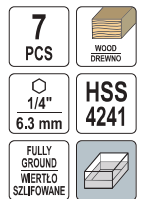

YATO	Ø [mm]	
YT-33873	3, 4, 5, 6, 7, 8, 10	20/80

EN Auger drill bit hex
 PL Wiertło do drewna 4-ostrzowe Hex
 DE 4-flöte Schlangenbohrer
 RU Сверло по дереву Hex с 4 режущими кромками
 CZ Vrták do dřeva
 HU Auger faűrószár bit befogással
 RO Burghiu sfredel
 FR 4 diamètre ébénisterie bois foret
 IT Punta esagonale per legno
 ES Broca espiral de madera Hex
 CN 四槽木工钻

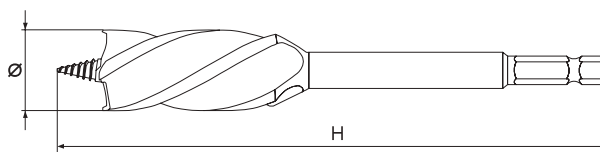

YATO	Ø [mm]	H [mm]	
YT-44680	10	165	100/200
YT-44681	12	165	100/200
YT-44682	14	165	100/200
YT-44683	16	165	100/200

YATO	Ø [mm]	H [mm]	
YT-44684	18	165	75/150
YT-44685	20	165	75/150
YT-44686	22	165	50/100
YT-44687	25	165	50/100

YATO	Ø [mm]	H [mm]	
YT-44688	28	165	50/100
YT-44689	30	165	50/100
YT-44690	32	165	50/100

- EN Auger drill bit set
- PL Zestaw wiertel do drewna 4-ostrzowych Hex
- DE Schlangenbohrer 4-flöte Set
- RU Набор сверл по дереву с 4 режущими кромками
- CZ Sada vrtáků do dřeva
- HU Auger fafűrösár bit befogással készlet
- RO Set burghiu sfredel
- FR Coffret 4 diamètre ébénisterie bois foret
- IT Set di punte esagonali per legno
- ES Juego de brocas espiral de madera Hex
- CN 木工钻



7
PCS

WOOD
DREWNO

1/4"
6.3 mm

HRC
40-45

1/4" (6.3 mm): 16, 18, 20, 22, 25 mm (L=165 mm);
1/4" (6.3 mm); (300 mm);

YATO

YT-44693

10/20

- EN Auger wood drill bit
- PL Świder do drewna
- DE Holzbohrer
- RU Бур по дереву
- CZ Vrták do dřeva hadovitý
- HU Fafűrő
- RO Burghiu elicoidal pt. lemn
- FR Foret spirale à bois
- IT Punta a torciglione per legno
- ES Barrena para madera
- CN 螺旋木工钻



WOOD
DREWNO

13 mm

Ø

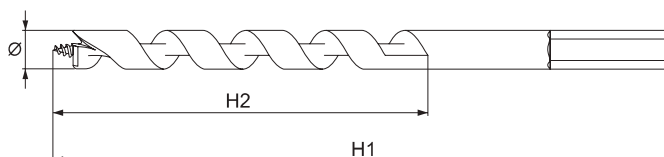

YATO	Ø [mm]	H1 [mm]	H2 [mm]	
YT-3261	6	230	150	150/300
YT-3262	8	230	150	140/280
YT-3263	8	460	360	60/120
YT-3264	10	230	150	100/200
YT-3265	10	460	360	50/100
YT-3266	12	190	150	75/150
YT-3267	12	460	360	30/60
YT-3268	13	230	150	50/100
YT-3269	13	400	310	30/60
YT-3270	14	191	150	50/100
YT-3271	14	460	360	30/60
YT-3272	16	230	150	50/100
YT-3273	16	460	360	20/40

YATO	Ø [mm]	H1 [mm]	H2 [mm]	
YT-3274	18	230	150	40/80
YT-3275	18	460	360	20/40
YT-3276	20	230	150	30/60
YT-3277	20	460	360	20/40
YT-3278	22	230	150	20/60
YT-3279	22	460	360	15/30
YT-3280	24	230	150	30/60
YT-3281	24	460	360	15/30
YT-3282	25	230	150	20/40
YT-3283	25	460	360	15/30
YT-3284	26	230	150	20/40
YT-3285	26	460	360	10/20
YT-3286	28	230	150	10/20

YATO	Ø [mm]	H1 [mm]	H2 [mm]	
YT-3287	28	460	360	10/20
YT-3288	30	230	150	10/20
YT-3289	30	460	360	5/10
YT-3290	32	230	150	10/20
YT-3291	32	460	360	5/10
YT-3292	35	230	150	10/20
YT-3293	35	460	360	5/10
YT-3294	36	230	150	10/20
YT-3295	36	460	360	5/10
YT-3296	38	230	150	10/20
YT-3297	40	230	360	10/20

- EN Auger wood drill bit set
- PL Zestaw świderów do drewna
- DE Holzbohrersatz
- RU Набор буров по дереву
- CZ Sada hadovitých vrtáků do dřeva
- HU Fafűrő készlet
- RO Set de burghie elicoidale pt. lemn
- FR Set de forets spirales à bois
- IT Set di punte a torciglione
- ES Juego de barrenas para madera
- CN 螺旋木工钻组套

6
PCS

WOOD
DREWNO



13 mm

Ø



13 mm

Ø



SDS
PLUS

YATO	Ø [mm]	H [mm]	
YT-3299	10, 12, 14, 16, 18, 20	460	8

YATO	Ø [mm]	H [mm]	
YT-3298	10, 12, 14, 16, 18, 20	230	15

YATO	Ø [mm]	H [mm]	
YT-3300	10, 12, 14, 16, 18, 20	230	20

- EN Conformat screw drill bit
- PL Wiertło do konfirmatów
- DE Konfirmatbohrer
- RU Сверло под конфирмат
- CZ Vrták na konfirmáty
- HU Konfirmátor csavar ekőfúró
- RO Burghiu tip pt. mobilier
- FR Foret à vis confirmat
- IT Avvitatore per viti di assemblaggio mobili
- ES Broca para tornillos confirmat
- CN 倒角器木工钻

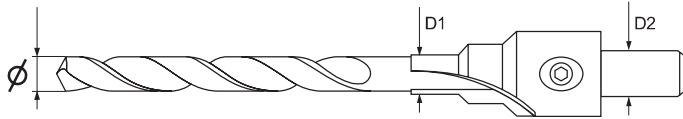

YATO	Ø [mm]	D1 [mm]	D2 [mm]	Box
YT-33021	4	7	8	25/250
YT-33022	5	7	8	25/250
YT-33023	7	10	8	25/250

- EN Drill for ceramic tiles
- PL Wiertło do ceramiki i gresu
- DE Keramik und Fliesen Bohr
- RU Бурильные плитки и керамики
- CZ Vrtací tašek a keramických výrobků
- HU Fúró cserép és kerámia
- RO Burghiu pt. ceramica si sticla
- FR Tuelles de forage et de la céramique
- IT Piastrelle e ceramiche trapano
- ES Azulejos y cerámicas de perforación
- CN 玻璃钻



YATO	Ø [mm]	Box
YT-3725	4	100/400
YT-3726	6	100/400

YATO	Ø [mm]	Box
YT-3727	8	100/400
YT-3728	10	50/200

- EN Diamond tile drill bit
- PL Koronka diamentowa
- DE Diamantbohrkrone für Winkelschleifer
- RU Алмазная коронка
- CZ Diamantová korunka
- HU Gyémánt koronafúró
- RO Burghiu diamant
- FR Trépan diamant
- IT Punta a corona diamantata
- ES Broca diamante
- CN 金刚石电镀薄壁钻

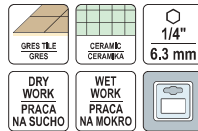

YATO	Ø [mm]	c [min ⁻¹]	Box
YT-60401	6	1500	50/200
YT-60402	8	1500	50/200
YT-60403	10	1500	50/200

- EN Diamond tile drill bit
- PL Koronka diamentowa
- DE Diamantbohrkrone für Winkelschleifer
- RU Алмазная коронка
- CZ Diamantová korunka
- HU Gyémánt koronafúró
- RO Burghiu diamant
- FR Trépan diamant
- IT Punta a corona diamantata
- ES Broca diamante
- CN 金刚石电镀薄壁钻



YATO	Ø [mm]	c [min ⁻¹]	Box
YT-60409	6, 8, 10	1500	20/80

- EN Diamond tile drill bit
- PL Koronka diamentowa
- DE Diamantbohrkrone für Winkelschleifer
- RU Алмазная коронка
- CZ Diamantová korunka
- HU Gyémánt koronafúró
- RO Burghiu diamant
- FR Trépan diamant
- IT Punta a corona diamantata
- ES Broca diamante
- CN 金刚石电镀薄壁钻



YATO	Ø [mm]	c [min ⁻¹]	Box
YT-60421	5	600	50/400
YT-60422	6	600	50/400
YT-60423	8	600	50/400
YT-60424	10	600	50/500
YT-60425	12	600	50/200
YT-60426	14	600	50/200
YT-60427	16	600	50/200
YT-60428	20	500	25/100
YT-60429	25	500	25/100
YT-60430	30	500	25/100
YT-60431	40	500	15/60
YT-60432	50	400	15/60
YT-60433	68	400	8/40
YT-60434	80	400	5/25
YT-60435	105	400	4/20
YT-60436	125	400	4/20

- EN Dry diamond tile drill bit
PL Koronka diamentowa
DE Diamantbohrkrone für Winkelschleifer
RU Алмазная коронка
CZ Diamantová korunka
HU Gyémánt koronafűró
RO Burghiu diamant
FR Trépan diamant
IT Punta a corona diamentata
ES Broca diamante
CN 钎焊薄壁钻



YATO	Ø [mm]	v [min ⁻¹]	
YT-60441	6	12200	100/200
YT-60442	8	12200	100/200
YT-60443	10	12200	100/200
YT-60444	20	12200	100/200
YT-60445	30	12200	50/100
YT-60446	51	12200	40/80
YT-60447	68	12200	50

- EN Adjustable hand reamer
PL Rozwiertak nastawny
DE Verstellbare Reibahle
RU Регулируемая развертка
CZ Nastavitelný výstružník
HU Állítható dörzsár
- RO Alezor reglabil
FR Alesoir à main réglable
IT Alesatore regolabile
ES Escariador ajustable
CN 可调式手动铰刀



YATO	Working diameter / Średnica robocza [mm ²]	L [mm]	Arbor diameter / Średnica trzpienia [mm ²]	
YT-28950	7.75-8.5	107	4.5	50/200
YT-28951	8.5-9.25	112	4.5	50/200
YT-28952	9.25-10	116	5.0	50/200
YT-28953	10-10.75	125	5.5	50/200
YT-28954	10.75-11.75	130	6.5	50/200
YT-28955	11.75-12.75	135	7.5	50/150
YT-28956	12.75-13.75	140	7.5	50/150
YT-28957	13.75-15.25	158	8.0	20/60
YT-28958	15.25-17	165	9.0	20/60

YATO	Working diameter / Średnica robocza [mm ²]	L [mm]	Arbor diameter / Średnica trzpienia [mm ²]	
YT-28959	17-19	175	10.0	20/60
YT-28960	19-21	180	11.5	20/60
YT-28961	21-23	193	13.5	20/60
YT-28962	23-26	210	15.4	4/20
YT-28963	26-29.5	245	17.0	4/20
YT-28964	29.5-33.5	270	19.0	4/20
YT-28965	33.5-38	310	21.0	2/10
YT-28966	38-44	345	24.0	2/10
YT-28967	44-54	400	30.0	5

- EN Straight hole doweling jig kit
PL Uchwyt do wiercenia prostopadłego
DE Bohrschablone zum senkrechten Vorbohren
RU Ручка для перпендикулярного сверления
CZ Rukojeť pro kolmé vrtání
HU Fúrósablon merőleges fúrászhoz
RO Kit pt. gaurit
FR Guide de perçage mobile
IT Mandrino per foratura verticale
ES Soporte para perforación perpendicular
CN 打孔定位器



YATO	Ø [mm]	
YT-39700	4, 5, 6, 8, 10, 12	40

- EN Depth collars for drills
PL Ogranicznik głębokości wiercenia
DE Bohrtiefenbegrenzer
RU Ограничитель глубины для сверл
CZ Omezovač hloubky vrtáku
HU Mélységűtköző
RO Limitator adancime pt. burghiu
FR Butées de profondeur
IT Arresto di profondità
ES Tope de profundidad para brocas
CN 木工定位器



YATO	Ø [mm]	
YT-44100	6, 8, 10	250/500

- EN Dowelling centre points
PL Znaczniki do wyznaczania otworów
DE Holzdübel-Markierspitzen
RU Набор кернов для мебельных шкантов
CZ Značící hroty pro kolikování
HU Típlí jetelő
RO Cep pt. centrare
FR Centreaurs
IT Set centrorali per spine
ES Centradores
CN 木工顶尖



YATO	Ø [mm]	
YT-44104	6	25/100
YT-44105	8	25/100
YT-44106	10	25/100

EN Dowel set
 PL Zestaw do połączeń kółkowych
 DE Holzdübeln-Werkzeugsatz
 RU Набор для соединения на шкантах
 CZ Kolkovací sada
 HU Facsapozó készlet
 RO Set pt. imbinari cu dibluri lemni
 FR Kit d'assemblage bois en mains libres
 IT Set di spinatura in legno
 ES Juego para ensamblaje de madera
 CN 木工顶尖

17
PCS
6.0
mm



6x40 mm (10 PCS);
 6 mm (4 PCS);
 6 mm;
 2.5 mm;
 6x100 mm

YATO	Ø [mm]	
YT-44112	6	4/100

EN Dowel set
 PL Zestaw do połączeń kółkowych
 DE Holzdübeln-Werkzeugsatz
 RU Набор для соединения на шкантах
 CZ Kolkovací sada
 HU Facsapozó készlet
 RO Set pt. imbinari cu dibluri lemni
 FR Kit d'assemblage bois en mains libres
 IT Set di spinatura in legno
 ES Juego para ensamblaje de madera
 CN 木工顶尖

17
PCS
8.0
mm



8x40 mm (10 PCS);
 8 mm (4 PCS);
 8 mm;
 2.5 mm;
 8x100 mm

YATO	Ø [mm]	
YT-44111	8	4/100

EN Dowel set
 PL Zestaw do połączeń kółkowych
 DE Holzdübeln-Werkzeugsatz
 RU Набор для соединения на шкантах
 CZ Kolkovací sada
 HU Facsapozó készlet
 RO Set pt. imbinari cu dibluri lemni
 FR Kit d'assemblage bois en mains libres
 IT Set di spinatura in legno
 ES Juego para ensamblaje de madera
 CN 木工顶尖

17
PCS
10
mm



10x40 mm (10 PCS);
 10 mm (4 PCS);
 10 mm;
 2.5 mm;
 10x100 mm

YATO	Ø [mm]	
YT-44113	10	4/100

EN Dowel set
 PL Zestaw do połączeń kółkowych
 DE Holzdübeln-Werkzeugsatz
 RU Набор для соединения на шкантах
 CZ Kolkovací sada
 HU Facsapozó készlet
 RO Set pt. imbinari cu dibluri lemni
 FR Kit d'assemblage bois en mains libres
 IT Set di spinatura in legno
 ES Juego para ensamblaje de madera
 CN 木工定位木销组套

154
PCS
6, 8, 10
mm

METAL
TEMPLATE
SZABLON
METALOWY
GUIDE
PROWADNICA
ANGLE
STOP
OGRA NICZNIK
KĄTOWY



Doweling jig / Prowadnica do nawiercania otworów:
 Ø 3, 3.3, 4, 4.2, 5, 6, 6.8, 8, 10, 12 mm
 6x30 mm (50 PCS), 8x40 mm (50 PCS), 10x40 mm (50 PCS);
 6, 8, 10 mm

YATO	Ø [mm]	
YT-44122	6, 8, 10	2/10

EN Drill gauge and depth stop set
 PL Sprawdzian do średnic i ograniczniki głębokości
 DE Durchmesserlehre und Tiefenanschlag
 RU Измеритель диаметра и ограничитель глубины
 CZ Měřidla průměru a hloubkové dorazy
 HU Átmérőellenőrző és mélységátaroló
 RO Set sablon gaurire cu opritor
 FR Jauges de diamètre et butées de profondeur
 IT Calibro per diametri e limitatori di profondità
 ES Calibre de diámetros y limitador de brocas
 CN 钻头量规

10
PCS
1/16"-1/2"
1.0-13mm

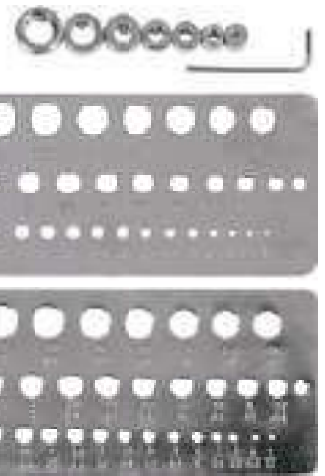

3, 4, 5, 6, 8, 10, 12 mm;
 1.5 mm

YATO	Ø	
YT-44095	1/16"-1/2" / 1.0-13 mm	20/60

EN Drill guider with handle
 PL Przyrząd do połączeń kółkowych
 DE Dübel Bohrschablone
 RU Кондуктор для сверления отверстий
 CZ Kolkovací přípravek
 HU Típliző fúrósablon
 RO Sablon pt. dibluri lemni
 FR Guide de perçage pour assemblage par tourillons
 IT Dima per spinatura legno
 ES Guía de perforación
 CN 摆臂斜孔定位器

6, 8, 10
mm
AI



YATO	Ø [mm]	
YT-44120	6, 8, 10	10

EN Tool drill guide
 PL Szablon do wyznaczania otworów
 DE Schablone zur Markierung von Löchern
 RU Шаблон для разметки отверстий
 CZ Šablona pro značení otvorů
 HU Nyílássablon
 RO Instrument ghidare pt. gaurire
 FR Gabarit pour le marquage des trous
 IT Sagoma per fori
 ES Plantilla para determinar perforaciones
 CN 打孔定位工具

250
mm
AI

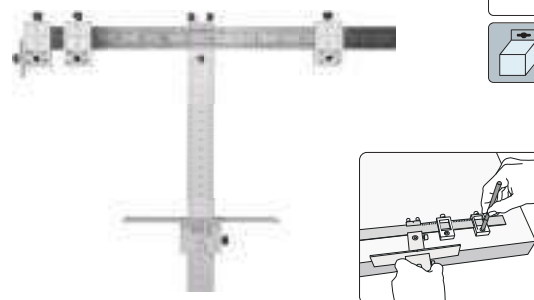

YATO		
YT-44130		20

EN Point chisel SDS Plus RU Зубило SDS Plus RO Punctator SDS Plus ES Cincel puntiaguado SDS Plus
PL Przecinak SDS Plus CZ Sekáč špičák SDS Plus FR Perçoir SDS Plus CN 尖凿
DE Spitzmeißel SDS Plus HU Hegyes véső SDS Plus IT Scalpello a punta SDS Plus



YATO 	L [mm]	
YT-4720	250	6/48

EN Wood chisel SDS Plus RU Долото столярски SDS Plus RO Daltă de tâmplărie SDS Plus ES Cincel para madera SDS Plus
PL Dłuto do drewna SDS Plus CZ Rezbářské dláto SDS Plus FR Ciseau SDS Plus CN 木工凿
DE Stechbeitel SDS Plus HU Asztafos véső SDS Plus IT Scalpello SDS Plus



YATO 	L [mm]	
YT-4720	180	10/80

EN Flat chisel SDS Plus RU Долото узкое SDS Plus RO Punctator pt. adancit SDS Plus ES Cincel plano estrecho SDS Plus
PL Dłuto wąskie SDS Plus CZ Sekáč plochý SDS Plus FR Ciseau SDS Plus CN 平凿
DE Flachmeißel SDS Plus HU Lapos véső SDS Plus IT Scalpello piatto SDS Plus, punta stretta



YATO 	L [mm]	
YT-4721	250	6/48

EN Hollow chisel SDS Plus RU Бороздник SDS Plus RO Punctator pt. adancit SDS Plus ES Cincel acanalado SDS Plus
PL Bruzdownik SDS Plus CZ Sekáč drážkovací SDS Plus FR Burin à entailler SDS Plus CN 空心凿
DE Nutenmeißel SDS Plus HU Horonyvéső SDS Plus IT Scalpello per scanalature SDS Plus



YATO 	L [mm]	
YT-4722	250	6/48

EN Flat chisel SDS Plus RO Punctator tip dalta SDS Plus
PL Dłuto płaskie SDS Plus FR Ciseau SDS Plus
DE Spatmeißel SDS Plus IT Scalpello piatto SDS Plus
RU Долото плоское SDS Plus ES Cincel plano SDS Plus
CZ Sekáč plochý SDS Plus CN 扁凿
HU Széles lapos véső SDS Plus



YATO 	L [mm]	
YT-4723	250	6/48

EN Flat chisel SDS Plus RO Punctator tip dalta SDS Plus
PL Dłuto płaskie SDS Plus FR Ciseau SDS Plus
DE Spatmeißel SDS Plus IT Scalpello piatto SDS Plus
RU Долото плоское SDS Plus ES Cincel plano SDS Plus
CZ Sekáč plochý SDS Plus CN 扁凿
HU Széles lapos véső SDS Plus



YATO 	L [mm]	
YT-47212	250	10/20

EN Groove chisel RO Dalta canal
PL Bruzdownik FR Burin à entailler
DE Nutenmeißel IT Scalpello per scanalature
RU Зубило канавочное ES Cincel acanalado
CZ Sekáč drážkovací CN 五坑蝴蝶凿
HU Horonyvéső





YATO 	L [mm]	
YT-47331	300	10/30

EN Groove chisel
 PL Bruzdownik
 DE Nutenmeißel
 RU Зубило канавочное
 CZ Sekáč drážkovací
 HU Horonyvő

RO Dalta canal
 FR Burin a entailler
 IT Scalpello per scanalature
 ES Cincel acanalado
 CN 五坑蝴蝶凿





YATO 	L [mm]	
YT-47330	380	10/20

EN Spade chisel
 PL Diuto szerokie
 DE Spatmeißel
 RU Лопатка
 CZ Sekáč plochý
 HU Széles véső

RO Dalta
 FR Burin plat large
 IT Scalpello largo
 ES Cincel pala
 CN 五坑扁凿





YATO 	L [mm]	
YT-47336	400	10/20

EN Spade chisel
 PL Diuto szerokie
 DE Spatmeißel
 RU Лопатка
 CZ Sekáč plochý
 HU Széles véső

RO Dalta
 FR Burin plat large
 IT Scalpello largo
 ES Cincel pala
 CN 五坑扁凿



YATO 	L [mm]	
YT-47335	300	10/20

EN Spade chisel
 PL Diuto płaskie
 DE Spatmeißel
 RU Лопатка
 CZ Sekáč plochý
 HU Széles véső

RO Dalta
 FR Burin plat large
 IT Scalpello piatto
 ES Cincel pala
 CN 五坑扁凿



YATO 	L [mm]	
YT-47341	280	10/40

EN Spade chisel
 PL Diuto płaskie
 DE Spatmeißel
 RU Лопатка
 CZ Sekáč plochý
 HU Széles véső

RO Dalta
 FR Burin plat large
 IT Scalpello piatto
 ES Cincel pala
 CN 五坑扁凿





YATO 	L [mm]	
YT-47340	400	10/20

EN Point chisel
 PL Diuto szpiczak
 DE Spitzmeißel
 RU Зубило пиковое
 CZ Špičák
 HU Hegyes véső

RO Dorn
 FR Burin pointu
 IT Scalpello a punta
 ES Cincel punta
 CN 五坑尖凿





YATO 	L [mm]	
YT-47345	280	10/40

EN Point chisel
 PL Diuto szpiczak
 DE Spitzmeißel
 RU Зубило пиковое
 CZ Špičák
 HU Hegyes véső

RO Dorn
 FR Burin pointu
 IT Scalpello a punta
 ES Cincel punta
 CN 五坑尖凿





YATO 	L [mm]	
YT-47344	400	10/20

EN Bushing tool
 PL Groszkownik
 DE Stockerplatte
 RU Отбойные пластины
 CZ Zdršňovací deska
 HU Szemcsészlap

RO Placă de tasare
 FR Boucharde
 IT Bocciarda per martello
 ES Placa de abujardar
 CN 五坑花捶



YATO 	L [mm]	
YT-47348	240	5/10



EN Spade chisel
PL Dłuto szerokie
DE Spatmeißel
RU Широкое долото
CZ Sekáč plochý
HU Széles véső

RO Dalta
FR Burin plat large
IT Scalpello largo
ES Cincel pala
CN 六角扁凿



75x450
mm



YATO 	L [mm]	
YT-47370	450	5/10

EN Spade chisel
PL Dłuto szerokie
DE Spatmeißel
RU Широкое долото
CZ Sekáč plochý
HU Széles véső

RO Dalta
FR Burin plat large
IT Scalpello largo
ES Cincel pala
CN 六角宽凿



125x450
mm



YATO 	L [mm]	
YT-47372	450	5

EN Point chisel
PL Dłuto szpiczak
DE Spitzmeißel
RU Зубило пиковое
CZ Špičák
HU Hegyes véső

RO Dorn
FR Burin pointu
IT Scalpello a punta
ES Cincel punta
CN 五坑尖凿



410
mm



YATO 	L [mm]	
YT-47375	410	5/10

EN Spade chisel
PL Dłuto płaskie
DE Spatmeißel
RU Лопатка
CZ Sekáč plochý
HU Széles véső

RO Dalta
FR Burin plat large
IT Scalpello piatto
ES Cincel pala
CN 五坑扁凿



35x410
mm



YATO 	L [mm]	
YT-47377	410	5/10

EN Point chisel
PL Dłuto samoostrzące
DE Spitzmeißel
RU Зубило пиковое
CZ Špičák
HU Hegyes véső

RO Dorn
FR Burin pointu
IT Scalpello a punta autoaffilante
ES Cincel punta
CN 四刃凿子

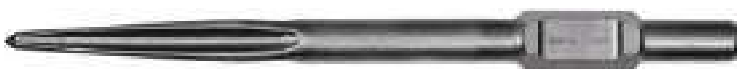

410
mm



YATO 	L [mm]	
YT-47380	410	5/10

EN Adapter
PL Adapter
DE Adapter
RU Адаптер

CZ Adaptér
HU Adapter
RO Adaptor
FR Adaptateur

IT Adattatore
ES Adaptador
CN 五坑转换器



220
mm

SDS
MAX

SDS
PLUS



YATO 	L [mm]	
YT-41926	220	10/30

EN Ground rod chisel
PL Pobijak do uziomów i gwoździ
DE Erdstab-Treiber-Bit
RU Добойник для гвоздей
CZ Zatluokač uzemňovacích tyčí a hřebíků
HU Rudazatbeütő

RO Ciocan bățut buloane cale ferată
FR Enfonceur de piquet de terre
IT Piantapicchetti per piantare chiodi e picchetti
ES Adaptador de varilla de tierra
CN 电镐圆孔凿

∅
20
mm

250
mm

SDS
MAX

CrMo



YATO 	L [mm]	
YT-47195	250	4/24

EN Plate compactor with hex shank
PL Ubijak do gruntu z uchwytem Hex
DE Stampfüsse Hex
RU Трамбовочная пластина
CZ Pěchovací deska Hex
HU Szerszámtartós tömörítőlap Hex

RO Buciardă Hex
FR Plateau de damage Hex
IT Costipatore Hex per la compattazione di terra
ES Placa de apisonar Hex
CN 六角夯锤



150x150
mm



YATO 	L [mm]	
YT-47385	150	2

EN Ground rod chisel
PL Pobijak do uziomów i gwoździ
DE Erdstab-Treiber-Bit
RU Добойник для гвоздей
CZ Zatluokač uzemňovacích tyčí a hřebíků
HU Rudazatbeütő

RO Ciocan bățut buloane cale ferată
FR Enfonceur de piquet de terre
IT Piantapicchetti per piantare chiodi e picchetti
ES Adaptador de varilla de tierra
CN 电镐圆孔凿

∅
25
mm

400
mm



YATO 	L [mm]	
YT-47197	400	4

EN Hollow drill set
PL Wiertło koronowe do betonu
DE Bohrkronen
RU Сверла по бетону корончатые

CZ Korunový vrták na zed
HU Koronafúró falhoz
RO Burghiu cu coroană pt. beton
FR Trépiéd à mur

IT Punta a corona per calcestruzzo
ES Broca widia para muro
CN 扩孔钻

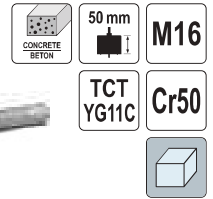

YATO	Ø [mm]	Pilot drill diameter / Średnica wiertła pilota [mm]	
YT-4400	65	6	24
YT-4401	65	8	20

YATO	Ø [mm]	Pilot drill diameter / Średnica wiertła pilota [mm]	
YT-4402	65	6	24
YT-4403	08	8	20

EN Masonry drill bit
PL Wiertło do betonu
DE Betonspiralbohrer
RU Сверло по бетону
CZ Vrták na beton
HU Fúrószer betonhoz
RO Burghiu pt. beton
FR Foret béton
IT Punta per cemento
ES Broca para hormigón
CN 四坑开孔器

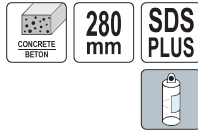

EN Masonry drill bit
PL Wiertło do betonu
DE Betonspiralbohrer
RU Сверло по бетону
CZ Vrták na beton
HU Fúrószer betonhoz

RO Burghiu pt. beton
FR Foret béton
IT Punta per cemento
ES Broca para hormigón
CN 四坑开孔器



YATO	Ø [mm]	L [mm]	
YT-44033	68	280	2/10
YT-44034	82	280	2/6

YATO	Ø [mm]	L [mm]	
YT-44045	55	600	2/8

EN Hole saw
PL Otwornica
DE Lochsäge
RU Универсальная коронка
CZ Vrtací korunka
HU Koronafúró

RO Găurător
FR Scie à trou
IT Sega a tazza
ES Sierra de corona universal
CN TCT开孔器



YATO	Ø [mm]	Thread size / Rozmiar gwintu	
YT-43970	16	1/2" (12.5 mm) 20UNF	6/90
YT-43971	19	1/2" (12.5 mm) 20UNF	6/90
YT-43972	22	1/2" (12.5 mm) 20UNF	6/90
YT-43973	25	1/2" (12.5 mm) 20UNF	6/90
YT-43974	32	5/8" (16.0 mm) 18UNF	6/72
YT-43975	38	5/8" (16.0 mm) 18UNF	6/72

YATO	Ø [mm]	Thread size / Rozmiar gwintu	
YT-43976	51	5/8" (16.0 mm) 18UNF	6/72
YT-43977	60	5/8" (16.0 mm) 18UNF	6/72
YT-43978	64	5/8" (16.0 mm) 18UNF	3/36
YT-43979	68	5/8" (16.0 mm) 18UNF	3/36
YT-43980	76	5/8" (16.0 mm) 18UNF	3/36
YT-43981	83	5/8" (16.0 mm) 18UNF	3/36

YATO	Ø [mm]	Thread size / Rozmiar gwintu	
YT-43982	92	5/8" (16.0 mm) 18UNF	2/36
YT-43983	102	5/8" (16.0 mm) 18UNF	2/36
YT-43984	105	5/8" (16.0 mm) 18UNF	2/36
YT-43985	127	5/8" (16.0 mm) 18UNF	2/20
YT-43986	152	5/8" (16.0 mm) 18UNF	2/20

EN Bi-metal hole saw
PL Otwornica bimetalowa
DE Bimetall-Lochsäge
RU Коронка биметаллическая
CZ Vrtací korunka bimetalová
HU Bi-metál koronafúró
RO Freză bimetalică
FR Scie-trépan bimétal
IT Sega a tazza bimetallica
ES Sierra de corona bimetalica
CN 双金属孔锯



• Application: industry
• To drill holes in stainless steels, cast steels, aluminium, wood, plastics
• Cutting depth: 40 mm

• Przeznaczenie: przemysł
• Do wycinania otworów w stalach nierdzewnych, żeliwie, aluminium, drewnie, tworzywach sztucznych
• Głębokość cięcia: 40 mm

YATO	Ø [mm]	Thread size / Rozmiar gwintu	
YT-3303	19	1/2" (12.5 mm) 20UNF	25/100
YT-3304	20	1/2" (12.5 mm) 20UNF	25/100
YT-3306	22	1/2" (12.5 mm) 20UNF	25/100
YT-3308	25	1/2" (12.5 mm) 20UNF	25/100
YT-3311	29	1/2" (12.5 mm) 20UNF	25/100
YT-3313	32	5/8" (16.0 mm) 18UNF	25/100
YT-3315	35	5/8" (16.0 mm) 18UNF	25/100
YT-3317	38	5/8" (16.0 mm) 18UNF	25/100
YT-3318	40	5/8" (16.0 mm) 18UNF	25/100
YT-3321	44	5/8" (16.0 mm) 18UNF	25/100

YATO	Ø [mm]	Thread size / Rozmiar gwintu	
YT-3322	46	5/8" (16.0 mm) 18UNF	25/100
YT-3323	48	5/8" (16.0 mm) 18UNF	25/100
YT-3324	51	5/8" (16.0 mm) 18UNF	25/100
YT-3327	57	5/8" (16.0 mm) 18UNF	25/50
YT-3329	60	5/8" (16.0 mm) 18UNF	25/50
YT-3330	64	5/8" (16.0 mm) 18UNF	25/50
YT-3332	67	5/8" (16.0 mm) 18UNF	25/50
YT-3333	68	5/8" (16.0 mm) 18UNF	25/50
YT-3334	70	5/8" (16.0 mm) 18UNF	25/50
YT-3336	76	5/8" (16.0 mm) 18UNF	25/50

YATO	Ø [mm]	Thread size / Rozmiar gwintu	
YT-3338	83	5/8" (16.0 mm) 18UNF	25/50
YT-3343	95	5/8" (16.0 mm) 18UNF	25/50
YT-3345	102	5/8" (16.0 mm) 18UNF	10/20
YT-3346	105	5/8" (16.0 mm) 18UNF	10/20
YT-3349	114	5/8" (16.0 mm) 18UNF	10/20
YT-3350	121	5/8" (16.0 mm) 18UNF	10/20
YT-3351	127	5/8" (16.0 mm) 18UNF	10/20
YT-3353	140	5/8" (16.0 mm) 18UNF	10/20

EN TCT hole saw for metal
PL Otwornica TCT do metalu
DE TCT Lochsäge für Metall
RU Кольцевая пила TCT по металлу
CZ Korunkový vrták TCT do kovu
HU TCT körkivágó fémhez

RO Carota TCT pt. metal
FR Scie-trépan TCT pour le métal
IT Sega a tazza TCT per metallo
ES Sierra de corona TCT para metal
CN TCT金属开孔器

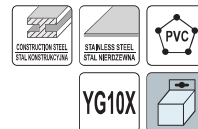

YATO	Ø [mm]	Hex	Box
YT-44050	16	1/4" (6.3 mm)	10/100
YT-44051	18	1/4" (6.3 mm)	10/100
YT-44052	19	1/4" (6.3 mm)	10/100
YT-44053	20	1/4" (6.3 mm)	10/100
YT-44054	22	1/4" (6.3 mm)	10/100
YT-44055	24	1/4" (6.3 mm)	10/100
YT-44056	25	1/4" (6.3 mm)	10/100
YT-44057	29	1/4" (6.3 mm)	10/100
YT-44058	30	1/4" (6.3 mm)	10/100

YATO	Ø [mm]	Hex	Box
YT-44059	32	1/4" (6.3 mm)	10/100
YT-44060	35	1/4" (6.3 mm)	10/100
YT-44061	38	1/4" (6.3 mm)	10/100
YT-44062	40	1/4" (6.3 mm)	10/100
YT-44063	44	3/8" (10.0 mm)	6/60
YT-44064	45	3/8" (10.0 mm)	6/60
YT-44065	50	3/8" (10.0 mm)	6/60
YT-44066	51	3/8" (10.0 mm)	6/60
YT-44067	54	3/8" (10.0 mm)	6/60

YATO	Ø [mm]	Hex	Box
YT-44068	55	3/8" (10.0 mm)	6/60
YT-44069	60	3/8" (10.0 mm)	6/60
YT-44070	65	3/8" (10.0 mm)	6/48
YT-44071	70	3/8" (10.0 mm)	6/48
YT-44072	80	3/8" (10.0 mm)	4/24
YT-44073	90	3/8" (10.0 mm)	4/24
YT-44074	102	3/8" (10.0 mm)	4/24

EN Arbor for hole saw
PL Uchwyt do otwornic
DE Halterung für Lochsägen
RU Держатель универсальных коронок
CZ Šroubový unášec pro vrtací korunky
HU Befogószer a koronafúróhoz

RO Dispozitiv de antrenare pt. găurătorii bimetalici
FR Mandrin aux scies-trépan
IT Alberino per seghe a tazza
ES Adaptador para sierra de corona
CN 孔锯柄轴

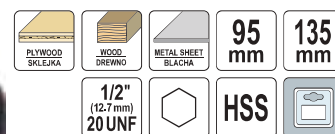

YATO	Ø [mm]	Toolholder type / Rodzaj uchwyty narzędziowego	Thread size / Rozmiar gwintu	Box
YT-43992	6	HEX	1/2" (12.5 mm) 20UNF	20/100

EN Arbor for hole saw
PL Uchwyt do otwornic
DE Halterung für Lochsägen
RU Держатель универсальных коронок
CZ Šroubový unášec pro vrtací korunky
HU Befogószer a koronafúróhoz

RO Dispozitiv de antrenare pt. găurătorii bimetalici
FR Mandrin aux scies-trépan
IT Alberino per seghe a tazza
ES Adaptador para sierra de corona
CN 孔锯柄轴

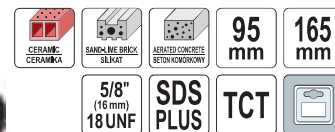

YATO	Ø [mm]	Toolholder type / Rodzaj uchwyty narzędziowego	Thread size / Rozmiar gwintu	Box
YT-43990	8	SDS-Plus	5/8" (16.0 mm) 18UNF	10/90

EN Arbor for hole saw
PL Uchwyt do otwornic
DE Halterung für Lochsägen
RU Держатель универсальных коронок
CZ Šroubový unášec pro vrtací korunky
HU Befogószer a koronafúróhoz

RO Dispozitiv de antrenare pt. găurătorii bimetalici
FR Mandrin aux scies-trépan
IT Alberino per seghe a tazza
ES Adaptador para sierra de corona
CN 孔锯柄轴

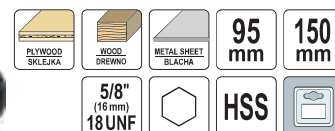

YATO	Ø [mm]	Toolholder type / Rodzaj uchwyty narzędziowego	Thread size / Rozmiar gwintu	Box
YT-43991	6	HEX	5/8" (16.0 mm) 18UNF	10/90

EN Extension bar
PL Przedłużka
DE Verlängerung
RU Удлинитель для воротка
CZ Prodlužovací přípravek
HU Toldalék

RO Prelungitor
FR Rallonge
IT Prolunga
ES Tubo de prolongación
CN 延长接杆



YATO	Toolholder type / Rodzaj uchwyty narzędziowego	H [mm]	Box
YT-43993	sześciokątny, SDS-Plus	300	10/50

EN Pilot drill
PL Wiertło pilot
DE Pilotbohrer
RU Сверло пилот
CZ Středící vrták
HU Központfúró

RO Burghiu pilot
FR Foret - pilot
IT Punta pilota
ES Broca piloto
CN 导向钻



YATO	Ø [mm]	H [mm]	Box
YT-43994	6	95	50/250

EN Pilot drill
PL Wiertło pilot
DE Pilotbohrer
RU Сверло пилот
HU Központfúró

RO Burghiu pilot
FR Foret - pilot
IT Punta pilota
ES Broca piloto
CN 导向钻

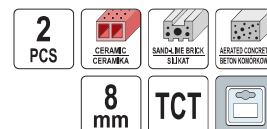

YATO	Ø [mm]	H [mm]	Box
YT-43995	8	95	50/250

EN Arbor for hole saw
 PL Uchwyt do otwornic
 DE Halterung für Lochsägen
 RU Держатель коронок
 CZ Šroubový unášec pro vrtací korunky
 HU Befogószer a koronafúróhoz
 RO Burghiu pt. ghidare freză bimetalică
 FR Mandrin aux scies-trépan
 IT Alberino per seghe a tazza
 ES Adaptador para sierra de corona
 CN 孔锯柄轴

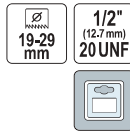

EN Arbor for hole saw
 PL Uchwyt do otwornic
 DE Halterung für Lochsägen
 RU Держатель коронок
 CZ Šroubový unášec pro vrtací korunky
 HU Befogószer a koronafúróhoz
 RO Burghiu pt. ghidare freză bimetalică
 FR Mandrin aux scies-trépan
 IT Alberino per seghe a tazza
 ES Adaptador para sierra de corona
 CN 孔锯柄轴

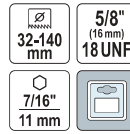

EN Arbor for hole saw
 PL Uchwyt do otwornic
 DE Halterung für Lochsägen
 RU Держатель коронок
 CZ Šroubový unášec pro vrtací korunky
 HU Befogószer a koronafúróhoz
 RO Burghiu pt. ghidare freză bimetalică
 FR Mandrin aux scies-trépan
 IT Alberino per seghe a tazza
 ES Adaptador para sierra de corona
 CN 孔锯柄轴



YATO Toolholder type / Rodzaj uchwytu narzędziowego		
YT-3370	sześciokątny	25/100
YT-3373	SDS-Plus	25/100

YATO Toolholder type / Rodzaj uchwytu narzędziowego		
YT-3371	sześciokątny	25/100

YATO Toolholder type / Rodzaj uchwytu narzędziowego		
YT-3372	sześciokątny	25/50
YT-3374	SDS-Plus	25/50

EN Pilot drill
 PL Wiertło pilot
 DE Pilotbohrer
 RU Сверло пилот

CZ Středící vrták
 HU Központfúró
 RO Burghiu pilot
 FR Foret - pilot

IT Punta pilota
 ES Broca piloto
 CN 导向钻



YATO	Ø [mm]	H [mm]	
YT-3377	6	100	25/100

EN Electrician's hole saw kit
 PL Zestaw otwornic dla elektryków
 DE Lochsägensatz für Elektriker
 RU Набор ножовок к отверстиям для электриков
 CZ Sada vrtacích korunek pro elektrikáře
 HU Koronafúró készlet villanyszerelőknék
 RO Set freze bimetalice
 FR Set de scies trépan aux électriciens
 IT Set universale a tazza fresa con strumenti
 ES Juego de sierras de marquetería para electricistas
 CN 双金属开孔器组套

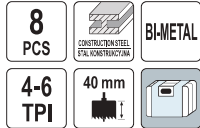

EN Combination hole saw kit
 PL Uniwersalny zestaw otwornic
 DE Universal-Lochsägensatz
 RU Универсальный набор ножовок к отверстиям
 CZ Univerzální sada vrtacích korunek
 HU Univerzális koronafúró készlet
 RO Set freze bimetalice
 FR Set de scies trépan universelles
 IT Set universale a tazza fresa con strumenti
 ES Juego universal de sierras de marquetería
 CN 双金属开孔器组套

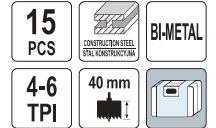

YATO	Ø [mm]	
YT-3380	22, 29, 35, 44, 67, 73	10



YATO	Ø [mm]	
YT-3381	19, 22, 25, 32, 35, 38, 44, 51, 57, 64, 76	5

EN TCT hole saw set
 PL Zestaw otwornic TCT do metalu
 DE TCT Lochsägeset für Metall
 RU Набор кольцевых пил TCT по металлу
 CZ Sada korunkových vrtáků TCT do kovu
 HU TCT körkivágó készlet fémhez
 RO Set carote TCT
 FR Ensemble de scies-trépan TCT pour le métal
 IT Kit di seghe a tazza TCT per metallo
 ES Juego de sierras de corona TCT para metal
 CN TCT金属开孔器组套



YATO	Ø [mm]	
YT-44077	22, 30, 35, 45, 50, 65	1/4" (6.3 mm), 3/8" (10.0 mm) 12

EN Combined drill tap
PL Wiertło-gwintownik
DE Gewindebohrer Bit
RU Сверло метчик
CZ Bitový kombinovaný závitník
HU Fúró-menetfúró bit befogású

RO Burghiu tarod Hex
FR Fraise à tarauds combinés
IT Punte madreviti
ES Broca roscadora Hex
CN 六角柄复合丝锥

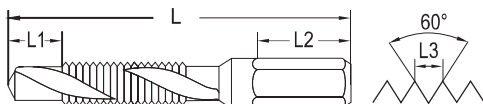

YATO	Size / Rozmiar	L [mm]	L1 [mm]	L2 [mm]	L3 [mm]	
YT-44840	M3	36	5	14	0.5	20/200
YT-44841	M4	39	6	14	0.7	20/200
YT-44842	M5	41	7	14	0.8	20/200
YT-44843	M6	44	8	14	1.0	20/200
YT-44845	M8	51	11	14	1.3	20/200
YT-44847	M10	59	15	14	1.5	20/200

EN Combined drill taps hex set
PL Zestaw wiertło-gwintowników Hex
DE Gewindebohrer Bit Satz
RU Набор сверл метчиков Hex
CZ Sada bitový kombinovaný závitník
HU Fúró-menetfúró bit befogású
RO Set burghiu tarod
FR Kit de mèches fraise à tarauds combinés
IT Set di punte madreviti esagonali
ES Juego de brocas roscadoras
CN 六角柄复合丝锥组套



1/4" (6.3 mm)

YATO	Size / Rozmiar	
YT-44849	M3, M4, M5, M6, M8, M10	5/60

EN Hand tap
PL Gwintownik ręczny
DE Handgewindebohrer
RU Ручной метчик
CZ Závitník
HU Menetfúró

RO Tarozii
FR Taraud à main
IT Maschi filettatura a mano
ES Machos de rosca
CN 三件套手用丝锥

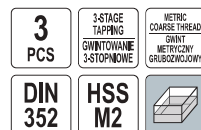

YATO	Size / Rozmiar	Thread pitch / Skok gwintu [mm]	Thread length / Długość gwintu [mm]	L [mm]	Shank diameter / Średnica trzonu [mm]	pcs / szt.	m [g]
YT-2930	M3	0.5	11	40	3.5	3	25
YT-2931	M4	0.7	13	45	4.5	3	35
YT-2932	M5	0.8	16	50	6.0	3	45
YT-2933	M6	1.0	19	50	6.0	3	45
YT-2934	M7	1.0	19	50	6.0	3	55
YT-2935	M8	1.3	22	56	6.0	3	60
YT-2937	M10	1.5	24	70	7.0	3	85
YT-2939	M12	1.8	29	75	9.0	3	125
YT-2940	M14	2.0	30	80	10.5	3	200
YT-2941	M16	2.0	32	80	11.0	3	235
YT-2942	M18	2.5	40	95	12.0	3	345
YT-2943	M20	2.5	40	95	14.0	3	445

EN Machine tap
PL Gwintownik maszynowy
DE Maschinengewindebohrer
RU Машинный метчик
CZ Strojní závitník
HU Gépi menetfúró

RO Tarod de maşină
FR Taraud machine
IT Maschi filettatura
ES Macho mecanico
CN 机用丝锥

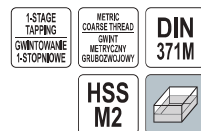
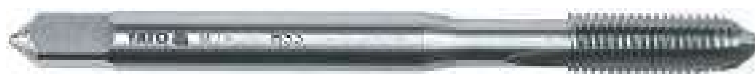

YATO	Size / Rozmiar	Thread pitch / Skok gwintu [mm]	Thread length / Długość gwintu [mm]	L [mm]	Shank diameter / Średnica trzonu [mm]	m [g]
YT-2950	M3	0.5	11	56	3.5	15
YT-2951	M4	0.7	13	63	4.5	20
YT-2952	M5	0.8	16	70	6.0	25
YT-2953	M6	1.0	19	80	6.0	30
YT-2954	M7	1.0	19	80	7.1	35
YT-2955	M8	1.3	22	90	8.0	45
YT-2956	M10	1.5	24	100	10.0	65

EN Machine tap
PL Gwintownik maszynowy
DE Maschinengewindebohrer
RU Машинный метчик
CZ Strojní závitník
HU Gépi menetfúró

RO Tarod de maşină
FR Taraud machine
IT Maschi filettatura
ES Macho mecanico
CN 机用丝锥

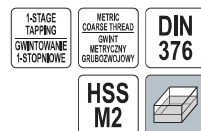

YATO	Size / Rozmiar	Thread pitch / Skok gwintu [mm]	Thread length / Długość gwintu [mm]	L [mm]	Shank diameter / Średnica trzonu [mm]	m [g]
YT-2944	M12	1.8	29	110	9	70
YT-2945	M14	2.0	30	110	11	110
YT-2946	M16	2.0	32	110	12	120

EN Tap and die set
 PL Zestaw narzynek i gwintowników
 DE Gewindeschneidwerkzeug-Satz
 RU Набор плашек и метчиков
 CZ Souprava závitníků a kruhových závitových čelistí
 HU Menetfűrös és menetvágó készlet
 RO Set de tarozi și filiere
 FR Set de filières et tarauds
 IT Set di filiera a maschi
 ES Juego de machosde roscar y cojinetes
 CN 丝锥板牙组套

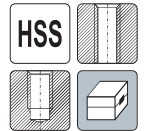

32
PCS

DIN
223
352

YATO	Size / Rozmiar	
YT-2975	M3, M4, M5, M6, M8, M10, M12	10



56
PCS

DIN
223
225
352
DIN1814

44
PCS

DIN
223
225
338
352
DIN1814



YATO	Size / Rozmiar	
YT-2978	M3, M4, M5, M6, M8, M10, M12	4

YATO	Size / Rozmiar	
YT-2979	M3, M4, M5, M6, M8, M10, M12, M14, M16, M18, M20	2

10

EN Tap set
 PL Zestaw gwintowników
 DE Gewindeschneidwerkzeug-Satz
 RU Набор метчиков
 CZ Souprava závitníků
 HU Menetfűrös készlet
 RO Set de tarozi
 FR Set de tarauds
 IT Set di filettatura
 ES Juego de machos de roscar
 CN 公制丝锥组套



29
PCS

DIN
338
352
1814



21
PCS

DIN
352

YATO	Size / Rozmiar	
YT-2976	M3, M4, M5, M6, M8, M10, M12	20

YATO	Size / Rozmiar	
YT-2977	M3, M4, M5, M6, M8, M10, M12	12

EN Circular die
 PL Narzynka
 DE Schneideisen
 RU Пнаука
 CZ Kruhová závitová čelist
 HU Menetvágó
 RO Filieră
 FR Filière
 IT Filiere tonde filettatura
 ES Cojnete de roscar
 CN 圆板牙



YATO	Size / Rozmiar	Thread pitch / Skok gwintu [mm]	External diameter / Średnica zewnętrzna [mm]	Thickness / Grubość [mm]	m [g]	
YT-2961	M4	0.7	20	5	20	125/500
YT-2962	M5	0.8	20	7	20	100/400
YT-2963	M6	1.0	20	7	20	100/400
YT-2964	M7	1.0	25	9	35	100/200
YT-2965	M8	1.3	25	9	35	100/400
YT-2967	M10	1.5	30	11	50	70/280
YT-2969	M12	1.8	38	14	90	60/240
YT-2970	M14	2.0	38	14	95	63/252
YT-2971	M16	2.0	45	18	160	50/200
YT-2973	M20	2.5	45	18	150	50/200
YT-2966	M24	3.0	55	22	300	20/80

EN Step drill
PL Wiertło stopniowe
DE Stufenbohrer
RU Сверло ступенчатое
CZ Stupňovitý vrták
HU Lépcsős fúró

RO Burghiu in trepte
FR Foret étagé
IT Punta a gradini
ES Broca cónica escalonada
CN 阶梯钻



HSS
4241

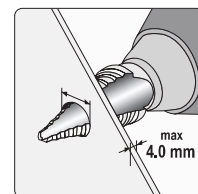

YATO	Steps quantity / Liczba stopni	Ø [mm]	L [mm]	Working length / Długość robocza [mm]	
YT-44743	7	14, 16, 18, 20, 22, 24, 26	70	40	100
YT-44742	8	10, 15, 20, 25, 30, 35, 40, 45	100	75	40
YT-44741	10	4, 6, 8, 10, 12, 14, 16, 18, 20, 22	75	52	25/50
YT-44739	10	6, 10, 13, 16, 19, 22, 25, 29, 32, 35	75	45	10/60
YT-44744	10	6, 12, 13, 14, 15, 16, 17, 18, 19, 20	75	55	20/200
YT-44745	11	10, 11, 12, 13, 14, 15, 16, 17, 18, 19, 20	75	52	20/200
YT-44747	11	20, 21, 22, 23, 24, 25, 26, 27, 28, 29, 30	75	54	12/96
YT-44746	12	10, 20, 21, 22, 23, 24, 25, 26, 27, 28, 29, 30	87	60	12/96
YT-44740	12	6, 8, 11, 14, 17, 20, 23, 26, 29, 32, 35, 38	105	78	10/60

EN Step drill set
PL Zestaw wiertel stopniowych
DE Stufenbohrer Set
RU Набор ступенчатых сверл
CZ Sada stupňovitých vrtáků
HU Lépcsős fúró készlet
RO Set burghie in trepte
FR Jeu de forets étagés
IT Set di punte a gradino
ES Juego de brocas cónicas escalonadas
CN 阶梯钻组套

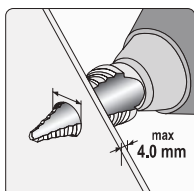

YATO	Ø [mm]	
YT-44731	3-12 (3, 4, 5, 6, 7, 8, 9, 10, 11, 12 mm), 4-12 (4, 6, 8, 10, 12 mm), 4-20 (4, 6, 8, 10, 12, 14, 16, 18, 20 mm)	40

EN Step drill set
PL Zestaw wiertel stopniowych
DE Stufenbohrer Set
RU Набор ступенчатых сверл
CZ Sada stupňovitých vrtáků
HU Lépcsős fúró készlet
RO Set burghie in trepte
FR Jeu de forets étagés
IT Set di punte a gradino
ES Juego de brocas cónicas escalonadas
CN 阶梯钻组套

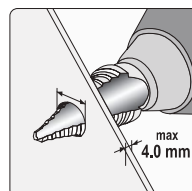

YATO	Ø [mm]	
YT-44732	4-12 (4, 6, 8, 10, 12 mm), 4-22 (4, 6, 8, 10, 12, 14, 16, 18, 20, 22 mm), 6-38 (6, 8, 11, 14, 17, 20, 23, 26, 29, 32, 35, 38 mm)	6/24

EN Taper drill set
PL Zestaw wiertel stożkowych
DE Blechschräbbohrer-Satz
RU Набор ступенчатых сверл
CZ Sada kuželových vrtáků do plechu
HU Rézszes lemezfúró készlet
RO Set alezoare in trepte
FR Set de perceuse taper
IT Set di punte coniche
ES Conjunto brocas cónicas
CN 薄板钻

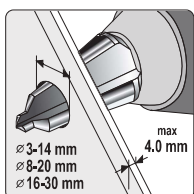
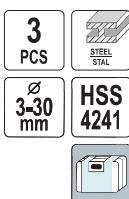

YATO	Ø [mm]	
YT-44730	3-14, 8-20, 16-30	10/30

EN Countersink
PL Pogłębiacz
DE Kegelsenker
RU Конусный зенкер
CZ Kuželový záhlubník
HU Kúpos sülyesztő

RO Zencuitor
FR Fraise conique
IT Accocatoio
ES Avellanador cónico
CN 倒角器

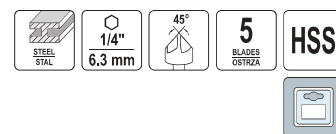

YATO	Ø [mm]	L [mm]	
YT-44721	6.3	40	50/200
YT-44722	8.3	40	50/200
YT-44723	10.4	40	50/200
YT-44724	12.4	40	50/200
YT-44725	16.5	45	25/100
YT-44726	20.5	45	25/100

- EN Countersink set
- PL Zestaw pogłębiaczy do metalu
- DE Kegelsenker-Satz
- RU Конусный зенкер
- CZ Kuželový záhlubník
- HU Kúpos süllyeszítő
- RO Zencuitor
- FR Fraise conique
- IT Set di svasatori per metallo
- ES Avellanador cónico
- CN 倒角器组套



6 PCS

1/4" **6.3 mm**

5 BLADES **HSS**

- EN T-handle tap wrench
- PL Pokrętko typu „T” do gwintowników
- DE Gewinde-Werkzeughalter
- RU Рукотка типа „Т” к гаечному ключу
- CZ Vratidlo na závitníky typ „T”
- HU Menetfűró befogó T-nyelű
- RO Port tarod cu maner
- FR Porte-taroud type „T”
- IT Chiave giramaschio tipo „T” per maschi
- ES Llave giramachos „T”
- CN 丝锥扳手



YATO	Size / Rozmiar	L [mm]	
YT-2986	M3-M8	70	20/80
YT-2987	M5-M10	80	20/80
YT-2988	M6-M12	90	20/80

YATO	Ø [mm]	
YT-44729	6.3, 8.3, 10.4, 12.4, 16.5, 20.5	20

- EN Ratchet tap wrench
- PL Grzechotka do gwintownika
- DE Gewinde-Werkzeughalter
- RU Трещетка для метчика
- CZ Ráčnové vratidlo pro závitníky
- HU Racsnis hajtószer menetfűróhoz
- RO Port tarod
- FR Porte-taroud à cliquet
- IT Chiave giramaschi a cricchetto
- ES Carraca para macho de roscar
- CN 棘轮丝锥扳手



YATO	Size / Rozmiar	L [mm]	
YT-2989	M3-M10	85	20/80
YT-2997	M3-M10	250	20/80
YT-2990	M5-M12	100	20/80
YT-2991	M5-M12	300	20/40

- EN Die handle
- PL Oprawa do narzynek
- DE Schneisenhalter
- RU Плашкодержатель
- CZ Závitová objímka
- HU Menetvágó tartó
- RO Portfilieră
- FR Porte-filière
- IT Porta filiere
- ES Portacoinjete
- CN 板牙扳手

DIN 225



YATO	Size / Rozmiar	External diameter / Średnica zewnętrzna [mm]	Thickness / Grubość [mm]	L [mm]	
YT-2980	M3-M4	20	5	200	25/100
YT-2981	M4.5-M6	20	7	200	25/100
YT-2982	M7-M9	25	9	224	25/100
YT-2983	M10-M11	30	11	280	25/50
YT-2984	M12-M14	38	14	315	15/30
YT-2985	M16-M20	45	18	450	10/20

- EN Tap wrench
- PL Pokrętko do gwintowników
- DE Gewinde-Werkzeughalter
- RU Вороток для метчиков
- CZ Ovládací kolečko na závitník
- HU Hajtószer menetfűróhoz
- RO Cheie (măner) pt. tarod
- FR Porte-taroud
- IT Manopola per il maschio
- ES Llave giramachos
- CN 一型丝锥扳手

DIN 1814



YATO	Size / Rozmiar	L [mm]	
YT-2995	M1-M8	125	50/200
YT-2996	M3-M10	180	25/100
YT-2992	M3-M12	200	25/100
YT-2993	M4-M12	280	25/100
YT-2994	M5-M20	375	20/40

- EN Plug & forstener cutter
- PL Flekownik-sękwownik do drewna
- DE Zapfenschneider und Forstnerbohrer für Holz
- RU Сверла по дереву: коронка и фреза
- CZ Kotoučových vykrajovačů-sukovníků do dřeva
- HU Csapmaró-fűró szerszámkészlet fához
- RO Set burghie reparat lemn
- FR Ensemble pour réparation des nœuds dans le bois
- IT Punta forstner per legno
- ES Broca fresadora para madera
- CN 木塞钻和平翼钻组套

2 PCS

HRC 45-48

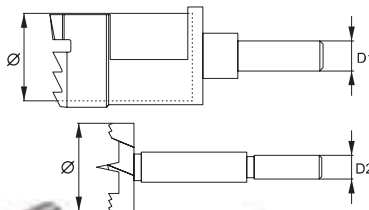

YATO	Ø [mm]	D1 [mm]	D2 [mm]	
YT-33830	15	10	8	10/100
YT-33831	20	12	8	10/100
YT-33832	25	12	8	10/100
YT-33833	30	12	8	10/60
YT-33834	35	12	10	10/60

- EN Plug & forstener cutter set
- PL Zestaw flekowników-sękwowników do drewna
- DE Zapfenschneider und Forstnerbohrer-Set für Holz
- RU Набор сверл по дереву: коронки и фрезы
- CZ Sada kotoučových vykrajovačů-sukovníků do dřeva
- HU Csapmaró-fűró szerszámkészlet fához
- RO Set burghie reparat lemn
- FR Ensemble pour réparation des nœuds dans le bois
- IT Set di punta forstner per legno
- ES Juego de brocas fresadoras para madera
- CN 木塞钻和平翼钻组套

10 PCS

8,10 mm

10,12 mm

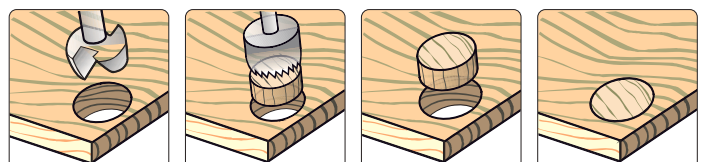

YATO	Ø [mm]	
YT-33837	15, 20, 25, 30, 35	20

EN Rotary file
PL Tarnik trzpieniowy
DE Profil-Fräser
RU Набор фасонных фрез
CZ Hrotové rašple
HU Fareszelőkészlet, csapszárás
RO Raspeluri cu coadă
FR Fichiers rotary
IT Fresa a gradino per metallo
ES Arquivos rotary
CN 旋转锉

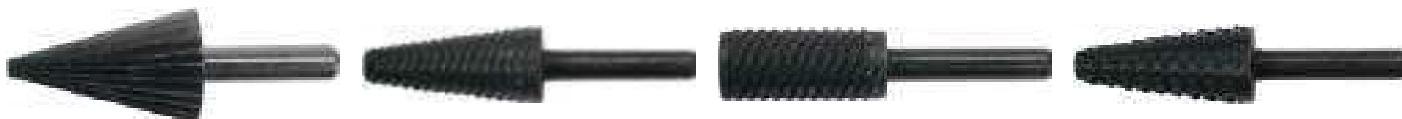

YATO	Ø [mm]	
YT-61700	4-24	10/120



YATO	Ø [mm]	
YT-61701	6-15	10/120

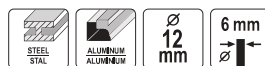

YATO	Ø [mm]	
YT-61702	12	10/120



YATO	Ø [mm]	
YT-61703	6-15	10/120



YATO	Ø [mm]	
YT-61704	13	10/120



YATO	Ø [mm]	
YT-61705	15	10/120



YATO	Ø [mm]	
YT-61706	20	10/120



YATO	Ø [mm]	
YT-61707	25	10/120

EN Rotary file for metal
PL Frez trzpieniowy do metalu
DE Schaffräser für Metall
RU Концевая фреза по металлу
CZ Stopková fréza na kov
HU Végmaró fémhez
RO Freza pt. metal
FR Fraise en bout pour le métal
IT Fresa a candela per metallo
ES Fresa de extremo para metal
CN 硬质合金旋转锉

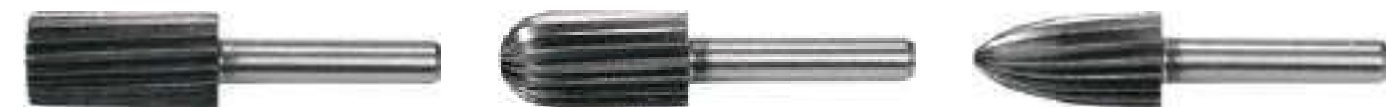
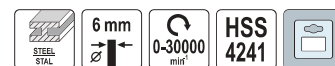

YATO	Ø [mm]	
YT-61714	13	80



YATO	Ø [mm]	
YT-61715	13	80



YATO	Ø [mm]	
YT-61716	13	80



YATO	Ø [mm]	
YT-61717	13	80



YATO	Ø [mm]	
YT-61718	13	80



YATO	Ø [mm]	
YT-61719	6	80

EN Rotary file set
PL Tarniki trzpieniowe
DE Profil-Fräser Satz
RU Набор фрез
CZ Hrotové rašple
HU Fareszelőkészlet, csapszárás
RO Raspeluri cu coadă
FR Ensemble de fichiers rotary
IT Set di frese
ES Rotatorio archivos
CN 旋转锉

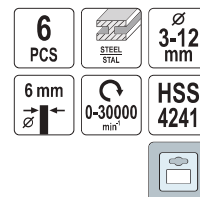

YATO	Ø [mm]	
YT-61711	3-15	12/48

EN Rotary file for metal
 PL Frez trzpieniowy do metalu
 DE Schaftfräser für Metall
 RU Концевая фреза по металлу
 CZ Stopková fréza na kov
 HU Végmaró fémezhez
 RO Freza pt. metal
 FR Fraise en bout pour le métal
 IT Fresa a candela per metallo
 ES Fresa de extremo para metal
 CN 硬质合金旋转锉



56 mm



YATO	Ø [mm]	
YT-61722	10	40/80

56 mm



YATO	Ø [mm]	
YT-61723	10	40/80

58 mm



YATO	Ø [mm]	
YT-61724	10	40/80

45 mm

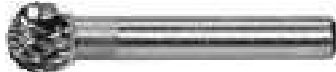

YATO	Ø [mm]	
YT-61725	10	40/80

58 mm



YATO	Ø [mm]	
YT-61726	10	40/80

50 mm



YATO	Ø [mm]	
YT-61727	10	40/80

EN Rotary file set for metal premium
 PL Zestaw frezów trzpieniowych do metalu premium
 DE Schaftfräser für metall Premium
 RU Концевые фрезы по металлу премиум
 CZ Stopkové frézy do kovu premium
 HU Marószárak fémezhez prémium
 RO Set freze metal
 FR Fraises à mandrin pour métal premium
 IT Set di frese con codolo per metalli premium
 ES Fresas para metal premium
 CN 硬质合金旋转锉

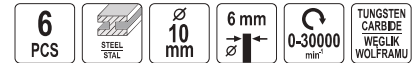

YATO	Ø [mm]	L [mm]	
YT-61729	10	45, 50, 56, 56, 58, 58	20/40

EN Rotary file set
 PL Tarniki trzpieniowe
 DE Profil-Fräser Satz
 RU Набор фрез
 CZ Hrotové rašple
 HU Fareszelőkészlet, csapszárás
 RO Raşpeluri cu coadă
 FR Ensemble de fichiers rotatifs
 IT Set di frese
 ES Rotatorio archivos
 CN 旋转锉

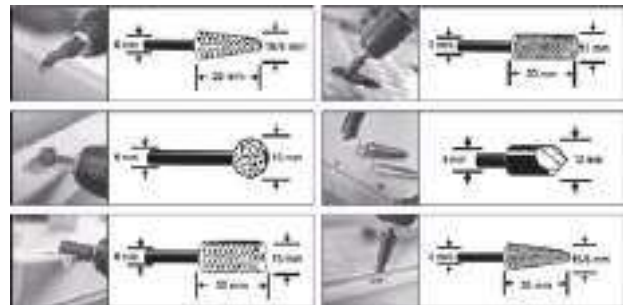

YATO	Ø [mm]	
YT-61712	6-15	10/60

EN Forstner drill bit
 PL Wiertło do drewna pod zawiasy
 DE Forstnerbohrer
 RU Сверло форстнера по дереву
 CZ Karbidový vrták na vrtání otvorů pro závěsy
 HU Forstner fúrószár fához
 RO Freza pt. lemn
 FR Mèche de perceuse à bois
 IT Punta per legno per cerniere
 ES Broca para bisagras
 CN 木工开孔器



YATO	Ø [mm]	
YT-33010	26	10/100
YT-33011	35	10/100

EN Forstner drill bit set
 PL Zestaw wiertel do drewna pod zawiasy
 DE Forstnerbohrer Set
 RU Набор сверел форстнера по дереву
 CZ Sada karbidový vrták na vrtání otvorů pro závěsy
 HU Forstner fúrószár készlet fához
 RO Set freze pt. lemn
 FR Mèches de perceuse à bois
 IT Set di punte per legno per cerniere
 ES Juego de brocas para bisagras
 CN 木工开孔器组套



YATO	Ø [mm]	
YT-33015	15, 20, 26, 30, 35	20

EN Router bit set
PL Zestaw frezów do drewna
DE Oberfrärsersatz
RU Набор фрез по дереву

CZ Souprava frézů do dřeva
HU Medtjő frezj komplextas
RO Set de freze pt. lemn
FR Fraises pour le bois

IT Set di frese per legno
ES Juego de frezas para madera
CN 木工铣刀组套



Router bit parameter												
shank diameter / średnica uchwyty (mm)	6.0	6.0	6.0	6.0	6.0	6.0	6.0	6.0	6.0	6.0	6.0	6.0
length / długość (mm)	51.0	49.0	51.0	45.0	48.0	48	50.0	53.0	50.0	52.0	38.0	39.0
router bit diameter / średnica frezu (mm)	6.0	12.0	16.0	12.7	32.0	22.0	25.4	28.6	22.0	12.7	13.0	12.7
cutting edge length / długość krawędzi tnącej (mm)	20.0	20.0	20.0	12.7	12.7	10.5	11.5	16.0	12.0	13.0	9.5	6.35
curvature radius / promień krzywizny (mm)	-	-	-	-	-	12.7	3.175	9.5	6.35	-	-	-
bearing diameter / średnica łożyska (mm)	-	-	-	-	9.0	9.0	9.0	9.0	9.0	9.0	-	-
angle / kąt (°)	-	-	-	10.0	45.0	-	-	-	-	-	90.0	-



YATO
YT-68006

20

EN Router bit set
PL Zestaw frezów do drewna
DE Oberfrärsersatz
RU Набор фрез по дереву

CZ Souprava frézů do dřeva
HU Medtjő frezj komplextas
RO Set de freze pt. lemn
FR Fraises pour le bois

IT Set di frese per legno
ES Juego de frezas para madera
CN 木工铣刀组套

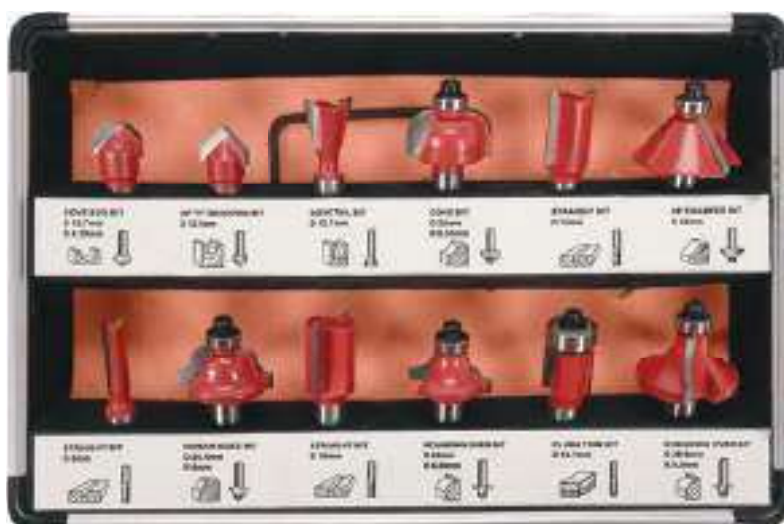

Router bit parameter												
shank diameter / średnica uchwyty (mm)	8.0	8.0	8.0	8.0	8.0	8.0	8.0	8.0	8.0	8.0	8.0	8.0
length / długość (mm)	51.0	49.0	51.0	45.0	48.0	48	50.0	53.0	50.0	52.0	38.0	39.0
router bit diameter / średnica frezu (mm)	6.0	12.0	16.0	12.7	32.0	22.0	25.4	28.6	22.0	12.7	13.0	12.7
cutting edge length / długość krawędzi tnącej (mm)	20.0	20.0	20.0	12.7	12.7	10.5	11.5	16.0	12.0	13.0	9.5	6.35
curvature radius / promień krzywizny (mm)	-	-	-	-	-	12.7	3.175	9.5	6.35	-	-	-
bearing diameter / średnica łożyska (mm)	-	-	-	-	9.0	9.0	9.0	9.0	9.0	9.0	-	-
angle / kąt (°)	-	-	-	10.0	45.0	-	-	-	-	-	90.0	-



YATO
YT-68005

20

EN Router bit set CZ Souprava frézů do dřeva IT Set di frese per legno
 PL Zestaw frezów do drewna HU Medtjio frezř kompletas ES Juego de frezas para madera
 DE Oberfrärsersatz RO Set de freze pt. lemn CN 木工铣刀组套
 RU Набор фрез по дереву FR Fraises pour le bois

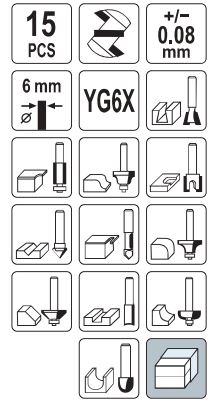

Router bit parameter															
shank diameter / średnica uchwyty [mm]	6.0	6.0	6.0	6.0	6.0	6.0	6.0	6.0	6.0	6.0	6.0	6.0	6.0	6.0	6.0
length / długość [mm]	43.0	49.0	51.0	45.0	48.0	51.0	50.0	53.0	50.0	52.0	38.0	39.0	49.0	60.0	43.0
router bit diameter / średnica frezu [mm]	12.7	12.0	16.0	12.7	32.0	6.0	25.4	28.6	22.0	12.7	12.7	9.5	6.35	3.0	6.35
cutting edge length / długość krawędzi tnącej [mm]	12.7	20.0	20.0	12.7	12.7	20.0	11.5	16.0	12.0	13.0	9.5	6.35	13.0	19.50	6.0
curvature radius / promień krzywizny [mm]	-	-	-	-	-	-	3.175	9.5	6.35	-	-	-	-	-	3.2
bearing diameter / średnica łożyska [mm]	-	-	-	-	9.0	-	9.0	9.0	9.0	9.0	-	-	-	-	-
angle / kąt [°]	-	-	-	10.0	45.0	-	-	-	-	-	90	-	-	-	-



YATO
 YT-68007 20

EN Router bit set CZ Souprava frézů do dřeva IT Set di frese per legno
 PL Zestaw frezów do drewna HU Medtjio frezř kompletas ES Juego de frezas para madera
 DE Oberfrärsersatz RO Set de freze pt. lemn CN 木工铣刀组套
 RU Набор фрез по дереву FR Fraises pour le bois

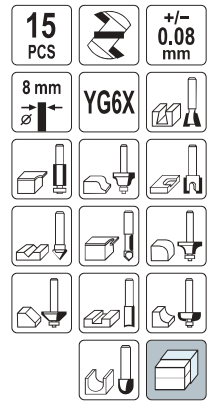
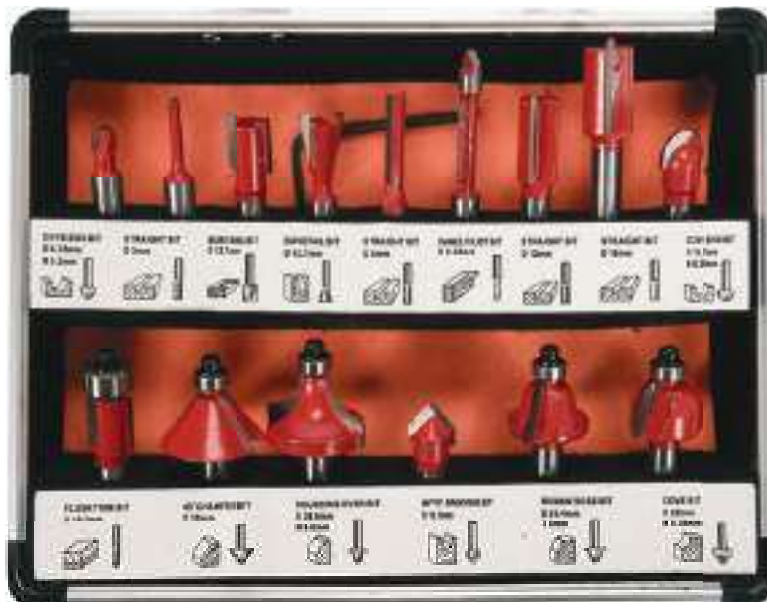

Router bit parameter															
shank diameter / średnica uchwyty [mm]	8.0	8.0	8.0	8.0	8.0	8.0	8.0	8.0	8.0	8.0	8.0	8.0	8.0	8.0	8.0
length / długość [mm]	43.0	49.0	51.0	45.0	48.0	51.0	50.0	53.0	50.0	52.0	38.0	39.0	49.0	60.0	43.0
router bit diameter / średnica frezu [mm]	12.7	12.0	16.0	12.7	32.0	6.0	25.4	28.6	22.0	12.7	12.7	9.5	6.35	3.0	6.35
cutting edge length / długość krawędzi tnącej [mm]	12.7	20.0	20.0	12.7	12.7	20.0	11.5	16.0	12.0	13.0	9.5	6.35	13.0	19.50	6.0
curvature radius / promień krzywizny [mm]	-	-	-	-	-	-	3.175	9.5	6.35	-	-	-	-	-	3.2
bearing diameter / średnica łożyska [mm]	-	-	-	-	9.0	-	9.0	9.0	9.0	9.0	-	-	-	-	-
angle / kąt [°]	-	-	-	10.0	45.0	-	-	-	-	-	90	-	-	-	-



YATO
 YT-68002 20

10

EN Diamond blade
 PL Tarcza diamentowa
 DE Diamant-Trennscheibe
 RU Отрезной алмазный диск
 CZ Diamantový kotouč
 HU Gyémántkorong
 RO Disc cu diamant
 FR Disque diamant
 IT Disco diamantato
 ES Disco de diamante
 CN 金刚石切片

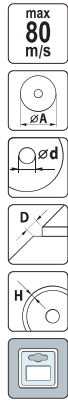

EN Diamond blade
 PL Tarcza diamentowa
 DE Diamant-Trennscheibe
 RU Отрезной алмазный диск
 CZ Diamantový kotouč
 HU Gyémántkorong
 RO Disc cu diamant
 FR Disque diamant
 IT Disco diamantato
 ES Disco de diamante
 CN 热压湿片

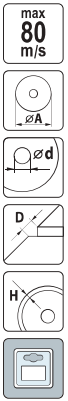

• Application: concrete, brick, tile, masonry, stone, sandstone, refractory materials, limestone

• Przeznaczenie: beton utwardzony, cegła, granit, mur, kamień, piaskowiec, materiały ogniotrwałe, siliakty

• Application: ceramic, glaze

• Przeznaczenie: płytki ceramiczne, glazura, płytki kamienne

YATO	ØA [mm]	Ød [mm]	max C [min ⁻¹]	D [mm]	H [mm]	
YT-59961	115	22.2	12000	1.8	10	20/200
YT-59962	125	22.2	12000	2.0	10	20/100
YT-59965	230	22.2	6500	2.2	10	25
YT-60003	350	25.4	4400	3.4	10	10
YT-60004	400	25.4	3850	3.6	10	5

YATO	ØA [mm]	Ød [mm]	max C [min ⁻¹]	D [mm]	H [mm]	
YT-59951	115	22.2	12000	1.6	10	20/200
YT-59952	125	22.2	12000	1.6	10	20/100
YT-59955	230	22.2	6500	2.2	10	25

EN Diamond blade
 PL Tarcza diamentowa
 DE Diamant-Trennscheibe
 RU Отрезной алмазный диск
 CZ Diamantový kotouč
 HU Gyémántkorong
 RO Disc cu diamant
 FR Disque diamant
 IT Disco diamantato
 ES Disco de diamante
 CN 热压X形金刚石锯片

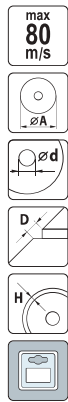

EN Diamond blade
 PL Tarcza diamentowa
 DE Diamant-Trennscheibe
 RU Отрезной алмазный диск
 CZ Diamantový kotouč
 HU Gyémántkorong
 RO Disc cu diamant
 FR Disque diamant
 IT Disco diamantato
 ES Disco de diamante
 CN 热压超薄波纹片

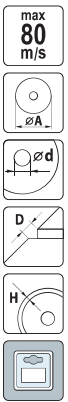

• Application: ceramic, glaze, glass, porcelain, ceramic tiles, composite hardest tiles, roof tiles

• Przeznaczenie: płytki ceramiczne, glazura, płytki kamienne, szkło, porcelana, ceramika, gres, dachówki

• Application: reinforced concrete, glaze, clinker, brick, limestone

• Przeznaczenie: beton zbrojony, granit, klinkier, siliakty

YATO	ØA [mm]	Ød [mm]	max C [min ⁻¹]	D [mm]	H [mm]	
YT-59971	115	22.2	12000	1.6	10	20/120
YT-59972	125	22.2	12000	1.6	10	20/100
YT-59975	230	22.2	6500	2.0	10	25

YATO	ØA [mm]	Ød [mm]	max C [min ⁻¹]	D [mm]	H [mm]	
YT-59981	115	22.2	12000	1.3	10	20/200
YT-59982	125	22.2	12000	1.3	10	20/100
YT-59985	230	22.2	6500	2.0	10	25

EN Diamond blade
 PL Tarcza diamentowa
 DE Diamant-Trennscheibe
 RU Отрезной алмазный диск
 CZ Diamantový kotouč
 HU Gyémántkorong

RO Disc cu diamant
 FR Disque diamant
 IT Disco diamantato
 ES Disco de diamante
 CN 金刚石切片

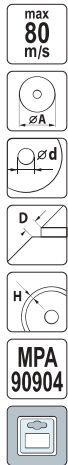

EN Diamond blade
 PL Tarcza diamentowa
 DE Diamant-Trennscheibe
 RU Отрезной алмазный диск
 CZ Diamantový kotouč
 HU Gyémántkorong

RO Disc cu diamant
 FR Disque diamant
 IT Disco diamantato
 ES Disco de diamante
 CN 金刚石切片

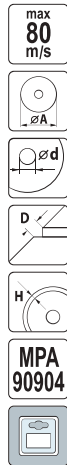

EN Diamond blade
 PL Tarcza diamentowa
 DE Diamant-Trennscheibe
 RU Отрезной алмазный диск
 CZ Diamantový kotouč
 HU Gyémántkorong

RO Disc cu diamant
 FR Disque diamant
 IT Disco diamantato
 ES Disco de diamante
 CN 金刚石切片



• Application: concrete, brick, calcium-silicate brick, tile, masonry, stone

• Przeznaczenie: beton utwardzony, cegła, cegła siliakata, granit, mur, kamień

• Application: ceramic, gres, glaze, glass, porcelain

• Przeznaczenie: płytki ceramiczne, gres, glazura, płytki kamienne, szkło, porcelana

• Application: concrete, reinforced concrete, brick, tile, masonry, stone, sandstone

• Przeznaczenie: beton utwardzony, beton zbrojony, cegła, granit, mur, kamień, piaskowiec

YATO	ØA [mm]	Ød [mm]	max C [min ⁻¹]	D [mm]	H [mm]	
YT-6002	115	22.2	12000	2.1	8	20/200
YT-6003	125	22.2	11000	2.2	8	20/160
YT-6004	180	22.2	8000	2.5	8	15/60
YT-6005	230	22.2	6500	2.7	8	10/40

YATO	ØA [mm]	Ød [mm]	max C [min ⁻¹]	D [mm]	H [mm]	
YT-6012	115	22.2	12000	2.1	5.3	20/200
YT-6013	125	22.2	11000	2.2	5.3	20/160
YT-6014	180	22.2	8000	2.5	5.3	15/60
YT-6015	230	22.2	6500	2.7	5.3	10/40
YT-6016	180	25.4	8000	2.2	5.3	15/60
YT-6017	200	25.4	8000	2.2	5.3	10/40

YATO	ØA [mm]	Ød [mm]	max C [min ⁻¹]	D [mm]	H [mm]	
YT-6022	115	22.2	12000	2.4	8	20/200
YT-6023	125	22.2	11000	2.6	8	20/160
YT-6024	180	22.2	8000	2.8	8	15/60
YT-6025	230	22.2	6500	3.1	8	10/40

- EN Diamond polishing disc for stoneware
PL Tarcza diamentowa do szlifowania gresu
DE Diamant-Schleifpad für Steinzeug
RU Алмазный диск для шлифования керамогранита
CZ Kotouč leštící diamentový na keramiku
HU Gyémánt csiszoló polírozó korong
RO Disc diamentat pt. gresie
FR Disque de polissage diamant pour grès
IT Disco lucidante diamantato per piastrelle
ES Disco de diamante para pulir gres
CN 金刚石软磨片

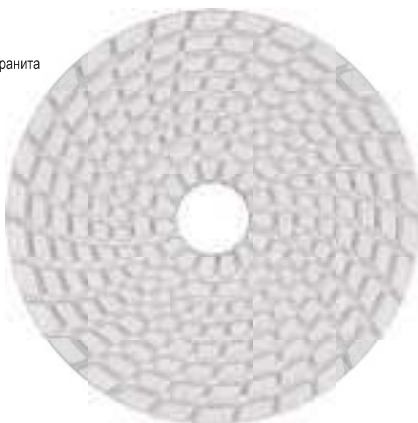

- Application: gres tile, granite, stone, concrete
• Przeznaczenie: gres, granit, kamień, beton



For YT-82161
Dla YT-82161

YATO	Grit / Ziarnistość	Ø [mm]	max c [min ⁻¹]	
YT-48200	D50	100	4500	50/300
YT-48201	D100	100	4500	50/300
YT-48202	D200	100	4500	50/300
YT-48203	D400	100	4500	50/300
YT-48204	D800	100	4500	50/300
YT-48205	D1500	100	4500	50/300
YT-48206	D3000	100	4500	50/300

- EN Diamond grinding cup wheel
PL Tarcza szlifująca diamentowa
DE Diamant Schleiftopf Schleifteller
RU Алмазный диск шлифовальный
CZ Diamantový brusný kotouč
HU Gyémánt csiszoló kúpos
- RO Disc cupa diamentat pt. slefuit
FR Disque diamant
IT Disco diamantato
ES Disco diamante de lijar
CN 金刚石杯型磨轮



- Application: concrete, clinkier, natural stone, screed
• Przeznaczenie: beton utwardzony, klinkier, kamień naturalny, jastrych

YATO	ØA [mm]	Ød [mm]	max c [min ⁻¹]	Segment size / Rozmiar segmentu [mm]	
YT-6030	125	22.2	12200	5x7.5	20
YT-6032	125	22.2	12200	4.5x20	20

- EN Diamond core bit drilling holes for sockets
PL Diamentowe wiertło koronowe
DE Diamant-Bohrkrone
RU Алмазное сверло корончатое
CZ Diamantový korunkový vrták
HU Gyémánt fúrókorona
- RO Carota diamentata pt. beton
FR Trépiéd à mur diamantées
IT Corona diamentata per calcestruzzo
ES Broca corona de diamante
CN 金刚石薄壁钻

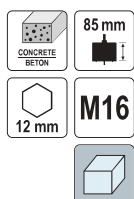

- Application: concrete, calcium-silicate brick, porous ceramics
• Przeznaczenie: beton utwardzony, cegła silikatowa, ceramika poryzowana

YATO	Ø [mm]	max c [min ⁻¹]	Segment size / Rozmiar segmentu [mm]	
YT-6045	65	1030	3.5x10x24	24
YT-6046	82	850	3.5x10x24	20

- EN Diamond grinding cup wheel
PL Tarcza szlifująca diamentowa
DE Diamant Schleiftopf Schleifteller
RU Алмазный диск шлифовальный
CZ Diamantový brusný kotouč
HU Gyémánt csiszoló kúpos
- RO Disc cupa diamentat pt. slefuit
FR Disque diamant
IT Disco diamantato
ES Disco diamante de lijar
CN 金刚石磨轮



- Application: concrete, screed
• Przeznaczenie: beton, jastrych

YATO	ØA [mm]	Ød [mm]	max c [min ⁻¹]	Segment size / Rozmiar segmentu [mm]	For / Dla	
YT-60322	125	22.2	12200	5x9	YT-82110, YT-82101	30
YT-60323	180	22.2	6600	5x9	YT-82341, YT-82110	10

- EN Diamond core bit drilling holes for sockets
PL Diamentowe wiertło koronowe
DE Diamant-Bohrkrone
RU Алмазное сверло корончатое
CZ Diamantový korunkový vrták
HU Gyémánt fúrókorona
RO Carota diamentata pt. beton
FR Trépiéd à mur diamantées
IT Corona diamentata per calcestruzzo
ES Broca corona de diamante
CN 激光薄壁钻



For YT-81980
Dla YT-81980



YATO	Ø [mm]	Segment size / Rozmiar segmentu [mm]	
YT-60371	32	4x8x20	10
YT-60372	42	4x8x20	10
YT-60373	52	4x8x24	10
YT-60374	68	4x8x24	8
YT-60375	82	4x8x24	4
YT-60376	102	4x8x24	4
YT-60377	122	4x8x24	4
YT-60378	152	4x8x24	2
YT-60379	182	4x8x24	2

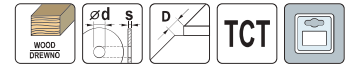

- EN TCT circular saw blade for wood
- PL Pila tarczowa do drewna z węglikiem wolframu
- DE Kreissägeblatt HM-Bestückt
- RU Диск пильный с карбидом вольфрама
- CZ Kotoučová pila na dřevo z karbidem wolframu
- HU Wolframkarbidos körfűrész fához
- RO Ferăstrău circular cu dinți din wolfram pt. lemn
- FR Lame de scie circulaire carburée
- IT Lama tronatrice taglio legno
- ES Disco de sierra con carbono de tungsteno
- CN 木工圆锯片



• Application: for cutting wood and plastics



• Przeznaczenie: do cięcia drewna, płyt drewnopochodnych, tworzyw sztucznych

YATO 	Ø [mm]	Ød [mm]	max. ω [min ⁻¹]	D [mm]	s [mm]	T	For / Dla	
YT-6050	130	16.0	10000	2.8	2.0	24	-	25/50
YT-6052	140	20.0	10000	2.8	2.0	16	-	25/50
YT-60522	140	20.0	11000	2.8	2.0	30	-	25/50
YT-6053	140	16.0	10000	2.8	2.0	30	-	25/50
YT-60533	150	20.0	10000	2.8	2.0	30	-	25/50
YT-6055	160	20.0	9500	2.8	2.0	18	79254	25/50
YT-6056	160	30.0	9500	2.8	2.0	24	79254	25/50
YT-6057	160	30.0	9500	2.8	2.0	36	-	25/50
YT-60577	160	20.0	9500	2.2	1.5	36	79254	25/50
YT-6058	160	20.0	9500	2.8	2.0	48	79254	25/50
YT-60581	160	20.0	9500	2.2	1.5	60	-	25/50
YT-60590	165	16.0	9500	2.2	1.5	24	YT-82810, YT-82811	25/50
YT-60591	165	16.0	9500	2.2	1.5	36	YT-82810, YT-82811	25/50
YT-60582	170	16.0	9500	3.2	2.2	12	-	25/50
YT-60583	170	16.0	9500	3.2	2.2	40	-	25/50
YT-6060	184	30.0	9000	3.2	2.2	24	YT-82172	25/50
YT-6061	184	30.0	9000	3.2	2.2	40	YT-82172	25/50
YT-6062	184	30.0	9000	3.2	2.2	50	YT-82172	25/50
YT-6063	185	20.0	9000	2.4	1.4	18	YT-82151	10/20
YT-60621	185	20.0	9000	2.2	1.5	24	YT-82151	25/50
YT-60622	185	20.0	9000	2.2	1.5	36	YT-82151	25/50
YT-60633	190	16.0	8500	3.2	2.2	40	YT-82150	10/20
YT-60634	190	20.0	8500	2.2	1.5	24	YT-82150	10/20
YT-60635	190	20.0	8500	2.2	1.5	36	YT-82150	10/20
YT-60636	190	20.0	8500	2.2	1.5	60	-	10/20
YT-60488	190	30.0	8500	3.2	2.2	20	-	10/20
YT-60489	190	30.0	8500	3.2	2.2	40	-	10/20
YT-6065	200	30.0	8000	3.2	2.2	24	-	10/20
YT-60652	200	30.0	8000	3.2	2.2	40	-	10/20
YT-6066	205	18.0	6000	3.2	2.0	24	-	10/20
YT-60665	210	30.0	7500	3.2	2.2	20	-	10/20

YATO 	Ø [mm]	Ød [mm]	max. ω [min ⁻¹]	D [mm]	s [mm]	T	For / Dla	
YT-6067	210	30.0	8000	3.2	2.2	40	-	10/20
YT-6068	210	30.0	8000	3.2	2.2	60	-	10/20
YT-60682	216	30.0	7500	3.2	2.2	48	-	10/20
YT-60685	235	25.4	7000	2.8	1.8	24	YT-82153	10/20
YT-60686	235	25.4	7000	2.8	1.8	36	YT-82153	10/20
YT-60687	235	25.4	7000	2.8	1.8	60	YT-82153	10/20
YT-6070	250	30.0	6000	3.2	2.2	24	YT-82165	10/20
YT-6071	250	30.0	6000	3.2	2.2	40	YT-82165	10/20
YT-6072	250	30.0	6000	3.2	2.2	60	YT-82165	10/20
YT-60731	255	30.0	6000	30.0	2.0	24	YT-82171, YT-82173, YT-82165	10/20
YT-60732	255	30.0	6000	3.0	2.0	36	YT-82173	10/20
YT-60733	255	30.0	6000	3.0	2.0	60	YT-82173	10/20
YT-6075	300	30.0	6000	3.2	2.2	24	YT-82175	10
YT-6076	300	30.0	5000	3.2	2.2	40	YT-82175	10
YT-6077	300	30.0	5000	3.2	2.2	60	YT-82175	10
YT-6078	300	30.0	5000	3.2	2.2	96	YT-82175	10
YT-60782	305	30.0	5000	3.2	2.2	24	YT-82175	10
YT-60783	305	30.0	5000	3.2	2.2	40	YT-82175	10
YT-60784	305	30.0	5000	3.2	2.2	60	YT-82175	10
YT-60785	305	30.0	5000	3.2	2.2	96	YT-82175	10
YT-60791	315	30.0	4900	3.2	2.2	40	-	10
YT-60792	315	30.0	4500	3.5	2.5	48	-	10
YT-60794	315	30.0	4500	3.5	2.5	80	-	10
YT-60795	315	30.0	4900	3.2	2.2	96	-	10
YT-6080	350	30.0	4500	3.5	2.5	28	-	10
YT-6081	350	30.0	4500	3.5	2.5	40	-	10
YT-6082	350	30.0	4500	3.5	2.5	54	-	10
YT-6083	350	30.0	4500	3.5	2.5	84	-	10
YT-6085	400	30.0	4000	3.8	2.8	32	-	10
YT-6086	400	30.0	4000	3.8	2.8	60	-	10

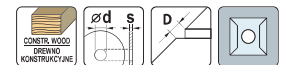
- EN Circular saw blade for wood
- PL Pila tarczowa do drewna
- DE Kreissägeblatt
- RU Диск пильный по дереву
- CZ Kotoučová pila na dřevo
- HU Körfűrész fához
- RO Ferăstrău circular pt. lemn
- FR Lame de scie pour bois
- IT Lama taglio legno
- ES Disco de sierra
- CN 木工尖齿片



YATO 	Ø [mm]	Ød [mm]	max. ω [min ⁻¹]	D [mm]	s [mm]	T	
YT-60871	500	32	3000	4.5	2.9	60	4
YT-60872	500	32	3000	4.5	2.9	80	4

EN TCT circular saw blade for structural wood
 PL Pila tarczowa z węglikiem wolframu do cięcia drewna konstrukcyjnego
 DE Kreissägeblatt HM-Bestuckt von Holzkonstruktionen
 RU Диск пильный твердого сплава для резки строительной конструкционной древесины
 CZ Kotoučová pila s karbidem wolframu k řezání konstrukčního dřeva
 HU Wolfram-karbid szegmens fűrészárca szerkezeti fához
 RO Ferăstrău circular cu dinți din wolfram pt. tăierea lemnului pt. construcții
 FR Lame de scie circulaire carbure pour construction bois
 IT Lama al tungsteno da legno
 ES Disco de sierra con carbono de tungsteno para corte de madera estructural
 CN 木工圆锯片

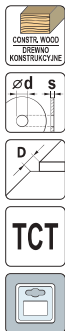

YATO	Ø [mm]	Ød [mm]	max. c [min ⁻¹]	D [mm]	s [mm]	T	
YT-60480	160	20	9500	2.2	1.5	24	25/50
YT-60482	180	20	9000	2.4	1.8	36	20/40
YT-60484	250	30	6000	2.4	1.8	48	10/20

EN TCT circular saw blade for structural wood
 PL Pila tarczowa z węglikiem wolframu do cięcia drewna konstrukcyjnego
 DE Kreissägeblatt HM-Bestuckt von Holzkonstruktionen
 RU Диск пильный твердого сплава для резки строительной конструкционной древесины
 CZ Kotoučová pila s karbidem wolframu k řezání konstrukčního dřeva
 HU Wolfram-karbid szegmens fűrészárca szerkezeti fához
 RO Ferăstrău circular cu dinți din wolfram pt. tăierea lemnului pt. construcții
 FR Lame de scie circulaire carbure pour construction bois
 IT Lama al tungsteno da legno
 ES Disco de sierra con carbono de tungsteno para corte de madera estructural
 CN 锯钉片

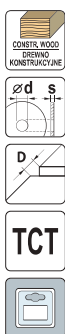

YATO	Ø [mm]	Ød [mm]	max. c [min ⁻¹]	D [mm]	s [mm]	T	
YT-60628	185	20	9000	2.4	1.8	14	25/50

EN PVC cutting blade
 PL Pila tarczowa do cięcia PVC
 DE PVC-Trennscheibe
 RU Режущий диск ПВХ
 CZ PVC řezný disk
 HU Kőfűrészárca
 RO Panza de ferăstrău circular PVC
 FR Disque de coupe en PVC
 IT Disco da taglio per PVC
 ES Sierra circular CMT para corte PVC
 CN 锯塑料片



EN TCT circular saw blade for aluminium
 PL Pila tarczowa do aluminium z węglikiem wolframu
 DE Hartmetallbestückt Kreissägeblatt für Aluminium
 RU Диск пильный по алюминию
 CZ Kotoučová pila na hliník s karbidem wolframu
 HU Wolframkarbidos körfűrészlap, alumíniumhoz
 RO Disc circular pt. aluminiu
 FR Lame de scie circulaire pour aluminium
 IT Lama tronatrice alluminio
 ES Disco de sierra con carbono
 CN 圆锯片

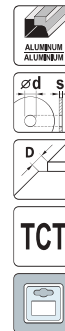

• Application: for cutting aluminium profiles, laminates, plexi, corian and other plastics
 • Negative angle of teeth
 • Przeznaczenie: do cięcia profili aluminiowych, laminatów, pleksi, korianu, tworzyw sztucznych
 • Negatywny kąt natarcia zębów

YATO	Ø [mm]	Ød [mm]	max. c [min ⁻¹]	D [mm]	s [mm]	T	
YT-60905	160	20	9500	2.2	1.5	52	25/50
YT-60907	180	20	9000	2.2	1.5	60	20/40
YT-6091	200	30	8000	3.0	2.2	60	10/20
YT-6093	210	30	8000	3.0	2.2	72	10/20
YT-6095	250	30	6000	3.0	2.2	100	10/20
YT-6097	300	30	5000	3.0	2.2	100	10
YT-6099	350	30	4500	3.2	2.5	100	10

EN Blade for cutting laminate and plywood
 PL Pila tarczowa do cięcia paneli i płyt meblowych
 DE Kreissägeblatte für Laminatböden
 RU Ламинированный режущий диск
 CZ Laminátový řezací kotouč
 HU Kőfűrészlap
 RO Disc de tăiere laminat
 FR Disque de coupe en stratifié
 IT Disco da taglio per pannelli e pannelli per mobili
 ES Disco de corte laminado
 CN 普通木工片



YATO	Ø [mm]	Ød [mm]	max. c [min ⁻¹]	D [mm]	s [mm]	T	
YT-60631	185	20	9000	1.7	1.4	140	25/50

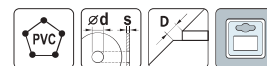

YATO	Ø [mm]	Ød [mm]	max. c [min ⁻¹]	D [mm]	s [mm]	T	
YT-60627	185	20	9000	2.5	1.5	60	25/50

EN Metal cutting disc
 PL Tarcza do cięcia metalu
 DE Trennscheibe für Metall
 RU Диск отрезной по металлу
 CZ Kotouč pro řezání kovu
 HU Vágókorong fémez
 RO Disc debitat metal
 FR Disque à tronçonner pour métal
 IT Disco per taglio metallo
 ES Disco cortador para metal
 CN 金属切割片



INOX

max 80 m/s

EN Metal cutting disc
 PL Tarcza do cięcia metalu
 DE Trennscheibe für Metall
 RU Диск отрезной по металлу
 CZ Kotouč pro řezání kovu
 HU Vágókorong fémez
 RO Disc debitat metal
 FR Disque à tronçonner pour métal
 IT Disco per taglio metallo
 ES Disco cortador para metal
 CN 金属切割片



max 80 m/s

YATO	ØA [mm]	Ød [mm]	D [mm]	max c [min ⁻¹]	pcs / szt.	
YT-6101	115	22	1.2	13200	5	25/200
YT-61025	125	22.23	1.0	12200	5	50/400
YT-6103	125	22	1.2	12200	5	25/200
YT-6104	125	22	2.5	12200	5	25/200
YT-6105	180	22	1.5	8600	5	25/50
YT-6107	230	22	2.0	6500	5	25/50

YATO	ØA [mm]	Ød [mm]	D [mm]	max c [min ⁻¹]	pcs / szt.	
YT-5920	115	22	1.2	13200	5	25/200
YT-5923	125	22	1.2	12200	5	25/200
YT-5924	125	22	2.5	12200	5	25/200
YT-6110	125	22	3.2	12200	5	25/200
YT-5925	180	22	1.5	8600	5	25/50
YT-5927	230	22	2.0	6500	5	25/50
YT-6112	230	22	3.2	6500	5	25/50
YT-6113	300	32	3.2	5100	5	25
YT-6136	350	32	3.5	4400	5	25
YT-6137	400	32	4.0	3800	5	25

EN Metal cutting disc
 PL Tarcza do cięcia metalu
 DE Trennscheibe für Metall
 RU Диск отрезной по металлу
 CZ Kotouč pro řezání kovu
 HU Vágókorong fémez
 RO Disc debitat metal
 FR Disque à tronçonner pour métal
 IT Disco per taglio metallo
 ES Disco cortador para metal
 CN 金属切割片



max 80 m/s

EN Metal cutting disc
 PL Tarcza do cięcia metalu
 DE Trennscheibe für Metall
 RU Диск отрезной по металлу
 CZ Kotouč pro řezání kovu
 HU Vágókorong fémez
 RO Disc debitat metal
 FR Disque à tronçonner pour métal
 IT Disco per taglio metallo
 ES Disco cortador para metal
 CN 金属切割片



max 80 m/s

For YT-82180
 Dla YT-82180

YATO	ØA [mm]	Ød [mm]	D [mm]	max c [min ⁻¹]	
YT-61132	355	25.4	3.2	4400	25

• Depressed center
 • Wypukła

YATO	ØA [mm]	Ød [mm]	D [mm]	max c [min ⁻¹]	pcs / szt.	
YT-6116	125	22	2.5	12200	5	25/200
YT-6120	230	22	3.2	6500	5	25/50

EN Metal grinding disc
 PL Tarcza do szlifowania metalu
 DE Metall-Schleif-scheibe
 RU Круги для шлифования по металлу
 CZ Kotouč pro broušení kovu
 HU Vágókorong fémez
 RO Disc pt. şlefuit metal
 FR Disque de polissage pour métaux
 IT Disco per rettifica metallo
 ES Disco cortador para metalo
 CN 树脂磨片



max 80 m/s

EN Metal grinding disc
 PL Tarcza do szlifowania metalu
 DE Metall-Schleif-scheibe
 RU Круги для шлифования по металлу
 CZ Kotouč pro broušení kovu
 HU Vágókorong fémez
 RO Disc pt. şlefuit metal
 FR Disque de polissage pour métaux
 IT Disco per rettifica metallo
 ES Disco cortador para metalo
 CN 树脂磨片



INOX

max 80 m/s

• Depressed center
 • Wypukła

YATO	ØA [mm]	Ød [mm]	D [mm]	max c [min ⁻¹]	pcs / szt.	
YT-6121	115	22	6.0	13200	5	25/100
YT-6124	125	22	6.0	12200	5	30/120
YT-6126	125	22	8.0	12200	5	25/100
YT-6125	230	22	6.0	6500	5	5/30

• Depressed center
 • Wypukła

YATO	ØA [mm]	Ød [mm]	D [mm]	max c [min ⁻¹]	pcs / szt.	
YT-5947	125	22	6.8	12200	5	25/100

EN Stone cutting disc
PL Tarcza do cięcia kamienia
DE Stein-Trennscheibe
RU Диск отрезной по камню
CZ Kotouč pro řezání kamene
HU Vágókorong kőhöz
RO Disc pt. tăiat piatră
FR Disque de coupe pour granit
IT Disco per taglio pietra
ES Disco cortador de piedra
CN 树脂切片



EN Stone grinding disc
PL Tarcza do szlifowania kamienia
DE Stein-Schleifscheibe
RU Диск для шлифования по камню
CZ Kotouč pro broušení kamene
HU Csiszolókorong kőhöz
RO Disc pt. șlefuit piatră
FR Disque de polissage pour granit
IT Disco per rettificata pietra
ES Disco cortador de piedra
CN 树脂切片



• Depressed center

• Wypukła

YATO	ØA [mm]	Ød [mm]	max c [min ⁻¹]	D [mm]	pcs / szt.	☐
YT-5930	115	22	13200	1.5	5	25/200
YT-5932	125	22	12200	1.5	5	25/200
YT-5933	125	22	12200	3.2	5	25/200
YT-5935	230	22	6500	3.2	5	25/50

YATO	ØA [mm]	Ød [mm]	D [mm]	max c [min ⁻¹]	pcs / szt.	☐
YT-6132	115	22	6.0	13200	5	25/100
YT-6133	125	22	6.8	12200	5	25/100

EN Universal grinding disc
PL Tarcza szlifierska uniwersalna
DE Universelle Schleifscheibe
RU Диск шлифовальный универсальный
CZ Brusný kotouč univerzální
HU Univerzális csiszolókorong
RO Disc de rectificat
FR Disque de ponçage universel
IT Disco di molatura
ES Muela abrasiva universal
CN 塑基砂盘



YATO	Grit / Ziarnistość	ØA [mm]	Ød [mm]	max c [min ⁻¹]	☐
YT-83260	P8	125	22.2	17000	100
YT-83261	P16	125	22.2	17000	100
YT-83262	P24	125	22.2	17000	100
YT-83263	P36	125	22.2	17000	100
YT-83264	P60	125	22.2	17000	100
YT-83265	P80	125	22.2	17000	100
YT-83266	P120	125	22.2	17000	100

EN Rubber disc for angle grinder
PL Przystawka do szlifierek kątowych
DE Klett-Gummihaftstützeller mit Gewindeflansch
RU Диск резиновый с липучкой для шлифмашины
CZ Euro disk do úhelníků ze zipem
HU Csiszolókorong kőhöz
RO Suport disc polizor unghiular
FR Disque caoutchouc avec velcro
IT Disco con velcro e accessori
ES Disco de goma para angul con velcro
CN 抛光盘



YATO	Ø [mm]	max c [min ⁻¹]	☐
YT-47770	230	6600	25

EN Tapered rasp disc
PL Tarnik skośny
DE Raspelscheibe schräge Oberfläche
RU Диск фреза универсальный по дереву для УШМ
CZ Rotací rasple
HU Rotációs rászply
RO Disc raspel
FR Disque râpe
IT Disco raspa obliquo
ES Disco escofina
CN 圆锥锉刀盘



- Grinding, milling
- Wood, cellular concrete, plastics, gypsum, drywall
- Szlifowanie, frezowanie
- Drewno, beton komórkowy, tworzywa sztuczne, gips, płyty gipsowo-kartonowe

YATO	Ø [mm]	Ød [mm]	max c [min ⁻¹]	[#]	☐
YT-59164	115	22.2	13000	2	10
YT-59165	125	22.2	13000	2	10

EN Tapered rasp disc
PL Tarnik skośny
DE Raspelscheibe schräge Oberfläche
RU Диск фреза универсальный по дереву для УШМ
CZ Rotací rasple
HU Rotációs rászply
RO Disc raspel
FR Disque râpe
IT Disco raspa obliquo
ES Disco escofina
CN 圆锥锉刀盘



- Grinding, milling
- Wood, cellular concrete, plastics, gypsum, drywall
- Szlifowanie, frezowanie
- Drewno, beton komórkowy, tworzywa sztuczne, gips, płyty gipsowo-kartonowe

YATO	Ø [mm]	Ød [mm]	max c [min ⁻¹]	[#]	☐
YT-59166	115	22.2	13000	1	10
YT-59167	125	22.2	13000	1	10

EN Carving rasp disc
 PL Tamnik promieniowy
 DE Rundraspelfräscheibe
 RU Диск-фреза закругленный для УШМ
 CZ Rašple rotační oblá
 HU ívelt ráspolykorong
 RO Disc raspel pt. sculptat
 FR Disque de sculpture
 IT Disco a raspa stondato
 ES Disco escofina curvo para tallado
 CN 雕刻锉刀盘

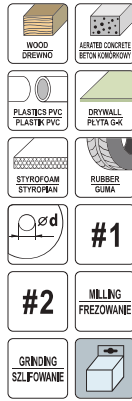

- Grinding, milling
- Wood, cellular concrete, plastics, gypsum, drywall
- Szlifowanie, frezowanie
- Drewno, beton komórkowy, tworzywa sztuczne, gips, płyty gipsowo-kartonowe

YATO	Ø [mm]	Ød [mm]	H [mm]	max C [min ⁻¹]	[#]	
YT-59155	120	22.2	13	13000	1	10
YT-59156	120	22.2	13	13000	2	10

EN Tapered rasp disc
 PL Tamnik wypukły
 DE Raspelscheibe gekröpft
 RU Диск фреза универсальный по дереву для УШМ
 CZ Rotační rašple
 HU Rotációs ráspoly
 RO Disc raspel
 FR Disque râpe
 IT Disco raspa convesso
 ES Disco escofina
 CN 锯片

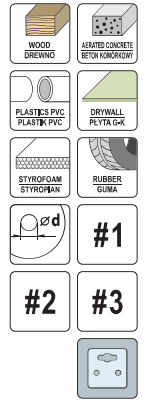

- Grinding, milling
- Wood, cellular concrete, plastics, gypsum, drywall
- Szlifowanie, frezowanie
- Drewno, beton komórkowy, tworzywa sztuczne, gips, płyty gipsowo-kartonowe

YATO	Ø [mm]	Ød [mm]	H [mm]	max C [min ⁻¹]	[#]	
YT-59168	125	22.2	13000	1	10	
YT-59169	125	22.2	13000	2	10	
YT-59170	125	22.2	13000	3	10	

EN Milling rasp disc
 PL Frez tamkowy
 DE Raspelfräscheibe
 RU Диск-фреза шлифовальный для УШМ
 CZ Rotační rašple frézovací
 HU Ráspolykorong
 RO Disc raspel pt. frezat
 FR Disque à râpe de fraisage
 IT Disco a raspa
 ES Disco escofina
 CN 铣刀盘

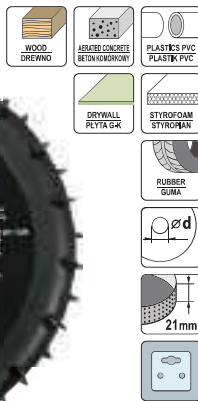

- Milling, grooving
- Wood, cellular concrete, plastics, gypsum, drywall
- Frezowanie, bruzdowanie
- Drewno, beton komórkowy, tworzywa sztuczne, gips, płyty gipsowo-kartonowe

YATO	Ø [mm]	Ød [mm]	+/- [mm]	max C [min ⁻¹]	
YT-59175	90	22.2	21	13000	10
YT-59176	118	22.2	21	13000	10

EN Milling rasp disc
 PL Frez tamkowy
 DE Raspelfräscheibe
 RU Диск-фреза шлифовальный для УШМ
 CZ Rotační rašple frézovací
 HU Ráspolykorong
 RO Disc raspel pt. frezat
 FR Disque à râpe de fraisage
 IT Disco a raspa
 ES Disco escofina
 CN 铣刀盘



- Milling, grinding, grooving
- Wood, cellular concrete, plastics, gypsum, drywall
- Frezowanie, szlifowanie, bruzdowanie
- Drewno, beton komórkowy, tworzywa sztuczne, gips, płyty gipsowo-kartonowe

YATO	Ø [mm]	Ød [mm]	H [mm]	max C [min ⁻¹]	[#]	
YT-59178	120	22.2	6	13000	1	10
YT-59179	120	22.2	12	13000	1	10

EN Rasp milling cutter
 PL Frez tamkowy pełny wypukły
 DE Raspelfräscheibe konvexe
 RU Универсальная фреза
 CZ Rotační rašple
 HU Rotációs ráspoly
 RO Disc raspel
 FR Fraise râpe
 IT Fresa raspa a disco universale
 ES Disco escofina
 CN 锯片

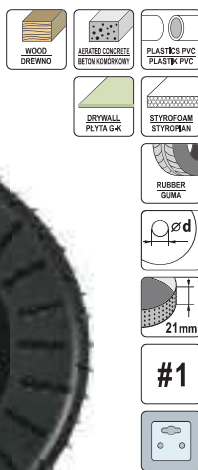

- Milling, grinding, grooving
- Wood, cellular concrete, plastics, gypsum, drywall
- Frezowanie, szlifowanie, bruzdowanie
- Drewno, beton komórkowy, tworzywa sztuczne, gips, płyty gipsowo-kartonowe

YATO	Ø [mm]	Ød [mm]	+/- [mm]	max C [min ⁻¹]	[#]	
YT-59177	118	22.2	21	13000	1	10

EN Depressed center milling rasp disc
 PL Frez tamkowy pełny wypukły
 DE Raspelfräscheibe konvexe
 RU Диск-фреза выпуклый для УШМ
 CZ Rotační rašple frézovací vypouklá
 HU Rotációs ráspolykorong széles
 RO Disc depresat raspel pt. frezat
 FR Disque à râpe de fraisage arrondi
 IT Disco a raspa a centro depresso
 ES Disco escofina con centro deprimido
 CN 凹陷式中心铣链盘



- Milling, grinding, grooving
- Wood, cellular concrete, plastics, gypsum, drywall
- Frezowanie, szlifowanie, bruzdowanie
- Drewno, beton komórkowy, tworzywa sztuczne, gips, płyty gipsowo-kartonowe

YATO	Ø [mm]	Ød [mm]	H [mm]	max C [min ⁻¹]	[#]	
YT-59180	120	22.2	6	13000	1	10
YT-59181	120	22.2	6	13000	2	10
YT-59182	120	22.2	12	13000	1	10
YT-59183	120	22.2	12	13000	2	10
YT-59184	120	22.2	18	13000	1	10
YT-59185	120	22.2	18	13000	2	10

EN Tin snips
PL Nożyce do cięcia blachy
DE Blechscherer
RU Ножницы по металлу

CZ Nůžky na plech
HU Lemezvágó olló
RO Foarfece pt. tablă
FR Cisaille à tôle

IT Cesioie per lamiere
ES Tijeras para chapas
CN 航空剪



CrMo

INCREASED CUTTING POWER
ZWIĘKSZONA SIŁA CIĘCIA



DIN 6438 HRC 60-62



DIN 6438 HRC 60-62

YATO	L [mm]	Cutting length / Długość cięcia [mm]	Cooper / Miedź [mm]	Cold rolled steel / Stal zimnowalcowana [mm]	Steel HRC35 / Stal HRC35 [mm]	SS 304 / Stal nierdzewna 304 [mm]	
YT-1910	260	35	1.8	1.5	1.0	0.9	6/36

YATO	L [mm]	Cutting length / Długość cięcia [mm]	Cooper / Miedź [mm]	Cold rolled steel / Stal zimnowalcowana [mm]	Steel HRC35 / Stal HRC35 [mm]	SS 304 / Stal nierdzewna 304 [mm]	
YT-1915	235	30	1.5	1.2	1.0	0.7	6/36



DIN 6438 HRC 60-62



250 mm HRC 56-62
HIGH FREQUENCY HARDENING
HARTOWANIE IMPULSOWE
SERRATED EDGES
ZĄBKOWANE KRAWĘDZIE

YATO	L [mm]	Cutting length / Długość cięcia [mm]	Cooper / Miedź [mm]	Cold rolled steel / Stal zimnowalcowana [mm]	Steel HRC35 / Stal HRC35 [mm]	SS 304 / Stal nierdzewna 304 [mm]	
YT-1918	260	32	1.8	1.5	1.0	0.9	6/36

YATO	L [mm]	Cutting length / Długość cięcia [mm]	Cooper / Miedź [mm]	Cold rolled steel / Stal zimnowalcowana [mm]	Steel HRC35 / Stal HRC35 [mm]	SS 304 / Stal nierdzewna 304 [mm]	
YT-1960	250	40	2.0	1.5	1.0	0.8	6/36

EN Tin snips
PL Nożyce do cięcia blachy
DE Blechscherer

RU Ножницы по металлу
CZ Nůžky na plech
HU Lemezvágó olló

RO Foarfece pt. tablă
FR Cisaille à tôle
IT Cesioie per lamiere

ES Tijeras para chapas
CN 台式航空剪



90°

HRC 60-62

CrMo

SERRATED EDGES
ZĄBKOWANE KRAWĘDZIE



YATO	L [mm]	Cutting length / Długość cięcia [mm]	Cooper / Miedź [mm]	Cold rolled steel / Stal zimnowalcowana [mm]	Steel HRC35 / Stal HRC35 [mm]	SS 304 / Stal nierdzewna 304 [mm]	
YT-1913	225	30	0.78	0.53	0.46	0.36	6/36

EN Tin snips
PL Nożyce do cięcia blachy
DE Blechscherer
RU Ножницы по металлу

CZ Nůžky na plech
HU Lemezvágó olló
RO Foarfece pt. tablă
FR Cisaille à tôle

IT Cesioie per lamiere
ES Tijeras para chapas
CN 航空剪



CrMo

INCREASED CUTTING POWER
ZWIĘKSZONA SIŁA CIĘCIA



DIN 6438 HRC 60-62

YATO	L [mm]	Cutting length / Długość cięcia [mm]	Cooper / Miedź [mm]	Cold rolled steel / Stal zimnowalcowana [mm]	Steel HRC35 / Stal HRC35 [mm]	SS 304 / Stal nierdzewna 304 [mm]	
YT-1912	260	35	1.8	1.5	1.0	0.9	6/36



DIN 6438 HRC 60-62



250 mm HRC 56-62
SERRATED EDGES
ZĄBKOWANE KRAWĘDZIE
HIGH FREQUENCY HARDENING
HARTOWANIE IMPULSOWE

YATO	L [mm]	Cutting length / Długość cięcia [mm]	Cooper / Miedź [mm]	Cold rolled steel / Stal zimnowalcowana [mm]	Steel HRC35 / Stal HRC35 [mm]	SS 304 / Stal nierdzewna 304 [mm]	
YT-1922	290	75	1.1	0.94	0.7	0.53	6/36

YATO	L [mm]	Cutting length / Długość cięcia [mm]	Cooper / Miedź [mm]	Cold rolled steel / Stal zimnowalcowana [mm]	Steel HRC35 / Stal HRC35 [mm]	SS 304 / Stal nierdzewna 304 [mm]	
YT-1962	250	45	2.0	1.5	1.0	0.8	6/36

EN Tin snips
 PL Nożyce do cięcia blachy
 DE Blechscherer
 RU Ножницы по металлу

CZ Nůžky na plech
 HU Lemezvágó olló
 RO Foarfece pt. tablă
 FR Cisaille à tôle

IT Cesioie per lamiere
 ES Tijeras para chapas
 CN 航空剪



DIN 6438 **HRC 60-62**

DIN 6438 **HRC 60-62**

YATO	L [mm]	Cutting length / Długość cięcia [mm]	Cooper / Miedź [mm]	Cold rolled steel / Stal zimnowalcowana [mm]	Steel HRC35 / Stal HRC35 [mm]	SS 304 / Stal nierdzewna 304 [mm]	6/36
YT-1911	260	35	1.8	1.5	1.0	0.9	6/36

YATO	L [mm]	Cutting length / Długość cięcia [mm]	Cooper / Miedź [mm]	Cold rolled steel / Stal zimnowalcowana [mm]	Steel HRC35 / Stal HRC35 [mm]	SS 304 / Stal nierdzewna 304 [mm]	6/36
YT-1916	235	30	1.5	1.2	1.0	0.7	6/36



DIN 6438 **HRC 60-62**

250 mm **HRC 56-62** **SERRATED EDGES ZĄBKOWANE KRAWĘDZIE** **HIGH FREQUENCY HARDENING HARTOWANIE IMPULSOWE**

YATO	L [mm]	Cutting length / Długość cięcia [mm]	Cooper / Miedź [mm]	Cold rolled steel / Stal zimnowalcowana [mm]	Steel HRC35 / Stal HRC35 [mm]	SS 304 / Stal nierdzewna 304 [mm]	6/36
YT-1919	260	32	1.8	1.5	1.0	0.9	6/36

YATO	L [mm]	Cutting length / Długość cięcia [mm]	Cooper / Miedź [mm]	Cold rolled steel / Stal zimnowalcowana [mm]	Steel HRC35 / Stal HRC35 [mm]	SS 304 / Stal nierdzewna 304 [mm]	6/36
YT-1961	250	40	2.0	1.5	1.0	0.8	6/36

EN Tin snips
 PL Nożyce do cięcia blachy
 DE Blechscherer
 RU Ножницы по металлу
 CN 台式航空剪

CZ Nůžky na plech
 HU Lemezvágó olló
 RO Foarfece pt. tablă
 FR Cisaille à tôle

IT Cesioie per lamiere
 ES Tijeras para chapas
 CN 台式航空剪

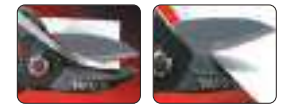

YATO	L [mm]	Cutting length / Długość cięcia [mm]	Cooper / Miedź [mm]	Cold rolled steel / Stal zimnowalcowana [mm]	Steel HRC35 / Stal HRC35 [mm]	SS 304 / Stal nierdzewna 304 [mm]	6/36
YT-1914	225	30	0.78	0.53	0.46	0.36	6/36

EN Tin snips
 PL Nożyce do cięcia blachy
 DE Blechscherer
 RU Ножницы по металлу
 CZ Nůžky na plech
 HU Lemezvágó olló

RO Foarfece pt. tablă
 FR Cisaille à tôle

IT Cesioie per lamiere
 ES Tijeras para chapas
 CN 航空剪



YATO	L [mm]	Cutting length / Długość cięcia [mm]	Cooper / Miedź [mm]	Cold rolled steel / Stal zimnowalcowana [mm]	Steel HRC35 / Stal HRC35 [mm]	SS 304 / Stal nierdzewna 304 [mm]	6/24
YT-1900	260	30	0.94	0.78	0.6	0.45	6/24

EN Tin snips
 PL Nożyce do cięcia blachy
 DE Blechscherer
 RU Ножницы по металлу

CZ Nůžky na plech
 HU Lemezvágó olló
 RO Foarfece pt. tablă
 FR Cisaille à tôle

IT Cesioie per lamiere
 ES Tijeras para chapas
 CN 航空剪



YATO	L [mm]	Cutting length / Długość cięcia [mm]	Cooper / Miedź [mm]	Cold rolled steel / Stal zimnowalcowana [mm]	Steel HRC35 / Stal HRC35 [mm]	SS 304 / Stal nierdzewna 304 [mm]	6/24
YT-1901	260	30	0.94	0.78	0.6	0.45	6/24

YATO	L [mm]	Cutting length / Długość cięcia [mm]	Cooper / Miedź [mm]	Cold rolled steel / Stal zimnowalcowana [mm]	Steel HRC35 / Stal HRC35 [mm]	SS 304 / Stal nierdzewna 304 [mm]	6/24
YT-1902	300	50	0.94	0.78	0.6	0.45	6/24

EN Tin snips
PL Nożyce do cięcia blachy
DE Blechscherer
RU Ножницы по металлу
CZ Nůžky na plech
HU Lemezvágó olló

RO Foarfece pt. tablă
FR Cisaille à tôle
IT Cesioie per lamiera
ES Tijeras para chapas
CN 铁皮剪



HRC
55-60

S55C

HIGH FREQUENCY
HARDENING
HARTONANIE
IMPULSOWE



YATO	L [mm]	Cutting length / Długość cięcia [mm]	Cooper / Miedz [mm]	Cold rolled steel / Stal zimnowalcowana [mm]	Steel HRC35 / Stal HRC35 [mm]	SS 304 / Stal nierdzewna 304 [mm]	
YT-1970	260	42	2.0	1.4	1.0	1.0	6/36

EN Tin snips
PL Nożyce do cięcia blachy
DE Blechscherer
RU Ножницы по металлу
CZ Nůžky na plech
HU Lemezvágó olló

RO Foarfece pt. tablă
FR Cisaille à tôle
IT Cesioie per lamiera
ES Tijeras para chapas
CN 铁皮剪



HRC
58-61



YATO	L [mm]	Cutting length / Długość cięcia [mm]	Cooper / Miedz [mm]	Cold rolled steel / Stal zimnowalcowana [mm]	Steel HRC35 / Stal HRC35 [mm]	SS 304 / Stal nierdzewna 304 [mm]	
YT-1925	225	52	0.94	0.78	0.6	0.45	6/36

EN Tin snips
PL Nożyce do cięcia blachy
DE Blechscherer
RU Ножницы по металлу
CZ Nůžky na plech
HU Lemezvágó olló

RO Foarfece pt. tablă
FR Cisaille à tôle
IT Cesioie per lamiera
ES Tijeras para chapas
CN 铁皮剪

HRC
58-61



YATO	L [mm]	Cutting length / Długość cięcia [mm]	Cooper / Miedz [mm]	Cold rolled steel / Stal zimnowalcowana [mm]	Steel HRC35 / Stal HRC35 [mm]	SS 304 / Stal nierdzewna 304 [mm]	
YT-1924	254	52	0.94	0.78	0.6	0.45	6/36

EN Tin snips
PL Nożyce do cięcia blachy
DE Blechscherer
RU Ножницы по металлу
CZ Nůžky na plech
HU Lemezvágó olló

RO Foarfece pt. tablă
FR Cisaille à tôle
IT Cesioie per lamiera
ES Tijeras para chapas
CN 铁皮剪



HRC
58-60



YATO	L [mm]	Cutting length / Długość cięcia [mm]	Cooper / Miedz [mm]	Cold rolled steel / Stal zimnowalcowana [mm]	Steel HRC35 / Stal HRC35 [mm]	SS 304 / Stal nierdzewna 304 [mm]	
YT-1920	260	42	1.2	1.0	0.6	0.5	6/36

EN Tin snips
PL Nożyce do cięcia blachy
DE Blechscherer
RU Ножницы по металлу
CZ Nůžky na plech
HU Lemezvágó olló

RO Foarfece pt. tablă
FR Cisaille à tôle
IT Cesioie per lamiera
ES Tijeras para chapas
CN 铁皮剪

HRC
55-60

S55C

HIGH FREQUENCY
HARDENING
HARTONANIE
IMPULSOWE



YATO	L [mm]	Cutting length / Długość cięcia [mm]	Cooper / Miedz [mm]	Cold rolled steel / Stal zimnowalcowana [mm]	Steel HRC35 / Stal HRC35 [mm]	SS 304 / Stal nierdzewna 304 [mm]	
YT-1963	200	40	1.5	1.0	0.6	0.6	6/36
YT-1964	250	60	1.8	1.2	0.8	0.8	6/24
YT-1965	300	75	2.0	1.4	0.8	0.8	6/12

EN Metal sheet nibbler
 PL Nożyce matrycowe do blachy
 DE Blechnibbler
 RU Ножницы для резки жести
 CZ Nůžky na plech
 HU Lemezvágó olló
 RO Foarfece pt. tablă
 FR Grignoteuse a tole
 IT Cesovia rotitrice per lamiera
 ES Tijeras para chapas
 CN 法式剪

260 mm max 1.0 mm PLATE BLACHA max 1.2 mm Al max 2.0 mm PLASTIC PLASTIK 3.0 mm CHANGEABLE BLADES WYMIENNE OSTRZA



EN Spare blades for metal sheet nibbler
 PL Ostrza zapasowe do nożyc matrycowych
 DE Abbrechklngen für Blechnibbler
 RU Лезвия для ножиц для резки жести
 CZ Ostrí náhradní
 HU Tartalékpenge
 RO Lame de rezervă
 FR Lame sécables pour grignoteuse a tole
 IT Lame di ricambio per cesovia rotitrice per lamiera
 ES Cuchillas de recambio
 CN 法式剪备用刀片

3 PCS 65Mn



For YT-19260
 Dla YT-19260

YATO	L [mm]	
YT-19260	260	6/36

YATO	
YT-19261	10/100

EN Shears for cutting sheet metal
 PL Nożyce krawzkowe do cięcia blach
 DE Rollenblechscher
 RU Дикосовые ножницы для резки листового металла
 CZ Kotoúčové nůžky na stříhání plechů
 HU Karos lemezvágó olló
 RO Dispozitiv taiat foi de tabla
 FR Cisaille à tôle à molette
 IT Cesovia rotante per lamiera
 ES Cortador rotativo para chapa
 CN 手动钢板剪

120 mm



EN Steel strap cutter
 PL Nożyce do cięcia taśmy stalowej
 DE Stahlgurtblechscher
 RU Ножницы для резки стальной ленты
 CZ Nůžky na plech
 HU Lemezvágó olló

HRC 58-61



YATO	L [mm]	Cold rolled steel / Stal zimnowalcowana [mm]	Stainless steel / Stal nierdzwerna [mm]	Aluminium [mm]	
YT-18950	120	1.6	1.2	2.0	1

YATO	L [mm]	Cutting length / Długość cięcia [mm]	Steel HRC35 / Stal HRC35 [mm]	SS 304 / Stal nierdzwerna 304 [mm]	
YT-1930	305	28	0.8	0.6	6/24

EN Bolt cutter
 PL Nożyce do drutu
 DE Drahtschere
 RU Болторез
 CZ Nůžky na drát
 HU Drótvágó olló
 RO Cleste pt. buloane
 FR Ciseaux à fil
 IT Cesioie tagliafilii
 ES Tijeras para alambre
 CN 断线钳



200 mm max Ø 3.5 mm CrV

YATO	L [mm]	max. Ø [mm]	
YT-18566	200	3.5	6/48

EN Bolt cutter
 PL Nożyce do prętów
 DE Bolzenschneider
 RU Болторез
 CZ Nůžky na tyče
 HU Drótvágó olló

RO Cleste pt. buloane
 FR Coupe-boulon
 IT Tagliabulloni
 ES Cortavarillas
 CN 断线钳

HRC 56-61 CrMo



EN Bolt cutter
 PL Nożyce do prętów
 DE Bolzenschneider
 RU Болторез
 CZ Nůžky na tyče
 HU Drótvágó olló

RO Cleste pt. buloane
 FR Coupe-boulon
 IT Tagliabulloni
 ES Cortavarillas
 CN 断线钳

CrMo



YATO	L [mm]	Size / Rozmiar	max. Ø soft / maks. Ø miękki [mm]	max. Ø medium / maks. Ø średnio twardy [mm]	
YT-1843	300	12"	5	4	20
YT-1844	350	14"	7	5	10
YT-1845	450	18"	8	6	10
YT-1846	600	24"	10	8	6
YT-1847	750	30"	13	10	4
YT-1848	900	36"	16	12	3

YATO	L [mm]	Size / Rozmiar	max. Ø [mm]	
YT-1851	350	14"	6	6/24
YT-1852	450	18"	7	6/12
YT-1853	600	24"	10	2/12
YT-1854	750	30"	12	6
YT-1855	900	36"	14	4
YT-1856	1050	42"	16	2

EN Concrete mesh cutter
 PL Nożyce do siatki zbrojarskiej
 DE Mattenschneider
 RU Ножницы для резки арматурной сетки
 CZ Pákové kleště na pletivo
 HU Gyékényvágó
 RO Cleste pt. fier beton
 FR Coupe-trellis
 IT Cesioie per reti di rinforzo
 ES Cortante para varillas de encofrado
 CN 鹰嘴断线钳

800 mm max Ø 11 mm CrV



YATO	L [mm]	
YT-18400	800	5

EN Wire rope cutter
 PL Nożyce do drutu i linek stalowych
 DE Kabel- und Drahtseilschere
 RU Ножницы арматурные
 CZ Štípací kleště na dráty a ocelová lanka
 HU Drótkötél vágó olló
 RO Dispozitiv de tăiat frânghie
 FR Pince coupante pour fils et câbles métalliques
 IT Cesioie per fil di ferro e funi di acciaio
 ES Tijeras para alambre y cables de acero
 CN 钢丝绳剪

190 mm max Ø 1.5 mm max Ø 4 mm HRC 58-62 CrV



YATO	Wire max. cutting diameter / Maks. średnica cięcia drutu [mm]	Steel line max. cutting diameter / Maks. średnica cięcia linki stalowej [mm]	
YT-18570	1.5	4	10/60

- EN Hydraulic cutter
PL Ręczny obcinak hydrauliczny
DE Manueller Hydraulikschneider
RU Ручной гидравлический резак
- CZ Rucní hydraulický odřezávac
HU Kézi hidraulikus betonacélvágó
RO Cuiț pt. rețezat tevi
FR Coupe manuelle hydraulique
- IT Cesovia idraulica manuale
ES Cortadora hidráulica manual
CN 液壓剪

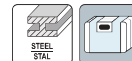

∅ 4-12 mm 320 mm 6t

YATO	Cutting diameter / Średnica cięcia [mm²]	L [mm]	Force pressure / Siła nacisku [t]	
YT-22870	4-12	320	6	5
YATO	Cutting diameter / Średnica cięcia [mm²]	L [mm]	Force pressure / Siła nacisku [t]	
YT-22871	4-16	430	8	5
YT-22872	4-20	515	13	3

- EN Heads for hydraulic cutter
PL Noże wymienne do obcinaka hydraulicznego
DE Austauschmesser für Hydraulikschneider
RU Сменные ножи для гидравлического резака
CZ Výměnitelné nože do hydraulického odřezávac
HU Cserekes a hidraulikus betonacélvágóhoz
RO Cutter hidraulic pt. cabluri
FR Lame pour coupe manuelle hydraulique
IT Teste per coltelli idraulici
ES Cuchillas intercambiables para cortadora hidráulica
CN 液壓鉗鉗口配件



2 PCS

YATO	Size / Rozmiar [mm]	For / Dla	
YT-22873	12	YT-22870	10/100
YT-22874	16	YT-22871	10/100
YT-22875	20	YT-22872	10/100

- EN Hydraulic metal hole puncher
PL Wycinak hydrauliczny otworów w blachach
DE Hydraulischer Blechlocher
RU Инструмент для просекания отверстий гидравлический ручной
CZ Hydraulický vysekávač otvorů v plechu
HU Hidraulikus lemezlyukasztó
RO Perforator hidraulic metalic
FR Emporte-pièce hydraulique à tôle
IT Punzonatrice idraulica per lamiera
ES Cortador hidráulico de agujeros en hojas de chapa
CN 液壓開孔器



∅ 22-60 mm

6t

max 3mm

360°



YATO	Cutting diameter / Średnica cięcia [mm]	Force pressure / Siła nacisku [t]	
YT-18900	22-60	6	2

- EN Hydraulic metal hole puncher
PL Wycinak hydrauliczny otworów w blachach
DE Hydraulischer Blechlocher
RU Инструмент для просекания отверстий гидравлический ручной
CZ Hydraulický vysekávač otvorů v plechu
HU Hidraulikus lemezlyukasztó
RO Perforator hidraulic metalic
FR Emporte-pièce hydraulique à tôle
IT Punzonatrice idraulica per lamiera
ES Cortador hidráulico de agujeros en hojas de chapa
CN 液壓開孔器



∅ 22-60 mm

6t

max 4mm



YATO	Cutting diameter / Średnica cięcia [mm]	Force pressure / Siła nacisku [t]	
YT-18907	22-60	6	1

EN Multi-function scissors
 PL Nożyce wielofunkcyjne
 DE Multifunktionsmesser
 RU Ножницы многофункциональные
 CZ Všeúčelové nůžky
 HU Többfunkciós olló
 RO Foarfece multifuncțional
 FR Cisailles universelle
 IT Cesioie multifunzione
 ES Tijeras multifuncionales
 CN 不锈钢多用剪

65/200 mm
 HRC 50-54
 3Cr13



YATO	L [mm]	
YT-1976	200	12/72

EN Multi-function slot angle scissors - professional
 PL Nożyce do cięć kątowych (ukośnych)
 DE Winkelschere (schräg)
 RU Ножницы для резы под углом (по диагонали)
 CZ Nůžky pro šikmé stříhání
 HU Gérvágó olló
 RO Foarfece cu unghi de slot multifuncțional - profesional
 FR Cisailles d'angle
 IT Forbici per tagli angolari (diagonali)
 ES Tijera de inglete
 CN 角度剪

245 mm
 ± 22.5°
 ± 45°
 ± 90°
 SS
 STAINLESS STEEL
 STYL NERZEWA
 AI



YATO	L [mm]	
YT-18960	245	4/24

EN HD multifunctional scissors
 PL Nożyce techniczne wielofunkcyjne
 DE Multifunktionale technische Schere
 RU Технические многофункциональные ножницы
 CZ Multifunkční technické nůžky
 HU Műszaki olló - multifunkciós
 RO Foarfece multifuncționala HD
 FR Cisailles polyvalentes
 IT Cesioie tecniche multifunzione
 ES Tijera técnica multiusos
 CN 剪刀

250 mm
 SK5
 Cr12Mo



YATO	L [mm]	
YT-18963	250	6/24

EN Hand saw for wood
 PL Pila płatkina do drewna
 DE Handsäge für Holz
 RU Ручная пила по дереву
 CZ Ruční pila na dřevo
 HU Rókafarkú fűrész
 RO Fierastrău „coada de vulpe” pt. lemn
 FR Scie égoïne à bois
 IT Segaccio per legno
 ES Serrucho para carpintero
 CN 手板锯

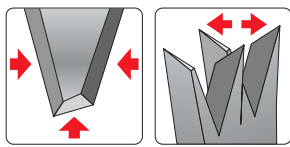

7TPI
 1.6mm
 0.9mm
 HRC 50-54
 65Mn



YATO	L [mm]	
YT-3101	400	12/48
YT-3102	450	10/40
YT-3103	500	10/40

EN Hand saw for wood
 PL Pila płatkina do drewna
 DE Handsäge für Holz
 RU Ручная пила по дереву
 CZ Ruční pila na dřevo
 HU Rókafarkú fűrész
 RO Fierastrău „coada de vulpe” pt. lemn
 FR Scie égoïne à bois
 IT Segaccio per legno
 ES Serrucho para carpintero
 CN 手板锯

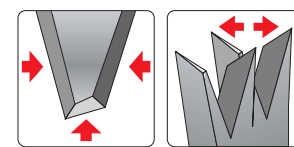

7TPI
 1.6mm
 0.9mm
 HRC 50-54
 PTFE
 65Mn



YATO	L [mm]	
YT-3106	400	12/48
YT-3107	450	10/40
YT-3108	500	10/40

EN Hand saw for wood
 PL Pila płatkina do drewna
 DE Handsäge für Holz
 RU Ручная пила по дереву
 CZ Ruční pila na dřevo
 HU Rókafarkú fűrész

RO Fierastrău „coada de vulpe” pt. lemn
 FR Scie égoïne à bois
 IT Segaccio per legno
 ES Serrucho para carpintero
 CN 手板锯

7TPI
 1.6mm
 0.9mm
 PTFE
 65Mn

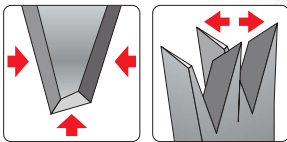

YATO	L [mm]	
YT-31091	400	6/24
YT-31092	450	6/24
YT-31093	500	6/24

EN Hand saw for wood
 PL Pila płatkina do drewna
 DE Handsäge für Holz
 RU Ручная пила по дереву
 CZ Ruční pila na dřevo
 HU Rókafarkú fűrész

RO Fierastrău „coada de vulpe” pt. lemn
 FR Scie égoïne à bois
 IT Segaccio per legno
 ES Serrucho para carpintero
 CN 手板锯

7TPI
 65Mn
 PTFE

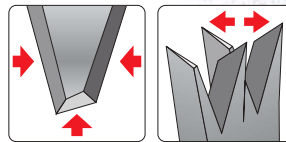

YATO	L [mm]	
YT-31095	350	12/48
YT-31096	400	12/48
YT-31097	450	12/48

EN Back saw for PVC
 PL Pila ręczna do PVC
 DE Handsäge für PVC
 RU Ручная пила для ПВХ
 CZ Ruční pila na PVC
 HU Kézifűrész PVC-hez

RO Fierastrău cu maner PVC
 FR Scie à main pour PVC
 IT Sega a mano per PVC
 ES Sierra de mano para PVC
 CN 锯

PVC
 350/440 mm
 17 TPI
 65Mn



YATO	L [mm]	
YT-31303	440	12/48

EN Japanese saw
 PL Pila japońska
 DE Japanische Handsäge
 RU Ножовка японского типа
 CZ Japonská ruka pila
 HU Japán fűrész

RO Ferăstrău de gips-carton
 FR Scie japonaise
 IT Sega reversibile giapponese
 ES Sierra japonesa
 CN 双面齿拉锯

320/660 mm
 7TPI
 12 TPI
 SK5



YATO	L [mm]	
YT-31310	660	10/40

EN Drywall saw
PL Pila dwustronna do płyt gipsowo-kartonowych
DE Gipskartonsäge
RU Ножовка по гипсокартону

CZ Pila na sádrokarton
HU Gipszkarton fűrész
RO Kézi gipszkarton fűrész
FR Scie à guichet

IT Sega per pannelli in cartongesso
ES Serrucho para placas de yeso
CN 墙板锯



180/315
mm

7TPI

65Mn



YATO

YT-31343

L [mm]

315



12/96

EN Saw with adjustable handle
PL Pila z przestawianą rękojeścią
DE Säge mit verstellbarem Griff
RU Пила с регулируемой ручкой
CZ Pila s nastaviteľnou rukojeťou
HU Fűrész állítható markolattal

RO Fierastrau cu maner reglabil
FR Scie à poignée réglable
IT Sega con maniglia regolabile
ES Sierra con mango móvil
CN 调节锯

250/410
mm

12
TPI

0.6 mm

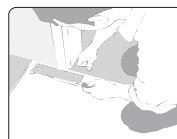

YATO

YT-31290

L [mm]

410



6/48

EN Compass saw
PL Pila otwornica
DE Stichsäge

RU Выкружная пила
CZ Pila otvornice
HU Lyukfűrész

RO Ferăstrău coadă de șoarece
FR Scie étroite
IT Sega a foretto

ES Serrucho de punta
CN 鸡尾锯

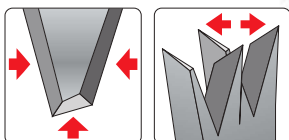

YATO

YT-3133

L [mm]

300



12/60

300
mm

7TPI



HRC
50-54

65Mn



EN Wallboard saw
PL Pila do gipsów
DE Gipsäge

RU Ножовка по гипсокартону
CZ Pila na sádro
HU Gipszfűrész

RO Ferăstrău pt. ghips
FR Scie pour plaques de plâtre
IT Sega per cartongesso

ES Serrucho para cartón yeso
CN 墙板锯

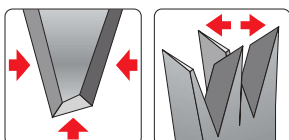

YATO

YT-3134

L [mm]

300



12/60

160/300
mm

7TPI



HRC
50-54

65Mn



EN Plastic miter box with dovetail saw
PL Plastikowa skrzynka uciosowa z piłą
DE Kunststoffschneidladen mit Säge
RU Ступено пластмассовое с пилой
CZ Přípravek na řezání úhlu s pilkou
HU Gérvágóg műanyagláda hód farkú fűrészszel
RO Fierastrau cu dispozitiv de taiat la unghi
FR Boîte à onglets + scie
IT Taglia cornici in plastica con sega
ES Guía de ingletar y sierra
CN 燕尾锯

350
mm

12
TPI

1.2 mm
0.8 mm

HRC
50-54

65Mn

300x140
x70
mm

ABS



YATO

YT-3150

L [mm]

350



10

EN Bow saw
PL Pila kablakowa
DE Bügelsäge
RU Лучковая пила
CZ Oblouková pila
HU Keretes fűrész

RO Ferăstrău de curbură
FR Scie à bûches
IT Sega ad arco
ES Sierra de arco
CN 两用弓锯

HCS65



YATO

YT-3200

L [mm]

300



12/24



YATO

YT-3201

L [mm]

450



12/24

YT-3202

530

12/24

YT-3203

610

12/24

YT-3204

760

12/24

EN Bow saw blade for dry wood
 PL Brzeczczot do drewna suchego
 DE Bügelsägeblatt für trockenes Holz
 RU Полотно для лучковой пилы по сухому дереву
 CZ Pilový list na suché dřevo
 HU Keretes fűrészhez fűrészlap száraz fához

RO Lamă pt. lemn uscat
 FR Lame pour bois sec
 IT Lama per legno secco
 ES Hoja de sierra para madera seca
 CN 干木锯条



EN Bow saw blade for wet wood
 PL Brzeczczot do drewna mokrego
 DE Bügelsägeblatt für frisches Holz
 RU Полотно для лучковой пилы по влажному дереву
 CZ Pilový list na mokré dřevo
 HU Keretes fűrészhez fűrészlap nedves fához

RO Lamă pt. lemn verde
 FR Lame pour bois humide
 IT Lama per legno bagnato
 ES Hoja de sierra para madera húmeda
 CN 湿木锯条



YATO	L [mm]	
YT-3221	450	50/200
YT-3222	530	50/200
YT-3223	610	50/200
YT-3224	760	50/200

YATO	L [mm]	
YT-3230	300	50/200
YT-3231	450	50/200
YT-3232	530	50/200
YT-3233	610	50/200
YT-3234	760	50/200

EN Hacksaw frame
 PL Pila do metalu
 DE Metallbogensäge
 RU Пила по металлу

CZ Pílka na železo
 HU Fémfűrész
 RO Ferăstrău cu cadru metalic
 FR Scie à métal

IT Seghetto per metallo
 ES Sierra de metalo
 CN 锯架



YATO	L [mm]	
YT-3160	300	10

YATO	L [mm]	
YT-3161	300	6/36

YATO	L [mm]	
YT-3163	300	5/20

EN Metal hacksaw
 PL Pila do metalu
 DE Metallsäge
 RU Ножовка по металлу
 CZ Pila na kov
 HU Fémfűrész
 RO Ferăstrău metalic
 FR Scie à métaux
 IT Seghetto per metallo
 ES Sierra para metales
 CN 金属钢锯

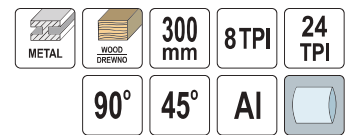

YATO	L [mm]	
YT-31612	300	12/36

EN Hacksaw frame blade
 PL Brzeczczot do metalu
 DE Metallsägeblatt
 RU Полотно по металлу

CZ Pilový list na kovy
 HU Fémfűrész lap
 RO Panza fierastrau pt. metal
 FR Lame à métal

IT Lama per metallo
 ES Hoja de sierra para metalo
 CN 弹性锯条



YATO	L [mm]	W [mm]	TPI	pcs / szt.	
YT-3460	300	12	24	5	10/200



YATO	L [mm]	W [mm]	TPI	pcs / szt.	
YT-3461	300	12	24	2	20/500

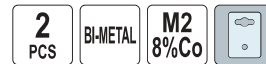

YATO	L [mm]	W [mm]	TPI	pcs / szt.	
YT-3462	300	12	24	2	20/500

EN Band saw blade
 PL Brzeczczot do pily taśmowej
 DE Bandsägeblätter
 RU Полотно для ленточной пилы
 CZ Pilový pás na pásovou pilu
 HU Szalagfűrészlap
 RO Panza pt. fierastrau cu banda
 FR Lame de scie à ruban
 IT Lama per sega a nastro
 ES Hoja de sierra de cinta
 CN 带锯锯条

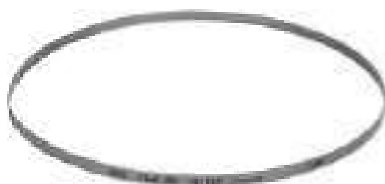
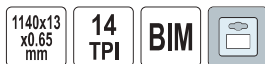

For YT-82185
 Dla YT-82185

YATO	L [mm]	W [mm]	TPI	
YT-82189	1140	0.65	14	20

EN Jig saw blades
 PL Brzeczczoty do wyrzynarki
 DE Stichsägeblätter
 RU Полотно для пневматической сабельной пилы
 CZ Pilový list do přímochaře pily
 HU Dekopírlap

RO Set panze pt. fierăstrău sabie
 FR Lame pour scie sauteuse
 IT Lama per seghetti pneumatici
 ES Recambio sierra de calar
 CN 锯片



For YT-09955
 Dla YT-09955

YATO	TPI	
YT-09958	24	50/200
YT-09959	32	50/200

EN Sabre saw blade
PL Brzeszczot do cegieł i pustaków
DE Säbelsägeblatt
RU Пильное полотно

CZ Pílový plátek do pily ocasky
HU Szablyafűrészlap
RO Pânză pt. fierăstrău sabie
FR Lames scie sabre

IT Lama per mattoni e mattoni cavi
ES Hoja de sierra sable
CN 硬质合金锯条



YATO	L [mm]	
YT-33951	300	20/100
YT-33950	455	25/100

EN Sabre saw blade
PL Brzeszczot do pily szablastej
DE Säbelsägeblatt
RU Пильное полотно
CZ Pílový plátek do pily ocasky
HU Szablyafűrészlap

RO Pânză pt. fierăstrău sabie
FR Lames scie sabre
IT Lama per sega a lama oscillante
ES Hoja de sierra sable
CN 碳钢往复锯条



YATO	L [mm]	+/- [mm]	TPI	
YT-33920	300	1.45	5	50/100



YATO	L [mm]	+/- [mm]	TPI	
YT-33921	150	1.2	4	50/200
YT-33922	150	1.0	6	50/200
YT-33923	150	1.0	8	50/200

YATO	L [mm]	+/- [mm]	TPI	
YT-33930	150	1.0	10	50/200

YATO	L [mm]	+/- [mm]	TPI	
YT-33931	150	1.0	18	50/200
YT-33932	150	1.0	24	50/200



YATO	L [mm]	+/- [mm]	TPI	
YT-33933	225	1.0	10	50/200
YT-33934	225	1.0	24	50/200
YT-33935	300	1.25	6	50/100

EN Sabre saw blade
PL Brzeszczot do pily szablastej
DE Säbelsägeblatt
RU Пильное полотно
CZ Pílový plátek do pily ocasky
HU Szablyafűrészlap

RO Lamă fierăstrău sabie
FR Lame de scie sabre
IT Lama per sega a gattuccio
ES Hoja de sierra sable
CN 往复锯条

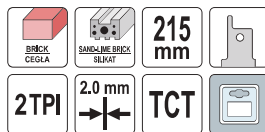

YATO	L [mm]	+/- [mm]	TPI	
YT-33960	215	2.0	2	100/200

EN Sabre saw blade
PL Brzeszczot do pily szablastej
DE Säbelsägeblatt
RU Пильное полотно
CZ Pílový plátek do pily ocasky
HU Szablyafűrészlap

RO Lamă fierăstrău sabie
FR Lame de scie sabre
IT Lama per sega a gattuccio
ES Hoja de sierra sable
CN 往复锯条



YATO	L [mm]	+/- [mm]	TPI	
YT-33961	462	2.0	1	25/50

EN Sabre saw blade
PL Brzeszczot do pily szablastej
DE Säbelsägeblatt
RU Пильное полотно
CZ Pílový plátek do pily ocasky
HU Szablyafűrészlap
RO Lamă fierăstrău sabie
FR Lame de scie sabre
IT Lama per sega a gattuccio
ES Hoja de sierra sable
CN 往复锯条



• For straight cuts
• Doesn't bend when cuts
• Do cięć na wprost
• Nie wygina się podczas cięcia

For YT-82281, YT-82814, YT-82815, YT-82904
Dla YT-82281, YT-82814, YT-82815, YT-82904

YATO	L [mm]	+/- [mm]	TPI	
YT-33970	230	1.0	12	10/80

EN Sabre saw blade
PL Brzeszczot do pily szablastej
DE Säbelsägeblatt
RU Пильное полотно
CZ Pílový plátek do pily ocasky
HU Szablyafűrészlap
RO Lamă fierăstrău sabie
FR Lame de scie sabre
IT Lama per sega a gattuccio
ES Hoja de sierra sable
CN 往复锯条



• For straight cuts
• Doesn't bend when cuts
• Do cięć na wprost
• Nie wygina się podczas cięcia

For YT-82281, YT-82814, YT-82815, YT-82904
Dla YT-82281, YT-82814, YT-82815, YT-82904

YATO	L [mm]	+/- [mm]	TPI	
YT-33971	230	1.2	6	10/100

EN Sabre saw blade
 PL Brzeczczot do pily szablastej
 DE Säbelsägeblatt
 RU Пильное полотно
 CZ Pílkový plátek do pily oscacky
 HU Szablyafűrészlap

RO Lamă fierăstrău sabie
 FR Lame de scie sabre
 IT Lama per sega a gattuccio
 ES Hoja de sierra sable
 CN 往复锯条



For YT-82281, YT-82814, YT-82815, YT-82904
 Dla YT-82281, YT-82814, YT-82815, YT-82904

• For plunge and curve cuts
 • Do cięć wglębnych i po łuku

YATO	L [mm]	↔ [mm]	TPI	
YT-33972	120	1.2	12	10/100

EN Jig saw blades
 PL Brzeczczoty do wryznarki
 DE Stichsägeblätter

RU Полотно для электр. станка
 CZ Pílkový list do přimočaré pily
 HU Dekopírfap

RO Lama fierăstrău pendular
 FR Lames à scie sauteuse
 IT Scalpelli per il seghetto

ES Recambio sierra de calar
 CN 曲线锯条

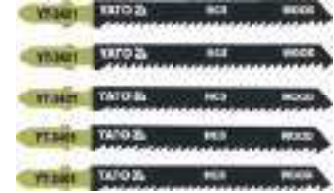
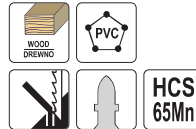
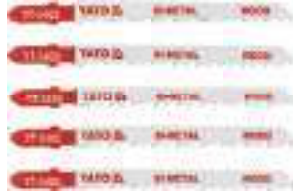
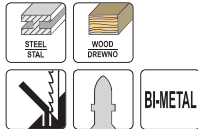

YATO	L [mm]	Working length / Długość robocza [mm]	↔ [mm]	TPI	
YT-3400	100	75	1.27	6	50/250

YATO	L [mm]	Working length / Długość robocza [mm]	↔ [mm]	TPI	
YT-3401	100	75	1.3	10	50/250



YATO	L [mm]	Working length / Długość robocza [mm]	↔ [mm]	TPI	
YT-3402	100	75	1.2	8	50/250

YATO	L [mm]	Working length / Długość robocza [mm]	↔ [mm]	TPI	
YT-3403	100	75	1.3	6	50/250



YATO	L [mm]	Working length / Długość robocza [mm]	↔ [mm]	TPI	
YT-3404	100	75	1.3	10	50/250

YATO	L [mm]	Working length / Długość robocza [mm]	↔ [mm]	TPI	
YT-3405	100	75	1.3	6	50/250



YATO	L [mm]	Working length / Długość robocza [mm]	↔ [mm]	TPI	
YT-3407	75	50	1.0	13	50/250

YATO	L [mm]	Working length / Długość robocza [mm]	↔ [mm]	TPI	
YT-3408	115	90	1.3	13-8	50/250

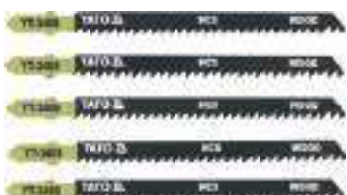

YATO	L [mm]	Working length / Długość robocza [mm]	↔ [mm]	TPI	
YT-3409	115	90	1.3	8	50/250

YATO	L [mm]	Working length / Długość robocza [mm]	↔ [mm]	TPI	
YT-3410	100	75	1.4	6	50/250

EN Jig saw blades
PL Brzeszczyoty do wyrzynarki
DE Stichsägeblätter

RU Полотно для электр. станка
CZ Pilový list do přimočaré pily
HU Dekopírlap

RO Lama fierastrau pendular
FR Lames à scie sauteuse
IT Scalpelli per il seghetto

ES Recambio sierra de calar
CN 曲线锯条

5
PCS

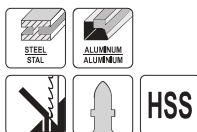

YATO	L [mm]	Working length / Długość robocza [mm]	+/- [mm]	TPI	Box
YT-3411	100	75	1.0	8	25/250

YATO	L [mm]	Working length / Długość robocza [mm]	+/- [mm]	TPI	Box
YT-3412	75	50	1.0	21	25/250



YATO	L [mm]	Working length / Długość robocza [mm]	+/- [mm]	TPI	Box
YT-3413	75	50	1.0	12	25/250

YATO	L [mm]	Working length / Długość robocza [mm]	+/- [mm]	TPI	Box
YT-3414	75	50	1.0	32	25/250

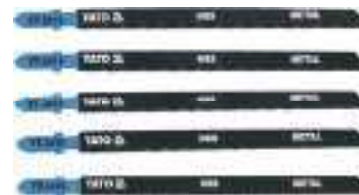
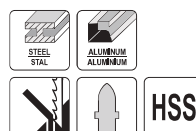
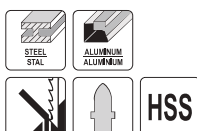

YATO	L [mm]	Working length / Długość robocza [mm]	+/- [mm]	TPI	Box
YT-3415	100	75	1.0	24-10	25/250

YATO	L [mm]	Working length / Długość robocza [mm]	+/- [mm]	TPI	Box
YT-3416	130	106	1.0	21	25/250

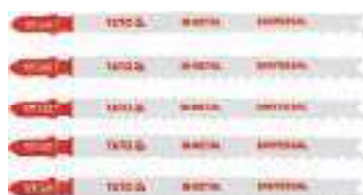

YATO	L [mm]	Working length / Długość robocza [mm]	+/- [mm]	TPI	Box
YT-3417	130	106	1.27	10-5	25/250

YATO	L [mm]	Working length / Długość robocza [mm]	+/- [mm]	TPI	Box
YT-3421	75	50	1.2	25/250	

EN Jig saw blades
PL Brzeszczyoty do wyrzynarki
DE Stichsägeblätter
RU Пилки для лобзика
CZ Pilový list do přimočaré pily
HU Dekopírlap
RO Lama fierastrau pendular
FR Lames à scie sauteuse
IT Scalpelli per il seghetto
ES Recambio sierra de calar
CN 曲线锯条组套

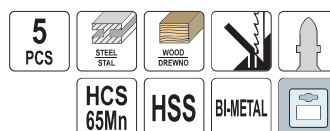

YATO	L [mm]	Working length / Długość robocza [mm]	+/- [mm]	TPI	Box
YT-3445	100, 100, 100, 75, 75	75, 75, 75, 50, 57	1.3, 1.3, 1.27, 1.0, 1.0	10, 6, 10, 32, 12	25/250

EN Half-moon saw blade for oscillating multitool HSS
 PL Brzeszczot okrągły HSS do narzędzia wielofunkcyjnego
 DE Rundes Sägeblatt HSS für Multifunktionswerkzeug
 RU Диское полотно HSS для многофункционального инструмента
 CZ Segmentový pilový list HSS pro multifunkční nářadí
 HU HSS kör keresztmetszetű fűrészlap multifunkciós szerszámhoz
 RO Lamă rotundă HSS pt. unealta multifuncțională
 FR Lame segment HSS pour outil multifonction
 IT Lama di sega circolare per lo strumento multi-funzione HSS
 ES Hoja redonda HSS para herramienta multifuncional
 CN 半圆形摆动锯

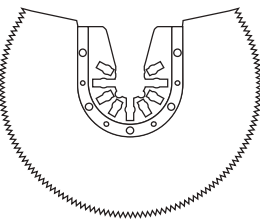
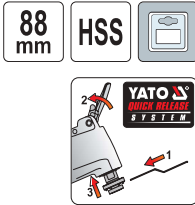

88 mm

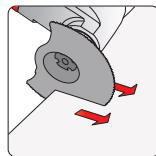

• Application: wood, plastic, soft metal, plaster
 • Zastosowanie: drewno, plastik, miękki metal, gips
 For YT-82220, YT-82223, YT-82818, YT-82900
 Dla YT-82220, YT-82223, YT-82818, YT-82900

YATO **YT-34680** 5/100

EN Half-moon saw blade for oscillating multitool HCS
 PL Brzeszczot okrągły HCS do narzędzia wielofunkcyjnego
 DE Rundes Sägeblatt HCS für Multifunktionswerkzeug
 RU Диское полотно HCS для многофункционального инструмента
 CZ Segmentový pilový list HCS pro multifunkční nářadí
 HU HCS kör keresztmetszetű fűrészlap multifunkciós szerszámhoz
 RO Lamă rotundă HCS pt. unealta multifuncțională
 FR Lame segment HCS pour outil multifonction
 IT Lama di sega circolare per lo strumento multi-funzione HCS
 ES Hoja redonda HCS para herramienta multifuncional
 CN 高碳钢扇型锯片

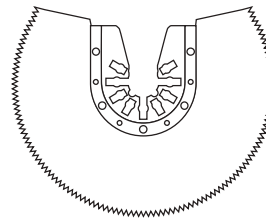
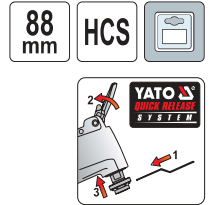

88 mm

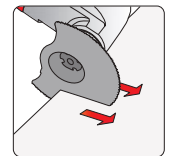

• Application: wood, plastic, soft metal, plaster
 • Zastosowanie: drewno, plastik, miękki metal, gips
 For YT-82220, YT-82223, YT-82818, YT-82900
 Dla YT-82220, YT-82223, YT-82818, YT-82900

YATO **YT-34681** 5/100

EN Brazed carbide d-shape blade for oscillating multitool HM
 PL Brzeszczot okrągły HM do narzędzia wielofunkcyjnego
 DE Rundes Sägeblatt HM für Multifunktionswerkzeug
 RU Диское полотно HM для многофункционального инструмента
 CZ Segmentový pilový list HM pro multifunkční nářadí
 HU HM kör keresztmetszetű fűrészlap multifunkciós szerszámhoz
 RO Lamă rotundă HM pt. unealta multifuncțională
 FR Lame segment HM pour outil multifonction
 IT Lama di sega circolare per lo strumento multi-funzione HM
 ES Hoja redonda HM para herramienta multifuncional
 CN 摆动锯

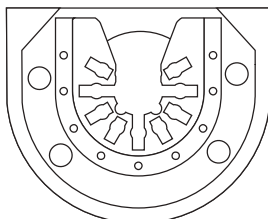
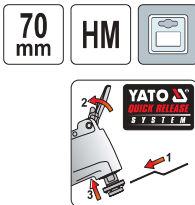

70 mm

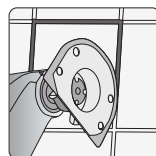

• Application: concrete, ceramic materials, epoxy resin, fibreglass
 • Zastosowanie: beton, materiały ceramiczne, żywica epoksydowa, włókno szklane
 For YT-82220, YT-82223, YT-82818, YT-82900
 Dla YT-82220, YT-82223, YT-82818, YT-82900

YATO **YT-34682** 10/100

EN Half-moon saw blade for oscillating multitool BIM
 PL Brzeszczot półokrągły BIM do narzędzia wielofunkcyjnego
 DE Rundes Sägeblatt BIM für Multifunktionswerkzeug
 RU Диское полотно BIM для многофункционального инструмента
 CZ Segmentový pilový list BIM pro multifunkční nářadí
 HU BIM kör keresztmetszetű fűrészlap multifunkciós szerszámhoz
 RO Lamă rotundă BIM pt. unealta multifuncțională
 FR Lame segment BIM pour outils multifonctions
 IT Lama di sega circolare per lo strumento multi-funzione BIM
 ES Hoja redonda BIM para herramienta multifuncional
 CN 多功能锯片

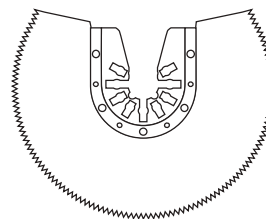
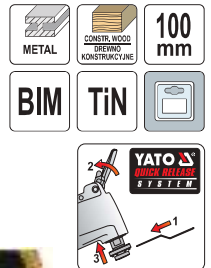

100 mm

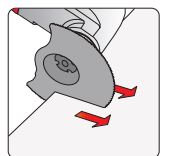

• Application: wood, metal
 • Zastosowanie: drewno, metal
 For YT-82220
 Dla YT-82220

YATO **YT-34711** 10/100

EN Half-moon saw blade for oscillating multitool BIM
 PL Brzeczczot półokrągły BIM do narzędzia wielofunkcyjnego
 DE Rundes Sägeblatt BIM für Multifunktionswerkzeug
 RU Дискоевое полотно BIM для многофункционального инструмента
 CZ Segmentový pilový list BIM pro multifunkční nářadí
 HU BIM kör keresztmetszetű fűrészlap multifunkciós szerszámozhoz
 RO Lamă rotundă BIM pt. unealta multifuncțională
 FR Lame segment BIM pour outils multifonctions
 IT Lama di sega circolare per lo strumento multi-funzione BIM
 ES Hoja redonda BIM para herramienta multifuncional
 CN 多功能锯片

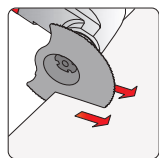
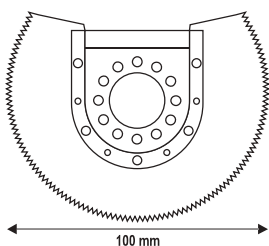
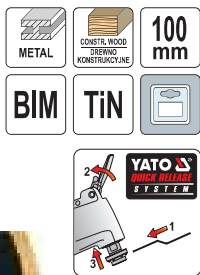

• Application: wood, metal
 • Zastosowanie: drewno, metal

For YT-82223
 Dla YT-82223

YATO  
 YT-34701 10/100

EN Plunge cutting saw blade for oscillating multitool BIM
 PL Brzeczczot wgłębny BIM do narzędzia wielofunkcyjnego
 DE Tiefenmesser BIM für Multifunktionswerkzeug
 RU Сабельное полотно BIM для многофункционального инструмента
 CZ Pilový list BIM na ponorné řezy pro multifunkční nářadí
 HU BIM merülő fűrészlap multifunkciós szerszámozhoz
 RO Lamă de adâncime BIM pt. unealta multifuncțională
 FR Lame scie plongeante BIM pour outil multifonction
 IT Lama per tagli dal pieno BIM
 ES Hoja para cortes profundos BIM para herramienta multifuncional
 CN 锯片

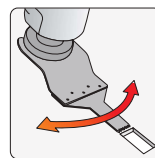
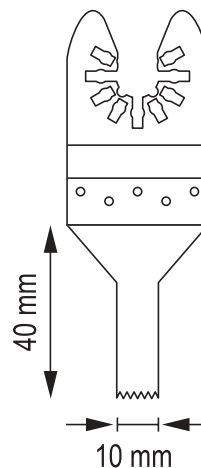
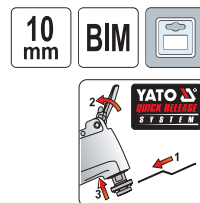

• Application: wood, plastic, metal, plaster, epoxy resin
 • Zastosowanie: drewno, plastik, metal, gips, żywica epoksydowa

For YT-82220, YT-82223, YT-82818, YT-82900
 Dla YT-82220, YT-82223, YT-82818, YT-82900

YATO  
 YT-34683 5/100

EN Plunge cutting saw blade for oscillating multitool BIM
 PL Brzeczczot wgłębny BIM do narzędzia wielofunkcyjnego
 DE Tiefenmesser BIM für Multifunktionswerkzeug
 RU Сабельное полотно BIM для многофункционального инструмента
 CZ Pilový list BIM na ponorné řezy pro multifunkční nářadí
 HU BIM merülő fűrészlap multifunkciós szerszámozhoz
 RO Lamă de adâncime BIM pt. unealta multifuncțională
 FR Lame scie plongeante BIM pour outil multifonction
 IT Lama per tagli dal pieno BIM
 ES Hoja para cortes profundos BIM para herramienta multifuncional
 CN 锯片

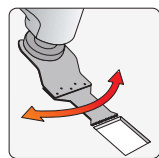
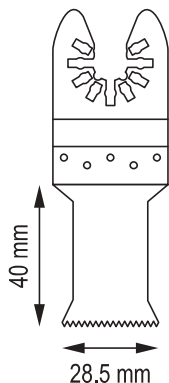
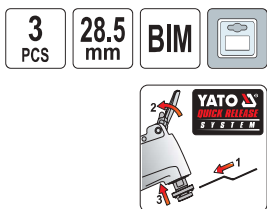

• Application: wood, plastic, metal, plaster, epoxy resin
 • Zastosowanie: drewno, plastik, metal, gips, żywica epoksydowa

For YT-82220, YT-82223, YT-82818, YT-82900
 Dla YT-82220, YT-82223, YT-82818, YT-82900

YATO  
 YT-34684 5/100

EN Plunge cutting saw blade for oscillating multitool HCS
 PL Brzeczczot wgłębny HCS do narzędzia wielofunkcyjnego
 DE Tiefenmesser HCS für Multifunktionswerkzeug
 RU Сабельное полотно HCS для многофункционального инструмента
 CZ Pilový list HCS na ponorné řezy pro multifunkční nářadí
 HU HCS merülő fűrészlap multifunkciós szerszámozhoz
 RO Lamă de adâncime HCS pt. unealta multifuncțională
 FR Lame scie plongeante HCS pour outil multifonction
 IT Lama per tagli dal pieno HCS
 ES Hoja para cortes profundos HCS para herramienta multifuncional
 CN 锯片

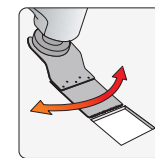
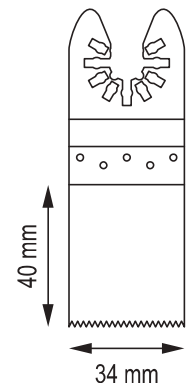
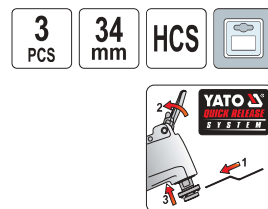

• Application: wood, plastic, plaster
 • Zastosowanie: drewno, plastik, gips

For YT-82220, YT-82223, YT-82818, YT-82900
 Dla YT-82220, YT-82223, YT-82818, YT-82900

YATO  
 YT-34685 10/100

EN Plunge cutting saw blade for oscillating multitool BIM
 PL Brzeszczot wgłębny BIM do narzędzia wielofunkcyjnego
 DE Tiefenmesser BIM für Multifunktionswerkzeug
 RU Сабельное полотно BIM для многофункционального инструмента
 CZ Pilový list BIM na ponorné řezy pro multifunkční nářadí
 HU BIM merülő fűrészlap multifunkciós szerszámozhoz
 RO Lamă de adâncime BIM pt. unealta multifuncțională
 FR Lame scie plongeante BIM pour outils multifonctions
 IT Lama per tagli dal pieno BIM
 ES Hoja para cortes profundos BIM para herramienta multifuncional
 CN 锯片

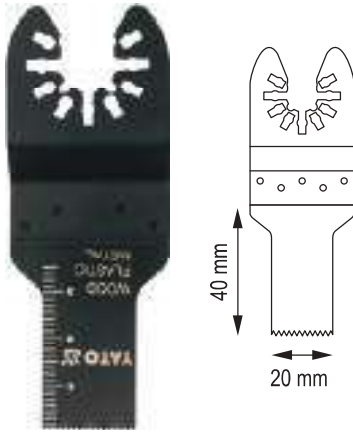
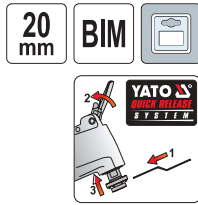

• Application: wood, plastic, metal, plaster, epoxy resin
 • Zastosowanie: drewno, plastik, metal, gips, żywica epoksydowa

For YT-82220, YT-82223, YT-82818, YT-82900
 Dla YT-82220, YT-82223, YT-82818, YT-82900

YATO 5/100
YT-34686

EN Plunge cutting saw blade for oscillating multitool BIM
 PL Brzeszczot wgłębny BIM do narzędzia wielofunkcyjnego
 DE Tiefenmesser BIM für Multifunktionswerkzeug
 RU Сабельное полотно BIM для многофункционального инструмента
 CZ Pilový list BIM na ponorné řezy pro multifunkční nářadí
 HU BIM merülő fűrészlap multifunkciós szerszámozhoz
 RO Lamă de adâncime BIM pt. unealta multifuncțională
 FR Lame plongeante BIM pour outils multifonctions
 IT Lama per tagli dal pieno BIM
 ES Hoja para cortes profundos BIM para herramienta multifuncional
 CN 锯片

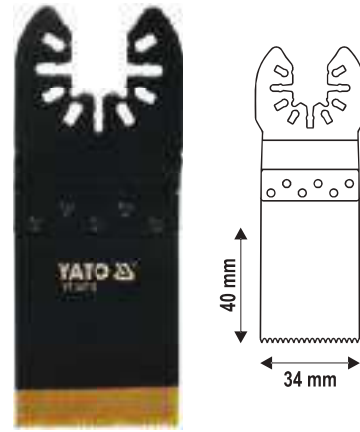
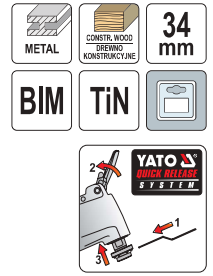

• Application: wood, metal
 • Zastosowanie: drewno, metal

For YT-82220
 Dla YT-82220

YATO 10/100
YT-34712

EN Plunge cutting saw blade for oscillating multitool HCS
 PL Brzeszczot wgłębny HCS do narzędzia wielofunkcyjnego
 DE Tiefenmesser HCS für Multifunktionswerkzeug
 RU Сабельное полотно HCS для многофункционального инструмента
 CZ Pilový list HCS na ponorné řezy pro multifunkční nářadí
 HU HCS merülő fűrészlap multifunkciós szerszámozhoz
 RO Lamă de adâncime HCS pt. unealta multifuncțională
 FR Lame plongeante HCS pour outils multifonctions
 IT Lama per tagli dal pieno HCS
 ES Hoja para cortes profundos HCS para herramienta multifuncional
 CN 锯片

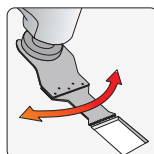
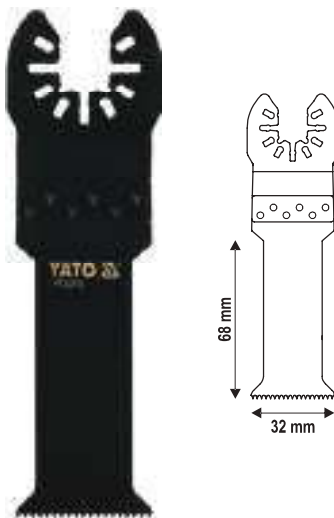
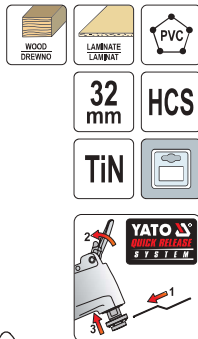

• Application: wood, laminate, plastic
 • Zastosowanie: drewno, laminat, plastik

For YT-82220
 Dla YT-82220

YATO 10/100
YT-34710

EN Plunge cutting saw blade for oscillating multitool HCS
 PL Brzeszczot wgłębny HCS do narzędzia wielofunkcyjnego
 DE Tiefenmesser HCS für Multifunktionswerkzeug
 RU Сабельное полотно HCS для многофункционального инструмента
 CZ Pilový list HCS na ponorné řezy pro multifunkční nářadí
 HU HCS merülő fűrészlap multifunkciós szerszámozhoz
 RO Lamă de adâncime HCS pt. unealta multifuncțională
 FR Lame plongeante HCS pour outils multifonctions
 IT Lama per tagli dal pieno HCS
 ES Hoja para cortes profundos HCS para herramienta multifuncional
 CN 锯片

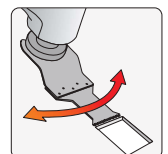
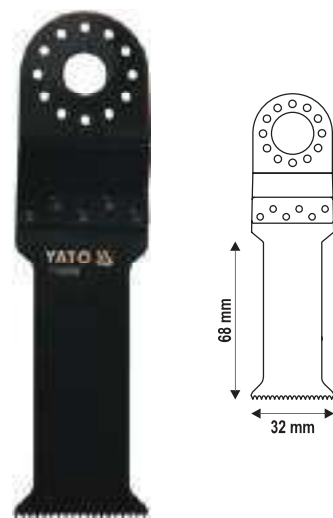
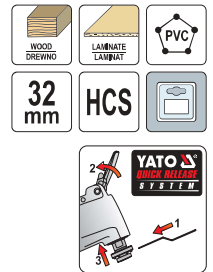

• Application: wood, laminate, plastic
 • Zastosowanie: drewno, laminat, plastik

For YT-82223
 Dla YT-82223

YATO 10/100
YT-34700

EN Plunge cutting saw blade for oscillating multitool BIM
 PL Brzeszczot wgłębny BIM do narzędzia wielofunkcyjnego
 DE Tiefenmesser BIM für Multifunktionswerkzeug
 RU Сабельное полотно BIM для многофункционального инструмента
 CZ Pílový list BIM na pomocné řezy pro multifunkční nářadí
 HU BIM merülő fűrészlap multifunkciós szerszámoz
 RO Lamă de adâncime BIM pt. unealta multifuncțională
 FR Lame plongeante BIM pour outils multifonctions
 IT Lama per tagli dal pieno BIM
 ES Hoja para cortes profundos BIM para herramienta multifuncional
 CN 锯片

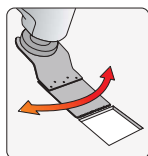
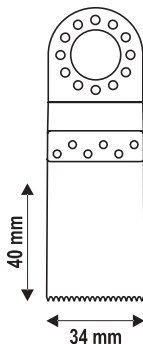
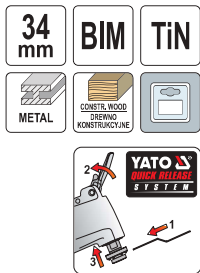

• Application: wood, metal
 • Zastosowanie: drewno, metal

For YT-82223
 Dla YT-82223

YATO  
 YT-34702 10/100

EN Plunge cutting saw blade for oscillating multitool BIM
 PL Brzeszczot wgłębny BIM do narzędzia wielofunkcyjnego
 DE Tiefenmesser BIM für Multifunktionswerkzeug
 RU Сабельное полотно BIM для многофункционального инструмента
 CZ Pílový list BIM na pomocné řezy pro multifunkční nářadí
 HU BIM merülő fűrészlap multifunkciós szerszámoz
 RO Lamă de adâncime BIM pt. unealta multifuncțională
 FR Lame plongeante BIM pour outils multifonctions
 IT Lama per tagli dal pieno BIM
 ES Hoja para cortes profundos BIM para herramienta multifuncional
 CN 锯片

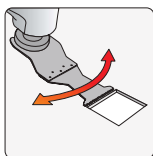
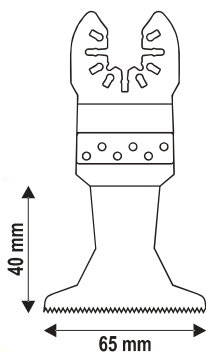
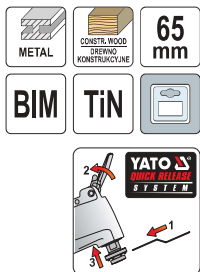

• Application: wood, metal
 • Zastosowanie: drewno, metal

For YT-82220
 Dla YT-82220

YATO  
 YT-34713 10/100

EN Plunge cutting saw blade for oscillating multitool BIM
 PL Brzeszczot wgłębny BIM do narzędzia wielofunkcyjnego
 DE Tiefenmesser BIM für Multifunktionswerkzeug
 RU Сабельное полотно BIM для многофункционального инструмента
 CZ Pílový list BIM na pomocné řezy pro multifunkční nářadí
 HU BIM merülő fűrészlap multifunkciós szerszámoz
 RO Lamă de adâncime BIM pt. unealta multifuncțională
 FR Lame plongeante BIM pour outils multifonctions
 IT Lama per tagli dal pieno BIM
 ES Hoja para cortes profundos BIM para herramienta multifuncional
 CN 锯片

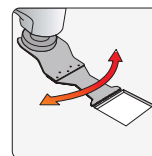
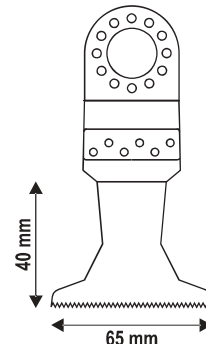
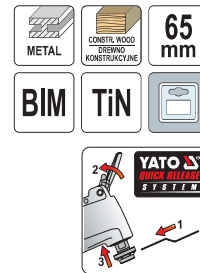

• Application: wood, metal
 • Zastosowanie: drewno, metal

For YT-82223
 Dla YT-82223

YATO  
 YT-34703 10/100

EN Brazed carbide triangular rasp for oscillating multitool
 PL Tarnik trójkątny do narzędzia wielofunkcyjnego
 DE Dreieckige Raspel für Multifunktionswerkzeug
 RU Треугольный рашпиль для многофункционального инструмента
 CZ Trojúhelníková brusná deska pro multifunkční nářadí
 HU Háromszög keresztmetszetű reszelő multifunkciós szerszámoz
 RO Raspel triunghiular pt. unealta multifuncțională
 FR Plateau de ponçage à concretion carbure pour outil multifonction
 IT Raspa in metallo duro forma triangolare multi-funzione
 ES Escofli triangular para herramienta multifuncional
 CN 锯片

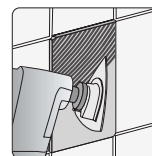
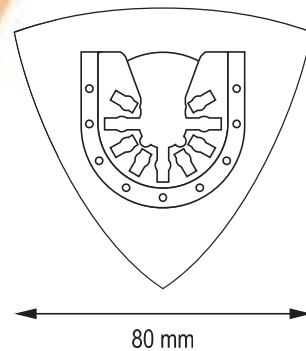
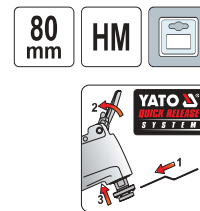

• Application: concrete, ceramic materials
 • Zastosowanie: beton, materiały ceramiczne

For YT-82220, YT-82223, YT-82818, YT-82900
 Dla YT-82220, YT-82223, YT-82818, YT-82900

YATO  
 YT-34687 10/100

EN Short scraper for oscillating multitool
 PL Skrobak do narzędzia wielofunkcyjnego
 DE Schaber für Multifunktionswerkzeug
 RU Скребок для многофункционального инструмента
 CZ Škrabka pro multifunkční nářadí
 HU Kaparó multifunkciós szerszámhoz
 RO Răzuitor pt. unealta multifuncțională
 FR Spatule pour outil multifonction
 IT Raschietto oscillante multifunzione adatto
 ES Raspador para herramienta multifuncional
 CN 锯片



52 mm
HCS

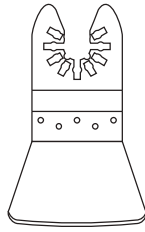

52 mm

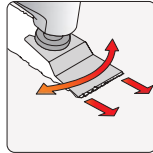

• Application: paint, adhesives, sealing compounds
 • Zastosowanie: farby, kleje, masy uszczelniające

For YT-82220, YT-82223, YT-82818, YT-82900
 Dla YT-82220, YT-82223, YT-82818, YT-82900

YATO
YT-34688 10/100

EN Triangular eva sanding pad for oscillating multitool
 PL Stopa szlifierska do narzędzia wielofunkcyjnego
 DE Schleifplatte für Multifunktionswerkzeug
 RU Шлифовальная насадка для многофункционального инструмента
 CZ Brusný nástavec pro multifunkční nářadí
 HU Csiszoló talp multifunkciós szerszámhoz
 RO Picioar de sablare pt. unealta multifuncțională
 FR Plateau de ponçage pour outil multifonction
 IT Tasso di smerigliatrice multifunzionale
 ES Pie de rectificación para herramienta multifuncional
 CN 抛光盘



90 mm
EVA

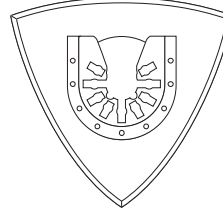

90 mm



• Application: wood, metal, plaster
 • Zastosowanie: drewno, metal, gips

For YT-82220, YT-82223, YT-82818, YT-82900
 Dla YT-82220, YT-82223, YT-82818, YT-82900

YATO
YT-34689 10/100

EN Triangular sanding pad for oscillating multitool
 PL Stopa szlifierska do narzędzia wielofunkcyjnego
 DE Schleifplatte für Multifunktionswerkzeug
 RU Шлифовальная бумага для многофункционального инструмента
 CZ Brusný nástavec pro multifunkční nářadí
 HU Csiszoló papír multifunkciós szerszámhoz
 RO Hârtie abrazivă pt. unealta multifuncțională
 FR Feuilles abrasives pour outil multifonction
 IT Tasso di smerigliatrice multifunzionale
 ES Papel de lija para herramienta multifuncional
 CN 抛光拉绒砂盘

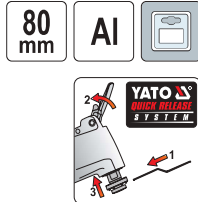

80 mm

Al

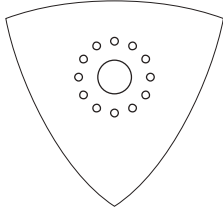

80 mm

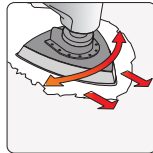

For YT-82223
 Dla YT-82223

• Application: wood, metal, plaster
 • Zastosowanie: drewno, metal, gips

YATO
YT-34692 10/100

EN Triangular sand paper for oscillating multitool
 PL Papier ścierny do narzędzia wielofunkcyjnego
 DE Schleifpapier für Multifunktionswerkzeug
 RU Шлифовальная бумага для многофункционального инструмента
 CZ Brusné plátno pro multifunkční nářadí
 HU Csiszoló papír multifunkciós szerszámhoz
 RO Hârtie abrazivă pt. unealta multifuncțională
 FR Feuilles abrasives pour outil multifonction
 IT Carta abrasiva per utensile multifunzione
 ES Papel de lija para herramienta multifuncional
 CN 抛光拉绒砂盘

10 PCS



90 mm



• Application: wood, metal, plaster
 • Zastosowanie: drewno, metal, gips

For YT-82220, YT-82223, YT-82818, YT-82900
 Dla YT-82220, YT-82223, YT-82818, YT-82900

YATO
YT-34690 10/100

EN Triangular sand paper for oscillating multitool
 PL Papier ścierny do narzędzia wielofunkcyjnego
 DE Schleifpapier für Multifunktionswerkzeug
 RU Набор принадлежностей для многофункционального инструмента
 CZ Brusné plátno pro multifunkční nářadí
 HU Csiszoló papír multifunkciós szerszámhoz
 RO Hârtie abrazivă pt. unealta multifuncțională
 FR Feuilles abrasives pour outil multifonction
 IT Carta abrasiva per utensile multifunzione
 ES Papel de lija para herramienta multifuncional
 CN 抛光拉绒砂盘

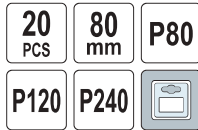

20 PCS

80 mm

P80

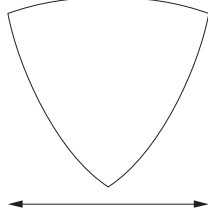
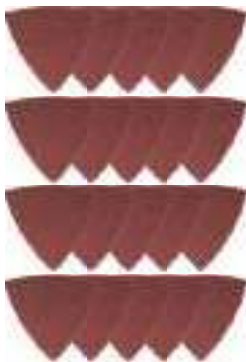

80 mm

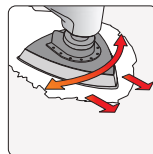

• Application: wood, metal, plaster
 • Zastosowanie: drewno, metal, gips

For YT-82220, YT-82223, YT-82818, YT-82900
 Dla YT-82220, YT-82223, YT-82818, YT-82900
 P80 (10 PCS), P120 (5 PCS), P240 (5 PCS)

YATO
YT-34693 5/50

EN Accessories set for oscillating multitool
 PL Zestaw akcesoriów do narzędzia wielofunkcyjnego
 DE Zubehörsatz für Multifunktionswerkzeug
 RU Набор принадлежностей для многофункционального инструмента
 CZ Souprava příslušenství pro multifunkční nářadí
 HU Tartozék szett multifunkciós szerszámhoz
 RO Set de accesorii pt. unealta multifuncțională
 FR Set d'accessoires pour outil multifonction
 IT Set di accessori per utensile multifunzione
 ES Juego de accesorios para herramienta multifuncional
 CN 锯片附件



3 PCS

HSS

HCS

BIM

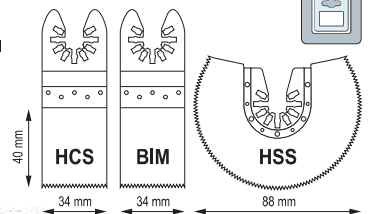

40 mm

34 mm

34 mm

88 mm

• Application: wood, plastic, metal, plaster, epoxy resin
 • Zastosowanie: drewno, plastik, metal, gips, żywica epoksydowa

For YT-82220, YT-82223, YT-82818, YT-82900
 Dla YT-82220, YT-82223, YT-82818, YT-82900

YATO
YT-34691 10/100

EN Tube wire brush
PL Szczotka druciana cylindryczna
DE Zylinder-Drahtbürste
RU Щетка-ерш для чистки труб
CZ Kartáč na trubky
HU Tisztító béső kefe

RO Perie sarma de curatat tevi
FR Brosse cylindrique pour tubes en fil d'acier ondulé
IT Spazzola metallica a cilindro
ES Cepillos en espiral para tubos
CN 试管刷



YATO	Dimensions / Wymiary [mm]	
YT-47695	20x65x200	10/80
YT-47696	26x65x200	10/80
YT-47697	32x65x200	10/80
YT-47698	38x65x200	10/80

EN Steel wire brush
PL Szczotka druciana
DE Stahldrahtbürste

RU Щетка стальная
CZ Drátěný kartáč
HU Drótkefe

RO Perie de sârmă
FR Brosse de fil en laiton
IT Spazzola metallica

ES Cepillo de acero
CN 塑柄钢丝刷



YATO	Row quantity / Liczba rzędów	
YT-6353	3	12/120
YT-6354	4	12/120
YT-6355	5	12/120
YT-6356	6	12/120

YATO	Row quantity / Liczba rzędów	
YT-6358	4	12/72
YT-6359	5	12/72
YT-6360	6	12/72

EN Steel wire brush
PL Szczotka druciana
DE Stahldrahtbürste
RU Щетка стальная
CZ Drátěný kartáč
CN 钢丝刷

RO Perie de sârmă
FR Brosse de fil en laiton
IT Spazzola metallica
ES Cepillo de acero
CN 钢丝刷



YATO	Row quantity / Liczba rzędów	L [mm]	
YT-6330	3	340	12/72

YATO	Row quantity / Liczba rzędów	L [mm]	
YT-6331	3	340	12/72



YATO	Row quantity / Liczba rzędów	L [mm]	
YT-6332	4	260	12/72

YATO	Row quantity / Liczba rzędów	L [mm]	
YT-6333	4	290	12/72

YATO	Row quantity / Liczba rzędów	Size / Rozmiar [mm]	
YT-6334	6	180x65	12/60



YATO	Row quantity / Liczba rzędów	L [mm]	
YT-6335	3	340	12/72

YATO	Row quantity / Liczba rzędów	L [mm]	
YT-6336	3	340	12/72

YATO	Row quantity / Liczba rzędów	L [mm]	
YT-6337	3	180	24/144



YATO	Row quantity / Liczba rzędów	L [mm]	
YT-6338	4	260	12/72

YATO	Row quantity / Liczba rzędów	L [mm]	
YT-6339	4	290	12/72

YATO	Row quantity / Liczba rzędów	L [mm]	
YT-6340	5	180	24/120



YATO	Row quantity / Liczba rzędów	L [mm]	
YT-6341	3	340	12/72

YATO	Row quantity / Liczba rzędów	L [mm]	
YT-6343	3	180	24/144

YATO	Row quantity / Liczba rzędów	L [mm]	
YT-6344	4	260	12/72



YATO	Row quantity / Liczba rzędów	L [mm]	
YT-6345	4	290	12/72

YATO	Row quantity / Liczba rzędów	L [mm]	
YT-6346	5	180	24/120

YATO	Row quantity / Liczba rzędów	L [mm]	
YT-6349	5	180	24/120



EN Plastic handle wire brush set
PL Komplet szczotek drucianych
DE Bürstensatz
RU Набор стальных щеток
CZ Drátěný kartáče
HU Kefekészlet
RO Set perie de sarma
FR Set de brosses de fil en laiton
IT Set di spazzole metalliche
ES Juego de cepillos
CN 刷子组套



YATO	Row quantity / Liczba rzędów	L [mm]	
YT-6351	3	180	24/144



EN Cup brush with shaft
 PL Szczotka czolowa z trzpieniem
 DE Stahldraht-Topfbürste
 RU Щетка "чашка" со стержнем
 CZ Čelní kartáč drátěný se stopkou
 HU Homlok drótkéfe, nyéllel
 RO Perie frontală pt. bomasina
 FR Brosse coupe avec goupille
 IT Spazzola a tazza
 ES Cepillo de copa con mandril
 CN 钢丝轮



YATO 	Ø [mm]	max. c [min ⁻¹]	
YT-4750	75	4500	12/96



EN Cup brush with shaft
 PL Szczotka czolowa z trzpieniem
 DE Stahldraht-Topfbürste
 RU Щетка "чашка" со стержнем
 CZ Čelní kartáč drátěný se stopkou
 HU Homlok drótkéfe, nyéllel
 RO Perie frontală pt. bomasina
 FR Brosse coupe avec goupille
 IT Spazzola a tazza
 ES Cepillo de copa con mandril
 CN 钢丝轮



YATO 	Ø [mm]	max. c [min ⁻¹]	
YT-4751	75	4500	12/96



EN Cup brush with shaft
 PL Szczotka czolowa z trzpieniem
 DE Stahldraht-Topfbürste
 RU Щетка "чашка" со стержнем
 CZ Čelní kartáč drátěný se stopkou
 HU Homlok drótkéfe, nyéllel
 RO Perie frontală pt. bomasina
 FR Brosse coupe avec goupille
 IT Spazzola a tazza
 ES Cepillo de copa con mandril
 CN 钢丝轮



YATO 	Ø [mm]	max. c [min ⁻¹]	
YT-4752	75	6000	12/72



EN Cup brush with shaft
 PL Szczotka czolowa z trzpieniem
 DE Stahldraht-Topfbürste
 RU Щетка "чашка" со стержнем
 CZ Čelní kartáč drátěný se stopkou
 HU Homlok drótkéfe, nyéllel
 RO Perie frontală pt. bomasina
 FR Brosse coupe avec goupille
 IT Spazzola a tazza
 ES Cepillo de copa con mandril
 CN 带柄钢丝轮



YATO 	Ø [mm]	max. c [min ⁻¹]	
YT-47496	25	4500	20/240



EN Cup brush with shaft
 PL Szczotka czolowa z trzpieniem
 DE Stahldraht-Topfbürste
 RU Щетка "чашка" со стержнем
 CZ Čelní kartáč drátěný se stopkou
 HU Homlok drótkéfe, nyéllel
 RO Perie frontală pt. bomasina
 FR Brosse coupe avec goupille
 IT Spazzola a tazza
 ES Cepillo de copa con mandril
 CN 带柄钢丝轮



YATO 	Ø [mm]	max. c [min ⁻¹]	
YT-47497	50	4500	12/144



EN Cup brush with shaft
 PL Szczotka czolowa z trzpieniem
 DE Stahldraht-Topfbürste
 RU Щетка "чашка" со стержнем
 CZ Čelní kartáč drátěný se stopkou
 HU Homlok drótkéfe, nyéllel
 RO Perie frontală pt. bomasina
 FR Brosse coupe avec goupille
 IT Spazzola a tazza
 ES Cepillo de copa con mandril
 CN 带柄钢丝轮



YATO 	Ø [mm]	max. c [min ⁻¹]	
YT-47511	100	4500	6/36



EN Cup brush with shaft
 PL Szczotka czolowa z trzpieniem
 DE Stahldraht-Topfbürste
 RU Щетка "чашка" со стержнем
 CZ Čelní kartáč drátěný se stopkou
 HU Homlok drótkéfe, nyéllel
 RO Perie frontală pt. bomasina
 FR Brosse coupe avec goupille
 IT Spazzola a tazza
 ES Cepillo de copa con mandril
 CN 带柄钢丝轮



YATO 	Ø [mm]	max. c [min ⁻¹]	
YT-47518	65	12500	10/100



EN Cup brush with shaft
 PL Szczotka czolowa z trzpieniem
 DE Stahldraht-Topfbürste
 RU Щетка "чашка" со стержнем
 CZ Čelní kartáč drátěný se stopkou
 HU Homlok drótkéfe, nyéllel
 RO Perie frontală pt. bomasina
 FR Brosse coupe avec goupille
 IT Spazzola a tazza
 ES Cepillo de copa con mandril
 CN 带柄尼龙刷



YATO 	Ø [mm]	max. c [min ⁻¹]	
YT-47780	25	4500	20/240

EN Cup brush with shaft
 PL Szczotka czolowa z trzpieniem
 DE Stahldraht-Topfbürste
 RU Щетка "чашка" со стержнем
 CZ Čelní kartáč drátěný se stopkou
 HU Homlok drótkéfe, nyéllel
 RO Perie frontală pt. bomasina
 FR Brosse coupe avec goupille
 IT Spazzola a tazza
 ES Cepillo de copa con mandril
 CN 带柄尼龙刷



YATO 	Ø [mm]	max. c [min ⁻¹]	
YT-47782	75	4500	10/120

EN Cup brush with shaft set
 PL Szczotki druciane z trzpieniem
 DE Drahtbürste mit Einspanschaft
 RU Щетки проволочные со стержнем
 CZ Drátěný kartáč se stopkou
 HU Drótkéfe, csapós
 RO Perii de sârmă cu tijă
 FR Set de brosses coupe avec goupille
 IT Spazzola metallica a disco
 ES Cepillos de alambre con espiga
 CN 三件钢丝刷组套



YATO 	Ø [mm]	max. c [min ⁻¹]	
YT-4755	20, 50, 50	6000, 7500, 4500	12/60

EN Circular brush with shaft
PL Szczotka tarczowa z trzpieniem
DE Stahldraht-Scheibenbürste
RU Щетка круговая со стержнем
CZ Okružní kartáč drátěný se stopkou
HU Tarcás drótkéfe, nyéllel
RO Perie rotunda pt. bormasina
FR Brosse circulaire avec goupille
IT Spazzola a disco
ES Cepillo redondo
CN 钢丝轮



YATO 	Ø [mm]	max. ω [min ⁻¹]	
YT-4757	100	4500	12/96

EN Circular brush with shaft
PL Szczotka tarczowa z trzpieniem
DE Stahldraht-Scheibenbürste
RU Щетка круговая со стержнем
CZ Okružní kartáč drátěný se stopkou
HU Tarcás drótkéfe, nyéllel
RO Perie rotunda pt. bormasina
FR Brosse circulaire avec goupille
IT Spazzola a disco
ES Cepillo redondo
CN 钢丝轮



YATO 	Ø [mm]	max. ω [min ⁻¹]	
YT-4758	100	4500	12/96

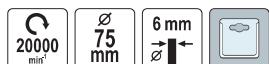

EN Circular brush with shaft
PL Szczotka tarczowa z trzpieniem
DE Stahldraht-Scheibenbürste
RU Щетка круговая со стержнем
CZ Okružní kartáč drátěný se stopkou
HU Tarcás drótkéfe, nyéllel
RO Perie rotunda pt. bormasina
FR Brosse circulaire avec goupille
IT Spazzola a disco
ES Cepillo redondo
CN 钢丝轮



YATO 	Ø [mm]	max. ω [min ⁻¹]	
YT-4759	75	20000	10/100



EN Circular brush with shaft
PL Szczotka tarczowa z trzpieniem
DE Stahldraht-Scheibenbürste
RU Щетка круговая со стержнем
CZ Okružní kartáč drátěný se stopkou
HU Tarcás drótkéfe, nyéllel
RO Perie rotunda pt. bormasina
FR Brosse circulaire avec goupille
IT Spazzola a disco
ES Cepillo redondo
CN 钢丝轮



YATO 	Ø [mm]	max. ω [min ⁻¹]	
YT-4756	50	4500	20/240
YT-4758	75	4500	12/144



EN Circular brush with shaft
PL Szczotka tarczowa z trzpieniem
DE Stahldraht-Scheibenbürste
RU Щетка круговая со стержнем
CZ Okružní kartáč drátěný se stopkou
HU Tarcás drótkéfe, nyéllel
RO Perie rotunda pt. bormasina
FR Brosse circulaire avec goupille
IT Spazzola a disco
ES Cepillo redondo
CN 钢丝轮



YATO 	Ø [mm]	max. ω [min ⁻¹]	
YT-47791	75	4500	10/120
YT-47792	100	4500	10/60

EN Circular brush with shaft
PL Szczotka tarczowa z trzpieniem
DE Stahldraht-Scheibenbürste
RU Щетка круговая со стержнем
CZ Okružní kartáč drátěný se stopkou
HU Tarcás drótkéfe, nyéllel
RO Perie rotunda pt. bormasina
FR Brosse circulaire avec goupille
IT Spazzola a disco
ES Cepillo redondo
CN 钢丝轮



YATO 	Ø [mm]	max. ω [min ⁻¹]	
YT-4780	50	4500	6/36
YT-47801	75	4500	6/36
YT-47802	100	4500	6/36



EN Cup brush with shaft set
PL Szczotki druciane z trzpieniem
DE Drahtbürste mit Einspannschaft
RU Щетки проволочные со стержнем
CZ Drátěný kartáč se stopkou
HU Drótkéfe, csapós
RO Perii de sârmă cu tijă
FR Set de brosses coupe avec goupille
IT Spazzola metallica a disco
ES Cepillos de alambre con espiga
CN 钢丝刷



YATO 	Ø [mm]	max. ω [min ⁻¹]	
YT-47593	37, 50, 62, 75	4500	6/60



EN Circular brush
 PL Szczotka tarczowa z gwintem
 DE Stahldraht-Scheibenbürste
 RU Щетка пырочная
 CZ Okružní kartáč drátěný
 HU Tarcás drótkéfe
 RO Perie rotunda pt. bormasina
 FR Brosse circulaire avec filet
 IT Spazzola conica
 ES Cepillo redondo
 CN 钢丝轮



YATO 	Ø [mm]	max. ω [min ⁻¹]	
YT-4761	100	12500	8/64

EN Circular brush
 PL Szczotka tarczowa z gwintem
 DE Stahldraht-Scheibenbürste
 RU Щетка пырочная
 CZ Okružní kartáč drátěný
 HU Tarcás drótkéfe
 RO Perie rotunda pt. bormasina
 FR Brosse circulaire avec filet
 IT Spazzola conica
 ES Cepillo redondo
 CN 钢丝轮



YATO 	Ø [mm]	max. ω [min ⁻¹]	
YT-4763	100	12500	8/64

EN Circular brush
 PL Szczotka tarczowa z gwintem
 DE Stahldraht-Scheibenbürste
 RU Щетка пырочная
 CZ Okružní kartáč drátěný
 HU Tarcás drótkéfe
 RO Perie rotunda pt. bormasina
 FR Brosse circulaire avec filet
 IT Spazzola conica
 ES Cepillo redondo
 CN 钢丝轮



YATO 	Ø [mm]	max. ω [min ⁻¹]	
YT-4764	125	10000	8/48

EN Circular brush
 PL Szczotka tarczowa z gwintem
 DE Stahldraht-Scheibenbürste
 RU Щетка пырочная
 CZ Okružní kartáč drátěný
 HU Tarcás drótkéfe
 RO Perie rotunda pt. bormasina
 FR Brosse circulaire avec filet
 IT Spazzola conica
 ES Cepillo redondo
 CN 钢丝轮



YATO 	Ø [mm]	max. ω [min ⁻¹]	
YT-47612	125	12500	10/60

EN Cup brush
 PL Szczotka czolowa z gwintem
 DE Stahldraht-Topfbürste
 RU Щетка "чашка"
 CZ Čelní kartáč drátěný
 HU Homlok drótkéfe
 RO Perie frontală
 FR Brosse coupe avec filet
 IT Spazzola conica
 ES Cepillo de copa
 CN 钢丝轮



YATO 	Ø [mm]	max. ω [min ⁻¹]	
YT-4766	100	8500	4/32



EN Cup brush
 PL Szczotka czolowa z gwintem
 DE Stahldraht-Topfbürste
 RU Щетка "чашка"
 CZ Čelní kartáč drátěný
 HU Homlok drótkéfe
 RO Perie frontală
 FR Brosse coupe avec filet
 IT Spazzola conica
 ES Cepillo de copa
 CN 钢丝轮



YATO 	Ø [mm]	max. ω [min ⁻¹]	
YT-4767	60	12500	10/80

EN Cup brush
 PL Szczotka czolowa z gwintem
 DE Stahldraht-Topfbürste
 RU Щетка "чашка"
 CZ Čelní kartáč drátěný
 HU Homlok drótkéfe
 RO Perie frontală
 FR Brosse coupe avec filet
 IT Spazzola conica
 ES Cepillo de copa
 CN 钢丝轮



YATO 	Ø [mm]	max. ω [min ⁻¹]	
YT-4768	75	11000	6/36



EN Cup brush
 PL Szczotka czolowa z gwintem
 DE Stahldraht-Topfbürste
 RU Щетка "чашка"
 CZ Čelní kartáč drátěný
 HU Homlok drótkéfe
 RO Perie frontală
 FR Brosse coupe avec filet
 IT Spazzola conica
 ES Cepillo de copa
 CN 钢丝轮



YATO 	Ø [mm]	max. ω [min ⁻¹]	
YT-4769	100	8500	4/16



EN Cup brush
PL Szczotka czolowa z gwintem
DE Stahldraht-Topfbürste
RU Щетка "чашка"
CZ Čelní kartáč drátěný
HU Homlok drótkéfe
RO Perie frontală
FR Brosse coupe avec filet
IT Spazzola conica
ES Cepillo de copa
CN 钢丝轮



YATO 	Ø [mm]	max. c [min ⁻¹]	
YT-47691	125	6500	4/16



EN Cup brush
PL Szczotka czolowa z gwintem
DE Stahldraht-Topfbürste
RU Щетка "чашка"
CZ Čelní kartáč drátěný
HU Homlok drótkéfe
RO Perie frontală
FR Brosse coupe avec filet
IT Spazzola conica
ES Cepillo de copa
CN 钢丝轮



YATO 	Ø [mm]	max. c [min ⁻¹]	
YT-47658	65	12500	10/80



EN Cup brush
PL Szczotka czolowa z gwintem
DE Stahldraht-Topfbürste
RU Щетка "чашка"
CZ Čelní kartáč drátěný
HU Homlok drótkéfe
RO Perie frontală
FR Brosse coupe avec filet
IT Spazzola conica
ES Cepillo de copa
CN 尼龙刷



YATO 	Ø [mm]	max. c [min ⁻¹]	
YT-47785	65	12200	10/80
YT-47787	125	6500	6/24

EN Circular brush
PL Szczotka tarczowa z gwintem
DE Stahldraht-Scheibenbürste
RU Щетка круглая
CZ Okružní kartáč drátěný
HU Tarcás drótkéfe
RO Perie rotundă pt. bormasina
FR Brosse circulaire avec filet
IT Spazzola conica
ES Cepillo redondo
CN 带柄平行刷



YATO 	Ø [mm]	max. c [min ⁻¹]	
YT-47554	150x32	6000	5/40
YT-47555	200x32	4500	5/20



EN Metal grinding disc
PL Tarcza do szlifowania metalu
DE Metall-Schleif-scheibe
RU Круги для шлифования по металлу
CZ Kolečko pro broušení kovu
HU Vágókorong fémhöz
RO Disc pt. șlefuit metal
FR Disque de polissage pour métaux
IT Disco per rettifica metallo
ES Disco cortador para metalo
CN 研磨片



YATO 	Ø [mm]	max. c [min ⁻¹]	
YT-47820	125	12500	6/36

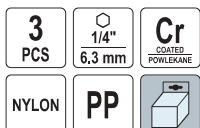

EN Drill powered scrub brushes
PL Zestaw szczotek na wiertarkę
DE Bürstensatz für Bohrmaschine
RU Набор щеток для дрели
CZ Sada uhliků do vrtačky
HU Kefekészlet fúróhoz
RO Set perii cu prindere
FR Ensemble de brosses pour perceuse
IT Set di spazzole per trapano
ES Juego de cepillos para taladro
CN 清洁刷



YATO 	Ø [mm]	
YT-47553	50, 80, 100	40

EN Drill powered scrub brushes
PL Zestaw szczotek na wiertarkę
DE Bürstensatz für Bohrmaschine
RU Набор щеток для дрели
CZ Sada uhliků do vrtačky
HU Kefekészlet fúróhoz
RO Set perii cu prindere
FR Ensemble de brosses pour perceuse
IT Set di spazzole per trapano
ES Juego de cepillos para taladro
CN 清洁刷



YATO 	Ø [mm]	
YT-47777	5, 8, 10, 12 (x2)	24

EN Electrician's knife
 PL Nóż składany monterski
 DE Montagemesser
 RU Нож складной
 CZ Montážní nůž
 HU Szerelőkés
 RO Cuiț pt. decablat
 FR Couteau d'électricien
 IT Coltello
 ES Cuchillo de montaje
 CN 直刀电工刀

HRC 42-48
 3Cr13



85/200 mm

YATO L [mm]
 YT-7600 200 6/96



75/190 mm

YATO L [mm]
 YT-7601 190 6/96

EN Folding knife with bits
 PL Nóż składany z bitami
 DE Klappmesser
 RU Нож складной
 CZ Kapesní nůž
 HU Zsebkés
 RO Briceag
 FR Couteau pince multifonction avec embouts
 IT Coltello pieghevole con punte
 ES Navaja
 CN 折叠刀

AI
 SS
 STAINLESS STEEL
 STAL NIERZEWA



3, 4 mm;
 PH1, PH2 mm;
 3, 4 mm;
 T10, T20

YATO
 YT-76031 6/48

EN Folding knife
 PL Nóż składany
 DE Klappmesser
 RU Нож складной
 CZ Kapesní nůž
 HU Zsebkés
 RO Briceag
 FR Couteau pliant
 IT Coltello pieghevole
 ES Navaja
 CN 带登山扣的折叠刀

SS
 STAINLESS STEEL
 STAL NIERZEWA



AI

YATO
 YT-76050 12/72



YATO
 YT-76051 12/120



YATO
 YT-76052 6/48

EN Multi knife
 PL Narzędzie wielofunkcyjne
 DE Klappmesser
 RU Нож складной
 CZ Kapesní nůž
 HU Zsebkés
 RO Briceag
 FR Couteau pince multifonction
 IT Pinza multifunzione
 ES Navaja
 CN 多功能折叠刀

9 PCS
 SS
 STAINLESS STEEL
 STAL NIERZEWA
 AI



YATO
 YT-76040 12/120

EN Multi knife
 PL Narzędzie wielofunkcyjne
 DE Klappmesser
 RU Нож складной
 CZ Kapesní nůž
 HU Zsebkés
 RO Briceag
 FR Couteau pince multifonction
 IT Pinza multifunzione
 ES Navaja
 CN 多功能折叠刀

9 PCS
 SS
 STAINLESS STEEL
 STAL NIERZEWA
 AI



YATO
 YT-76041 12/48

EN Multi knife
PL Narzędzie wielofunkcyjne
DE Klappmesser
RU Нож складной
CZ Kapesní nůž
HU Zsebkés
RO Briceag
FR Couteau pince multifonction
IT Pinza multifunzione
ES Navaja
CN 多功能折叠刀

9
PCS
SS
STAINLESS STEEL
STAL NIERDZEWNA
AI



YATO
YT-76042

12/48

EN Multi knife
PL Narzędzie wielofunkcyjne
DE Klappmesser
RU Нож складной
CZ Kapesní nůž
HU Zsebkés
RO Briceag
FR Couteau pince multifonction
IT Pinza multifunzione
ES Navaja
CN 多功能折叠刀

9
PCS
SS
STAINLESS STEEL
STAL NIERDZEWNA



YATO
YT-76043

6/36

EN Cutter knife
PL Nożyk z ostrzem trapezowym
DE Cuttermesser
RU Нож универсальный
CZ Univerzální nůž s lichoběžníkovou čepelí
HU Univerzális kés

RO Cuițit cu lamă trapezoidală retractabilă
FR Cutter à lame trapezoidale
IT Coltellino con lama trapezoidale
ES Cuchillo con hoja trapezoidal
CN 折叠实用刀

1+5
61x33x0.5
mm



SK5

YATO
YT-7532

Blade size / Rozmiar ostrza [mm]
61x33x0.5

12/72

EN Cutter knife
PL Nożyk z ostrzem trapezowym
DE Cuttermesser
RU Нож универсальный
CZ Univerzální nůž s lichoběžníkovou čepelí
HU Univerzális kés

RO Cuițit cu lamă trapezoidală retractabilă
FR Cutter à lame trapezoidale
IT Coltellino con lama trapezoidale
ES Cuchillo con hoja trapezoidal
CN 折叠实用刀

x5
61x33x0.5
mm



150
mm
SK5

YATO
YT-7534

Blade size / Rozmiar ostrza [mm]
61x33x0.5

12/72

EN Cutter knife
PL Nożyk z ostrzem trapezowym
DE Cuttermesser
RU Нож универсальный
CZ Univerzální nůž s lichoběžníkovou čepelí
HU Univerzális kés

RO Cuițit cu lamă trapezoidală retractabilă
FR Cutter à lame trapezoidale
IT Coltellino con lama trapezoidale
ES Cuchillo con hoja trapezoidal
CN 折叠实用刀

x3
61x33x0.5
mm



SK5

YATO
YT-7520

Blade size / Rozmiar ostrza [mm]
61x33x0.5

6/48

EN Cutter knife
PL Nożyk z ostrzem trapezowym
DE Cuttermesser
RU Нож универсальный
CZ Univerzální nůž s lichoběžníkovou čepelí
HU Univerzális kés

RO Cuițit cu lamă trapezoidală retractabilă
FR Cutter à lame trapezoidale
IT Coltellino con lama trapezoidale
ES Cuchillo con hoja trapezoidal
CN 折叠实用刀

1+3
61x33x0.5
mm
3
BLADE POSITIONS
POZYCJE OSTRZA
Zn
TPR
ABS



STRAP SIDE CUTTER
OBOKIN BOCZNY



SK5

YATO
YT-75201

Blade size / Rozmiar ostrza [mm]
61x33x0.5

12/72

EN Utility knife
PL Nożyk z łamany ostrzem
DE Abbrechklingen-Messer
RU Нож строительный
CZ Nůž úlamovací
HU Univerzális kés
RO Cuițit universal (cutter)
FR Cutter à lame sécable
IT Taglierino
ES Cuchillo de papelería
CN 美工刀

9
mm
1+2
ABS
TPR
AUTO
LOCK
BLOKADA
METAL
SLIDING BAR
METALOWA
PROWADNICA
SELF-LOADING
BLADES
SAMOŁADUJĄCE
OSTRZA
SK5



YATO
YT-75001

Blade size / Rozmiar ostrza [mm]
9x0.4

12/144

EN Utility knife
PL Nożyk z łamany ostrzem
DE Abbrechklingen-Messer
RU Нож строительный
CZ Nůž úlamovací
HU Univerzális kés
RO Cuițit universal (cutter)
FR Cutter à lame sécable
IT Taglierino
ES Cuchillo de papelería
CN 美工刀

9
mm
AUTO
LOCK
BLOKADA
METAL
SLIDING BAR
METALOWA
PROWADNICA
METAL
BODY
METALOWY
KORPUS
SK2H



ULTRA SHARP

YATO
YT-75002

Blade size / Rozmiar ostrza [mm]
9x0.4

10/240

EN Utility knife
PL Nożyk z łamany ostrzem
DE Abbrechklingen-Messer
RU Нож строительный
CZ Nůž úlamovací
HU Univerzális kés
RO Cuițit universal (cutter)
FR Cutter à lame sécable
IT Taglierino
ES Cuchillo de papelería
CN 美工刀

9
mm
AUTO
LOCK
BLOKADA
METAL
BODY
METALOWY
KORPUS
METAL
SLIDING BAR
METALOWA
PROWADNICA
SK2H



YATO
YT-75003

Blade size / Rozmiar ostrza [mm]
9x0.4

10/240

EN Utility knife
PL Nożyk z łamany ostrzem
DE Abbrechklingen-Messer
RU Нож строительный
CZ Nůž úlamovací
HU Univerzális kés
RO Cuițit universal (cutter)
FR Cutter à lame sécable
IT Taglierino
ES Cuchillo de papelería
CN 美工刀

18
mm
AUTO
LOCK
BLOKADA
METAL
SLIDING BAR
METALOWA
PROWADNICA
ABS
SK2H



ULTRA SHARP

YATO
YT-75123

Blade size / Rozmiar ostrza [mm]
18x0.5

10/120

EN Utility knife
 PL Nożyk z lamany ostrzem
 DE Abbrechklingen-Messer
 RU Нож строительный
 CZ Nůž úlamovací
 HU Univerzális kés
 RO Cuțit universal (cutter)
 FR Cutter à lame sécable
 IT Taglierino
 ES Cuchillo de papelería
 CN 美工刀

18 mm SCREW LOCK BLOKADA ŚRUBOWA METAL SLIDING BAR METALOWA PROWADNICA ABS SK2H



ULTRA SHARP

YATO	Blade size / Rozmiar ostrza [mm]	
YT-75124	18x0.5	10/120

EN Utility knife
 PL Nożyk z lamany ostrzem
 DE Abbrechklingen-Messer
 RU Нож строительный
 CZ Nůž úlamovací
 HU Univerzális kés
 RO Cuțit universal (cutter)
 FR Cutter à lame sécable
 IT Taglierino
 ES Cuchillo de papelería
 CN 美工刀

18 mm max 20 kg AUTO LOCK BLOKADA METAL SLIDING BAR METALOWA PROWADNICA Zn TPR ABS SK5



YATO	Blade size / Rozmiar ostrza [mm]	
YT-75121	18x0.5	12/144

EN Utility knife
 PL Nożyk z lamany ostrzem
 DE Abbrechklingen-Messer
 RU Нож строительный
 CZ Nůž úlamovací
 HU Univerzális kés
 RO Cuțit universal (cutter)
 FR Cutter à lame sécable
 IT Taglierino
 ES Cuchillo de papelería
 CN 美工刀

18 mm max 20 kg AUTO LOCK BLOKADA METAL SLIDING BAR METALOWA PROWADNICA Zn TPR SK5



YATO	Blade size / Rozmiar ostrza [mm]	
YT-75122	18x0.5	12/144

EN Utility knife
 PL Nożyk z lamany ostrzem
 DE Abbrechklingen-Messer
 RU Нож строительный
 CZ Nůž úlamovací
 HU Univerzális kés
 RO Cuțit universal (cutter)
 FR Cutter à lame sécable
 IT Taglierino
 ES Cuchillo de papelería
 CN 美工刀

SK2



YATO	Blade size / Rozmiar ostrza [mm]	
YT-7511	9x0.4	24/288
YT-7512	18x0.5	12/96

EN Utility knife
 PL Nożyk z lamany ostrzem
 DE Abbrechklingen-Messer
 RU Нож строительный
 CZ Nůž úlamovací
 HU Univerzális kés
 RO Cuțit universal (cutter)
 FR Cutter à lame sécable
 IT Taglierino
 ES Cuchillo de papelería
 CN 美工刀

ABS TPR LOCK BLOKADA SK2



YATO	Blade size / Rozmiar ostrza [mm]	
YT-7506	9x0.4	24/240
YT-7507	18x0.5	12/144

EN Utility knife
 PL Nożyk z lamany ostrzem
 DE Abbrechklingen-Messer
 RU Нож строительный
 CZ Nůž úlamovací
 HU Univerzális kés
 RO Cuțit universal (cutter)
 FR Cutter à lame sécable
 IT Taglierino
 ES Cuchillo de papelería
 CN 美工刀

18 mm max 20 kg AUTO LOCK BLOKADA METAL SLIDING BAR METALOWA PROWADNICA ABS TPR SK5

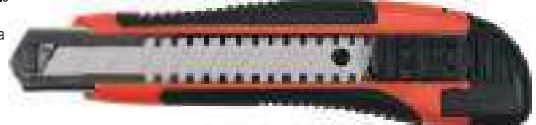

YATO	Blade size / Rozmiar ostrza [mm]	
YT-75071	18x0.5	12/144

EN Utility knife
 PL Nożyk z lamany ostrzem
 DE Abbrechklingen-Messer
 RU Нож строительный
 CZ Nůž úlamovací
 HU Univerzális kés
 RO Cuțit universal (cutter)
 FR Cutter à lame sécable
 IT Taglierino
 ES Cuchillo de papelería
 CN 美工刀

18 mm max 20 kg AUTO LOCK BLOKADA METAL SLIDING BAR METALOWA PROWADNICA ABS TPR SK5



YATO	Blade size / Rozmiar ostrza [mm]	
YT-75072	18x0.5	12/144

EN Utility knife
 PL Nożyk z lamany ostrzem
 DE Abbrechklingen-Messer
 RU Нож строительный
 CZ Nůž úlamovací
 HU Univerzális kés

RO Cuțit universal (cutter)
 FR Cutter à lame sécable
 IT Taglierino
 ES Cuchillo de papelería
 CN 美工刀

ABS SK2



YATO	Blade size / Rozmiar ostrza [mm]	
YT-7504	9x0.4	24/240
YT-7505	18x0.5	24/240

EN Utility knife
 PL Nożyk z lamany ostrzem
 DE Abbrechklingen-Messer
 RU Нож строительный
 CZ Nůž úlamovací
 HU Univerzális kés
 RO Cuțit universal (cutter)
 FR Cutter à lame sécable
 IT Taglierino
 ES Cuchillo de papelería
 CN 美工刀

25 mm max 20 kg AUTO LOCK BLOKADA METAL SLIDING BAR METALOWA PROWADNICA ABS TPR SK5

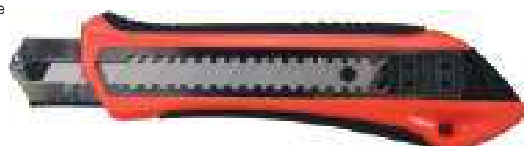

YATO	Blade size / Rozmiar ostrza [mm]	
YT-75101	25x0.7	12/144

EN Spare blades
 PL Ostrza zapasowe
 DE Abbrechklingen
 RU Лезвия для универсальных ножей
 CZ Lomené ostrží náhradní
 HU Törhető tartalékpenge

RO Lame de rezervă rupte
 FR Lame sécables pour le cutter
 IT Lame di ricambio
 ES Filo partido de recambio
 CN 美工刀片

10 PCS SK2H



ULTRA SHARP

YATO	Blade size / Rozmiar ostrza [mm]	
YT-75260	9x0.4	10/240
YT-75261	18x0.5	10/120

EN Spare blades
PL Ostrza zapasowe
DE Abbrechklingen
RU Лезвия для универсальных ножей
CZ Lomené ostří náhradní
HU Törhető tartalékpenge

RO Lame de rezervă rupte
FR Lame sécables pour le cutter
IT Lame di ricambio
ES Filo partido de recambio
CN 美工刀片

10
PCS

SK5



YATO	Blade size / Rozmiar ostrza [mm]	
YT-7528	9x0.4	24/144
YT-7529	18x0.5	24/144
YT-7530	25x0.7	6/48

EN Spare blades
PL Ostrza zapasowe
DE Abbrechklingen
RU Лезвия для универсальных ножей
CZ Lomené ostří náhradní
HU Törhető tartalékpenge

RO Lame de rezervă rupte
FR Lame sécables pour le cutter
IT Lame di ricambio
ES Filo partido de recambio
CN 美工刀片

10
PCS

SK2



YATO	Blade size / Rozmiar ostrza [mm]	
YT-7524	9x0.4	24/240
YT-7525	18x0.5	24/144
YT-75262	25x0.7	10/60

EN Squeegee with felt for pressing the film
PL Rakiel do dociskania folii
DE Folienpressraker
RU Ракель для прижатия пленки
CZ Stěrka pro přitlačení fólie
HU Fólia kasírozó

RO Racleta colant
FR Racloir à feuilles
IT Raschietto per pellicola
ES Rasqueta para presionar película
CN 毛毡刮片

100x73
mm



YATO	Size / Rozmiar [mm]	
YT-52550	100x73	20/200

EN Glass oil cutter
PL Nóż olejowy do szkła
DE Glasschneider

RU Стеклорез масляный
CZ Řezák na sklo
HU Olajkés üveghéz

RO Diamant pt. tăiat sticlă cu ulei
FR Couteau à l'huile pour verre
IT Taglia vetro con serbatoio olio

ES Cuchillo de aceite para cristalinación
CN 玻璃刮刀

HRA
92.5-93

YD05



177
mm

YATO	L [mm]	
YT-7560	177	12/120

EN Glass cutter with diamond tip
PL Nóż do cięcia szkła z końcówką diamentową
DE Glasschneider mit Diamantspitze
RU Стеклорез с алмазным наконечником
CZ Nůž na sklo s diamentovou koncovkou
HU Üvegágó kés gyémánt fejfel

RO Diamant sticlă
FR Coupe-verre à pointe de diamant
IT Tagliavetro con punta di diamante
ES Cortador de vidrio con punta de diamante
CN 玻璃刮刀

175
mm



YATO	L [mm]	
YT-37390	175	6/240

EN Spare blades
PL Ostrza zapasowe
DE Abbrechklingen
RU Лезвия для универсальных ножей
CZ Lomené ostří náhradní
HU Törhető tartalékpenge
RO Lame de rezervă rupte
FR Lame sécables pour le cutter
IT Lame di ricambio
ES Filo partido de recambio
CN 实用刀片

10
PCS

61x33
x0.5
mm

SK5

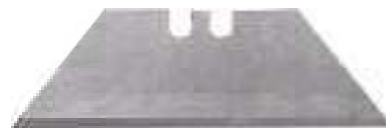

YATO	Blade size / Rozmiar ostrza [mm]	
YT-7531	61x33x0.5	24/144

EN Spare blades
PL Ostrza zapasowe
DE Abbrechklingen
RU Лезвия для универсальных ножей
CZ Lomené ostří náhradní
HU Törhető tartalékpenge
RO Lame de rezervă rupte
FR Lame sécables pour le cutter
IT Lame di ricambio
ES Filo partido de recambio
CN 实用刀片

10
PCS

61x33
x0.5
mm

SK2



YATO	Blade size / Rozmiar ostrza [mm]	
YT-7527	61x33x0.5	24/144

EN Scissors
PL Nożyczki
DE Haushaltsschere
RU Ножницы
CZ Nůžky
HU Olló

RO Foarface
FR Ciseaux
IT Forbici
ES Tijeras
CN 剪刀

SS
STAINLESS STEEL
SZYŁA NIERDZEWNA



YATO	L [mm]	
YT-19763	170	12/120
YT-19764	190	12/120
YT-19765	215	12/120
YT-19766	245	12/120
YT-19767	300	12/120



178
mm

YATO	L [mm]	
YT-7561	178	12/120

EN 2-sided glass cutting tool
PL Dwustronny nóż do płytek ceramicznych i szkła
DE Doppelseitiger Fliesen- und Glasschneider
RU Двусторонний резак для керамической плитки и стекла
CZ Oboustranný nůž na keramické dlaždice a sklo
HU Kétoldalú csempé- és üvegágó kés
RO Instrument de tăiat sticlă cu 2 capete
FR Coupeur de carreaux et de verre à double face
IT Tagliarina reversibile per piastrelle e vetro
ES Cuchillo doble para baldosas cerámicas y vidrio
CN 玻璃刮刀

120
mm

2x
8mm

YG6X

1+2-SIDED
CUTTING
EDGE
1+2-STRONNE



YATO	L [mm]	
YT-37404	120	6/240

EN Glass cutter with 3 wheels
 PL Nóż do cięcia szkła z trzema kółkami
 DE Glasschneider mit drei Rädern
 RU Стеклопоез с тремя роликами
 CZ Nůž na sklo se třemi kolečky
 HU Üvegágó kés három tárcsával

RO Diamant sticlă cu 3 cutite
 FR Coupe-verre à 3 molettes
 IT Tagliavetro a 3 ruote
 ES Cortador de vidrio con tres ruedas
 CN 玻璃割刀

130 mm
 3x YG6X



YATO	L [mm]	
YT-37391	130	10/150

EN Rotary cutter
 PL Nóż z okrągłym ostrzem
 DE Rollschneider
 RU Нож с круглым лезвием
 CZ Nůž s kulatým ostrím
 HU Körpéngés kés

RO Cutter rotativ
 FR Couteau à lame ronde
 IT Coltello con lama circolare
 ES Cuchillo con filo redondo
 CN 割刀

45 mm ABS TPR SK5

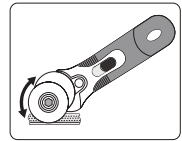

YATO	L [mm]	
YT-75360	45	12/96

EN Drywall board cutting tool with measuring tape
 PL Nóż do cięcia płyt gipsowo-kartonowych z miarą zwijaną
 DE Gipskartonschneider mit Rollmaß
 RU Нож для резы гипсокартона с рулеткой
 CZ Nůž na sádrokarton se svinovacím metrem
 HU Mérőszalagos gipszkartonvágó kés
 RO Instrument de tăiat plăci de gips-carton cu bandă de măsurare
 FR Coupeur pour plaque de plâtre avec ruban-mètre intégré
 IT Taglierina per cartongesso con metro a nastro
 ES Cortador de placa de yeso con cinta métrica
 CN 石膏板切割器



5m 19mm
 x5 BLADES

EN Double edge trimmer
 PL Dwustronny nóż do odcinania oklein
 DE Kantentrimmer
 RU Двусторонний нож для мебельной пленки
 CZ Orezávací nůž na hrany lamina
 HU Kétélű vágó
 RO Rindea pt. finisaje
 FR Couteau réversible pour bois de placage
 IT Doppio coltello
 ES Cuchillo de doble filo para cortar chapas de madera
 CN 双边刨子



13-25 mm 2-SIDED CUTTING EDGE 1-2-STRONNE SK5



YATO	L [mm]	
YT-5710	13-25	6/48

YATO	
YT-31350	30

EN Carving knife set
 PL Zestaw nożyków
 DE Klingensatz
 RU Набор резцов
 CZ Sada nožíků
 HU Késkészlet
 RO Set cutite prelucrare lemn
 FR Sculpture ensemble de couteau
 IT Set di coltelli
 ES Juego de cuchillas
 CN 美工刀



14 PCS HRC 60 T10 STEEL STAL AI HANDLE UCHWYT SOFT GRIP MIEKKI UCHWYT

EN Automatic center punch
 PL Punktak automatyczny
 DE Automatischer Kömer
 RU Автоматический кернер
 CZ Automatické důlčiček
 HU Automatikus központ punci

RO Punctator automat
 FR Pointeau automatique
 IT Bulino automatico
 ES Centro automático punch
 CN 自动中心冲

125 mm



YATO	L [mm]	
YT-47160	125	12/72

YATO	
YT-75140	6/48

EN Carving knife set
 PL Zestaw nożyków
 DE Klingensatz
 RU Набор резцов
 CZ Sada nožíků
 HU Késkészlet
 RO Set cutite prelucrare lemn
 FR Sculpture ensemble de couteau
 IT Set di coltelli
 ES Juego de cuchillas
 CN 雕刻刀



16 PCS SK5

EN Scriber for glass, ceramics and metal
 PL Rysik do szkła, ceramiki i metalu
 DE Reißnadel für Glas, Keramik und Metall
 RU Штихель для стекла, керамики и металла
 CZ Rýsovací jehla na sklo, keramiku a kov
 HU Karctű üveghez, kerámiához és fémhez

RO Ac de trasat pt. sticlă, ceramică și metal
 FR Stylet verre, céramique et métal
 IT Penna di vetro ceramica metallo
 ES Trazador para vidrio, cerámica y metal
 CN 划线器

140 mm YG6X



YATO	L [mm]	
YT-3740	140	20/300

YATO	
YT-75370	4/24

EN Multifunction tool for drawing lines
 PL Przyrząd do trasowania linii równoległych
 DE Markierungswerkzeug für parallele Linien
 RU Устройство для разметки параллельных линий
 CZ Nástroj pro směřování rovnolehlých linií
 HU Párhuzamjelölő
 RO Instrument multifuncțional pt. desenarea liniilor
 FR Dispositif de marquage de lignes parallèles
 IT Strumento per disegnare linee parallele
 ES Trazador de arco lineal
 CN 木工划线器



SS STAINLESS STEEL STAHL MERCEENNA AI

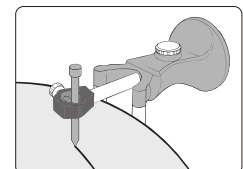

EN Adjustable automatic center punch
 PL Punktak automatyczny regulowany
 DE Automatischer Kömer mit regelbare Schlagkraft
 RU Регулируемое автоматическое кернер
 CZ Nastavitelné automatické důlčiček
 HU Automatikus központ punci

RO Punctator ajustabil automat
 FR Pointeau automatique réglable
 IT Bulino automatico regolabile
 ES Ajustable centro automático punch
 CN 可调中心冲

125 mm



YATO	L [mm]	
YT-47161	125	12/72

YATO	
YT-70730	20

EN Leather punch
PL Przebijak do skóry
DE Lederlocher
RU Круглый пробойник для кожи
CZ Průbojník na kůži
HU Bőryukasztó
RO Preducele
FR Perçoirs à cuir
IT Punteruolo per pelle
ES Perforar en piel
CN 皮带冲

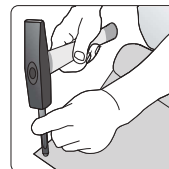

YATO	Ø [mm]	Box
YT-35850	2	20/100
YT-35851	3	20/100
YT-35852	4	20/100
YT-35853	5	20/100
YT-35854	6	20/100
YT-35855	7	20/100
YT-35856	8	20/100
YT-35857	9	20/100

YATO	Ø [mm]	Box
YT-35858	10	20/100
YT-35859	11	20/100
YT-35860	12	20/100
YT-35861	13	20/100
YT-35862	14	20/100
YT-35863	15	20/100
YT-35864	16	20/100
YT-35865	17	20/100

YATO	Ø [mm]	Box
YT-35866	18	20/100
YT-35867	19	20/80
YT-35868	20	20/80
YT-35869	21	20/60
YT-35870	22	20/80
YT-35871	23	10/50
YT-35872	24	20/60
YT-35873	25	20/60

EN Punch set
PL Przebijaki do skóry
DE Lederlocher-set
RU Набор пробойников для кожи
CZ Sada průbojníků na kůži
HU Bőryukasztó készlet
RO Set preducele
FR Kit de perçoirs à cuir
IT Set di punzoni
ES Juego de perforar en piel
CN 皮带冲组套

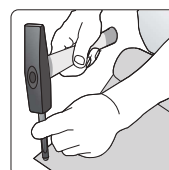

3
PCS

4
PCS

YATO	Ø [mm]	Box
YT-35881	6, 8, 10	20/120

YATO	Ø [mm]	Box
YT-35880	2, 3, 4, 5	20/120

EN Punch set
PL Przebijaki do skóry
DE Lederlocher-set
RU Набор пробойников для кожи
CZ Sada průbojníků na kůži
HU Bőryukasztó készlet
RO Set preducele
FR Kit de perçoirs à cuir
IT Set di punzoni
ES Juego de perforar en piel
CN 冲孔器组套

9
PCS



YATO	Ø [mm]	Box
YT-3590	2.5, 3, 4, 5, 6, 7, 8, 9, 10	50

EN Punch set
PL Przebijaki do skóry
DE Lederlocher-set
RU Набор пробойников для кожи
CZ Sada průbojníků na kůži
HU Bőryukasztó készlet
RO Set preducele
FR Kit de perçoirs à cuir
IT Set di punzoni
ES Juego de perforar en piel
CN 冲孔器组套

15
PCS



YATO	Ø [mm]	Box
YT-3591	2, 2.5, 3.2, 4, 4.8, 5.5, 6.4, 8, 9.5, 11.1, 12.7, 14, 15.8, 19, 22	10

EN Window scraper CZ Škrábák na skla IT Coltellino con lama trapezoidale
 PL Skrobak do szyby HU Kaparó üveghéz ES Rascador de cristales
 DE Fensterabstreicher RO Răzuitor pt. geamuri CN 玻璃刮刀
 RU Скребок для стекла FR Gratte-givre



300 mm

390-600 mm

TELESCOPIC HANDLE
 UCHWYT
 TELESKOPOWY

AI

YATO	L [mm]	
YT-7550	300	10/60

YATO	L [mm]	
YT-7551	390-600	10/60

EN Floor scraper RU Скребок для полов RO Racleta pt. podea ES Rascador para suelos
 PL Skrobak do podłóg CZ Škrabka na podlahu FR Racleur à plancher CN 地板铲刀
 DE Bodenabstreifer HU Padlókaparó IT Raschietto per pavimenti



65Mn

AI



350 mm

Fitting blades: YT-52843
 Pasujące ostrza: YT-52843

500 mm

Fitting blades: YT-52843
 Pasujące ostrza: YT-52843

YATO	L [mm]	
YT-52840	350	6/12

YATO	L [mm]	
YT-52841	500	2/12

EN Spare blades RU Запасные лезвия RO Lame de rezerva ES Cuchillas de repuesto
 PL Ostrza zapasowe CZ Náhradní ostří FR Lames de rechange CN 刀片
 DE Ersatzklingen HU Pótkések IT Lame di ricambio

5 PCS



1.5 mm

65Mn



For YT-52840, YT-52841
 Dla YT-52840, YT-52841

YATO		
YT-52843		10

EN Sliding hammer with scraper RO Ciocan inertial cu răzuitor
 PL Młot bezwładnościowy ze skrobakiem FR Impact grattoir
 DE Auswirkungen Schaber IT Martello inerziale con raschiatore
 RU Ударный скребок ES Raspador de impacto
 CZ Škrabka CN 冲击铲刀
 HU Kaparó eszköz



TELESCOPIC HANDLE
 UCHWYT
 TELESKOPOWY

T



YATO	L [mm]	
YT-52850	580-820	6

EN Scraper RU Цикля RO Răzuitor ES Raspador
 PL Cykлина CZ Škrabka na parkety FR Grattoir CN 油漆刮刀
 DE Ziehklinge HU Simitógyalu IT Raschietto per legno

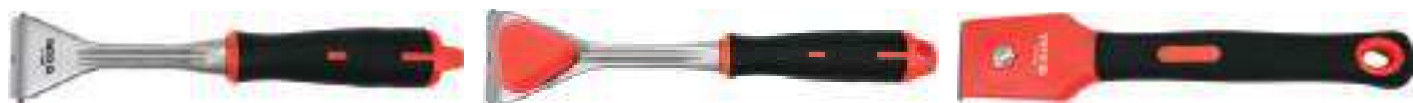

YATO	L [mm]	Blade length / Długość ostrza [mm]	
YT-75460	260	52	10/60

YATO	L [mm]	Blade length / Długość ostrza [mm]	
YT-75461	290	62	12/48

YATO	L [mm]	Blade length / Długość ostrza [mm]	
YT-75464	200	30	10/50
YT-75465	220	40	10/50
YT-75467	270	65	6/24

EN Prybar scraper set
PL Zestaw skrobaków ze stali nierdzewnej
DE Edelstahl-Schaber-Set
RU Набор скребков из нержавеющей стали
CZ Sada škrabek z nerezové oceli
HU Kaparókészlet rozsdamentes acélból
RO Set de raclete
FR Ensemble de racleurs en acier inoxydable
IT Set di raschietti in acciaio inox
ES Juego de raspadores de acero inoxidable
CN 铲刀

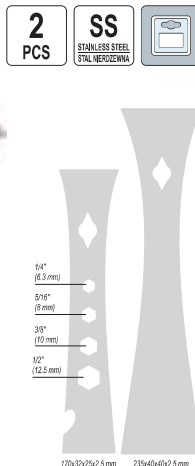

EN Pry bar scraper set
PL Zestaw łomów i skrobaków
DE Brecheisen Schaber
RU Ломы скребки
CZ Škrabky páčidla
HU Feszítóvas kaparó
RO Set leviere
FR Pieds-de-biche et grattoirs
IT Piedi di porco raschietti
ES Palancas raspadores
CN 撬棍



YATO	[mm]	
YT-52860	170x32x25, 235x40x40	12/48

YATO	[mm]	
YT-52863	135x14, 182x25, 240x42	12/48

EN Cabinet scraper set
PL Zestaw skrobaków ręcznych nierdzewnych
DE Edelstahl-Handschaber-Set
RU Набор ручных нержавеющей скребков
CZ Sada nerezových ručních škrabek
HU Kézi rozsdamentes kaparókészlet
RO Set raclete
FR Ensemble de grattoirs à main en acier inoxydable
IT Set di raschietti manuali inox
ES Juego de raspadores manuales inoxidables
CN 刮板

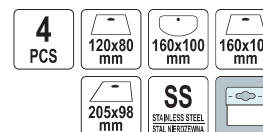

YATO	[mm]	
YT-52788	100x160, 120x80, 160x100, 205x98	20/40

EN Block plane
PL Metalowy strug do drewna
DE Metallhobel für Holz
RU Металлический рубанок по дереву
CZ Kovový hoblík do dřeva
HU Fémgyalu
RO Rindea
FR Rabot à bois en métal
IT Piaalla metallica per legno
ES Cepillo metálico para madera
CN 木工铁刨



YATO	Blade width / Szerokość ostrza [mm]	L [mm]	
YT-62900	44	235	24

EN Block plane with two blades
PL Metalowy strug dwuostrzowy
DE Metallhobel mit Doppelreisen
RU Металлический рубанок с обоюдоострым лезвием
CZ Kovový hoblík s dvojitým ostrím
HU Kétpengés fémgyalu
RO Rindea cu 2 lame
FR Rabot en métal à deux lames
IT Piaalla metallica a due lame
ES Cepillo metálico de doble hoja
CN 墙刨



YATO	Blade width / Szerokość ostrza [mm]	L [mm]	
YT-62907	23	235	12/48

EN Chamfering planer
PL Strug do fazowania krawędzi
DE Kantenhobel
RU Рубанок для снятия фаски
CZ Nástroj na srážení hran
HU Letörési vágógép
RO Rindea pt, testre
FR Rabot à chanfreiner
IT Piaalla per smusso
ES Cepillo para biselar bordes
CN 倒角刨

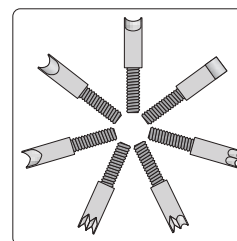

YATO	Blade width / Szerokość ostrza [mm]	L [mm]	
YT-62910	9	155	24

EN Steel file
 PL Piłnik do metalu
 DE Werkstatt-Feile
 RU Напильник слесарный
 CZ Zámeňický pilník
 HU Lakatos reszelő
 RO Pila de lăcătuşerie
 FR Lime à métal
 IT Lime per metallo
 ES Lima para metal
 CN 扁挫

#1 #2 #3 150 mm 200 mm 250 mm 300 mm T12



YATO	[#]	L [mm]	☐
YT-62228	1	150	20/80
YT-62229	1	200	20/80
YT-6223	1	250	20/80
YT-62231	1	300	10/40
YT-6180	2	150	20/80
YT-6185	2	200	20/80
YT-6228	2	250	20/80
YT-6190	2	300	10/40
YT-62328	3	150	20/80
YT-62329	3	200	20/80
YT-6233	3	250	20/80
YT-62331	3	300	10/40

YATO	[#]	L [mm]	☐
YT-62238	1	150	20/80
YT-62239	1	200	20/80
YT-6224	1	250	20/80
YT-62241	1	300	10/40
YT-6181	2	150	20/80
YT-6186	2	200	20/80
YT-6229	2	250	20/80
YT-6191	2	300	10/40
YT-62243	3	150	20/80
YT-62244	3	200	20/80
YT-62245	3	250	20/80
YT-62246	3	300	10/40



YATO	[#]	L [mm]	☐
YT-62248	1	150	20/80
YT-62249	1	200	20/80
YT-6225	1	250	20/80
YT-62251	1	300	10/40
YT-6182	2	150	20/80
YT-6187	2	200	20/80
YT-6230	2	250	20/80
YT-6192	2	300	10/40
YT-62338	3	150	20/80
YT-62339	3	200	20/80
YT-6234	3	250	20/80
YT-62341	3	300	10/40

YATO	[#]	L [mm]	☐
YT-62258	1	150	20/80
YT-62259	1	200	20/80
YT-6226	1	250	20/80
YT-62261	1	300	10/40
YT-6183	2	150	20/80
YT-6188	2	200	20/80
YT-6231	2	250	20/80
YT-6193	2	300	10/40
YT-62348	3	150	20/80
YT-62349	3	200	20/80
YT-6235	3	250	20/80
YT-62351	3	300	10/40

YATO	[#]	L [mm]	☐
YT-62268	1	150	20/80
YT-62269	1	200	20/80
YT-6227	1	250	20/80
YT-62271	1	300	10/40
YT-6184	2	150	20/80
YT-6189	2	200	20/80
YT-6232	2	250	20/80
YT-6194	2	300	10/40
YT-62358	3	150	20/80
YT-62359	3	200	20/80
YT-6236	3	250	20/80

EN Steel file set
 PL Piłniki do metalu
 DE Werkstatt-Feilen
 RU Набор напильников слесарных

CZ Zámeňické pilníky
 HU Lakatos reszelő
 RO Pile de lăcătuşerie
 FR Set de limes à métal

IT Lime per metallo
 ES Juego de limas para metal
 CN 钢挫组套

#1 #2 #3
 250 mm T12



3 PCS

5 PCS

5 PCS

YATO	[#]	☐
YT-6237	2	10/20

YATO	[#]	☐
YT-6238	1, 2	5/10

YATO	[#]	☐
YT-6239	3	5/10

EN Needle file set
PL Zestaw pilników iglaków
DE Nadelfeilsatz
RU Набор напильников надфили

CZ Sada jehlových pilníků
HU Tűreszelő készlet
RO Set pile conice
FR Set de limes

IT Set di lime e lime ad ago
ES Juego de limas de aguja
CN 什锦锉组套

6
PCS

GCr15



YATO	Working length / Długość robocza [mm]	[mm]	
YT-6160	65	3x140	50/200

YATO	Working length / Długość robocza [mm]	[mm]	
YT-6161	75	4x160	25/100

YATO	Working length / Długość robocza [mm]	[mm]	
YT-6162	85	5x180	25/100

EN Needle file set
PL Zestaw pilników iglaków
DE Nadelfeilsatz
RU Набор напильников надфили

CZ Sada jehlových pilníků
HU Tűreszelő készlet
RO Set pile conice
FR Set de limes

IT Set di lime e lime ad ago
ES Juego de limas de aguja
CN 什锦锉组套

10
PCS

GCr15



YATO	Working length / Długość robocza [mm]	[mm]	
YT-6163	65	3x140	25/100

YATO	Working length / Długość robocza [mm]	[mm]	
YT-6164	75	4x160	25/100
YT-6165	85	5x180	25/50

EN Diamond needle file
PL Pilnik iglak diamentowy
DE Diamant-Nadelfeile
RU Надфиль алмазный

CZ Diamantový jehlový pilník
HU Gyémánt tűreszelő
RO Pila diamantata
FR Lime diamant

IT Lima ad ago diamantata
ES Lima de aguja adiamantada
CN 金刚石平头扁锉

G150



YATO	Grit / Ziarnistość	Coating length / Długość nasypu [mm]	[mm]	
YT-6140	G150	52	3x140	120/1200
YT-6147	G150	50	4x160	80/800
YT-6152	G150	70	180	45/450

YATO	Grit / Ziarnistość	Coating length / Długość nasypu [mm]	[mm]	
YT-6141	G150	50	3x140	120/1200
YT-6148	G150	50	4x160	80/800
YT-6153	G150	70	5x180	45/450

YATO	Grit / Ziarnistość	Coating length / Długość nasypu [mm]	[mm]	
YT-6142	G150	50	3x140	120/1200
YT-6149	G150	50	4x160	80/800
YT-6154	G150	70	5x180	45/450

EN Diamond needle file set
 PL Zestaw pilników diamentowych igłaków
 DE Diamant-Nadelfeileinsatz
 RU Набор надфилей алмазных

CZ Sada diamentových jehlových pilníků
 HU Gyémánt tűreszelő készlet
 RO Set pile diamentate
 FR Set de limes diamant

IT Set lime ad ago diamantate
 ES Juego de limas de aguja adiamantadas
 CN 金刚石整形锉

G150

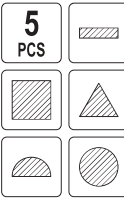
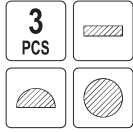

YATO	Grit / Ziarnistość	Coating length / Długość nasypu [mm]	[mm]	
YT-6143	G150	50	3x140	40/400
YT-6150	G150	50	4x160	30/300
YT-6155	G150	70	5x180	15/150

YATO	Grit / Ziarnistość	Coating length / Długość nasypu [mm]	[mm]	
YT-6156	G150	70	180	10/100

EN Diamond needle file set
 PL Zestaw pilników diamentowych igłaków
 DE Diamant-Nadelfeileinsatz
 RU Набор надфилей алмазных

CZ Sada diamentových jehlových pilníků
 HU Gyémánt tűreszelő készlet
 RO Set pile diamentate
 FR Set de limes diamant

IT Set lime ad ago diamantate
 ES Juego de limas de aguja adiamantadas
 CN 金刚石整形锉

10 PCS

G150

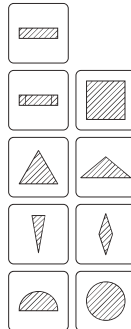
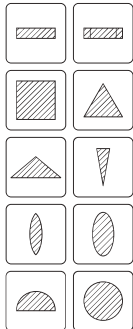

YATO	Grit / Ziarnistość	Coating length / Długość nasypu [mm]	[mm]	
YT-6144	G150	50	3x140	12/120

YATO	Grit / Ziarnistość	Coating length / Długość nasypu [mm]	[mm]	
YT-6145	G150	25	3x140	12/120

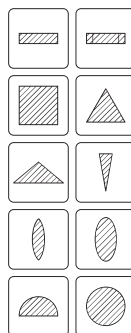
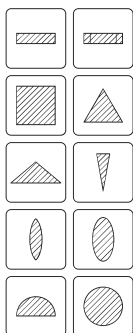

YATO	Grit / Ziarnistość	Coating length / Długość nasypu [mm]	[mm]	
YT-6146	G150	30	3x140	12/120

YATO	Grit / Ziarnistość	Coating length / Długość nasypu [mm]	[mm]	
YT-6151	G150	50	4x160	9/90

EN Diamond sharpening file
PL Oseka diamentowa - pilnik
DE Diamant-Schärfen-Datei
RU Напильник алмазный
CZ Diamantový pilník
HU Gyémánt reszelők

RO Pila diamentata pt. ascuțit
FR Fichier de diamant
IT Pietra diamentata - lima
ES Archivo de afilado de diamante
CN 金刚石锉刀



YATO	Grit / Ziarnistość	L [mm]	
YT-76080	G240, G400	250	12/48

EN Diamond whetstone
PL Oseka diamentowa - blok
DE Diamant Schleifstein
RU Алмазный брусок
CZ Diamond brousek
HU Kétoldalú gyémánt fenékö
RO Pietra abraziva diamentata
FR Affiloir diamanté
IT Pietra diamentata
ES Piedra de afilar diamentada
CN 金刚石磨刀石



YATO	Grit / Ziarnistość	Coating length / Długość nasypu [mm]	[mm]	
YT-76085	G300	50	4x150	10/60
YT-76086	G400	50	4x150	10/60
YT-76087	G600	50	4x150	10/60

EN Diamond grinding wheel dresser
PL Przyrząd diamentowy do wyrównywania tarcz szlifierskich
DE Diamant-Schleifrad-Dresser
RU Брусок алмазный для выравнивания абразивных дисков
CZ Diamantový ohrnovávač brusných kotoučů
HU Gyémánt kölelhúzó
RO Diamant pt. rectifi care pietre polizor
FR Diamant meule roue pierre dresse
IT Utensile diamentato per levigare le mole
ES Muelas tocador con diamante plana
CN 砂轮修正器



YATO	
YT-61395	20/200

EN Wood rasp
PL Tamnik do drewna
DE Holzraspel
RU Рапилия для дерева

CZ Rašple do dřeva
HU Fareszelő
RO Raspe
FR Lime à bois

IT Lime per legno
ES Escarpelo para madera
CN 木工挫 - 半圆



YATO	L [mm]		YATO	L [mm]		YATO	L [mm]	
YT-6220	250	12/72	YT-6219	250	12/72	YT-6221	250	12/72

EN Wood rasp set
PL Tamniki do drewna
DE Holzraspelsatz
RU Рапилия для дерева
CZ Sada rašplí do dřeva
HU Fareszelő készlet

RO Set raspe
FR Set de limes à bois
IT Set di lime per legno
ES Juego de escarpelos para madera
CN 木工挫组套

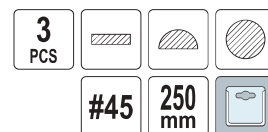

YATO	L [mm]	
YT-6222	250	5/20

EN Rasp for plaster
PL Tamnik do gipsu
DE Gipskartonplatten Rasp
RU Рапилия для гипсокартона
CZ Rašple pro omítky
HU Reszelt vakolat
RO Rindea
FR Râpe pour plâtre
IT Raspa per gesso
ES Eliminador de yeso
CN 挫刨

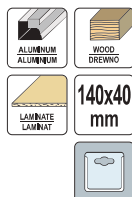

YATO	Working length / Długość robocza [mm]	Working width / Szerokość robocza [mm]	
YT-61678	140	40	15/60

EN Blade for rasp
PL Ostrze zapasowe do tamnika
DE Sägeblatt raspel
RU Лезвие для рапилия по гипсокартону
CZ Čepel do škrabacích
HU Penge reszelő
RO Lama pt. rasp
FR Lame râpe
IT Lama di ricambio per raspa
ES Hoja para raspar
CN 挫刨刀片

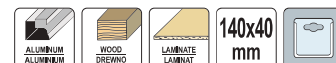

For YT-61678
Dla YT-61678

YATO	Working length / Długość robocza [mm]	Working width / Szerokość robocza [mm]	
YT-61679	140	40	10/120

EN Rasp for plaster
PL Tamnik do gipsu
DE Gipskartonplatten Rasp
RU Рапилия для гипсокартона
CZ Rašple pro omítky
HU Reszelt vakolat
RO Rindea
FR Râpe pour plâtre
IT Raspa per gesso
ES Eliminador de yeso
CN 挫刨

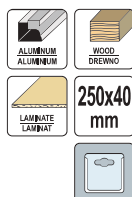

YATO	Working length / Długość robocza [mm]	Working width / Szerokość robocza [mm]	
YT-61680	250	40	15/60

EN Blade for rasp
PL Ostrze zapasowe do tamnika
DE Sägeblatt raspel
RU Лезвие для рапилия по гипсокартону
CZ Čepel do škrabacích
HU Penge reszelő
RO Lama pt. rasp
FR Lame râpe
IT Lama di ricambio per raspa
ES Hoja para raspar
CN 挫刨刀片



For YT-61680
Dla YT-61680

YATO	Working length / Długość robocza [mm]	Working width / Szerokość robocza [mm]	
YT-61681	250	40	30/120

EN Sand paper
 PL Papier ścierny
 DE Schleifpapier
 RU Наждачная бумага
 CZ Smrkový papír
 HU Csiszolópapír

RO Hârtie abrazivă
 FR Papier abrasif
 IT Carta vetrata
 ES Papel de lija
 CN 砂纸



- Application: paint, lacquer, filler, wood
- Abrasive: aluminium oxide
- Bond: synthetic resin
- Coating: semi-open
- Zastosowanie: farby, lakiery, szpachle, drewno
- Ściemiwo: tlenek glinu
- Spoivo: żywica syntetyczna
- Nasyp: półotwarty

YATO	Grit / Ziarnistość	[mm]	pcs / szt.	
YT-8350	P40	230x280	50	500
YT-8351	P60	230x280	50	500
YT-8352	P80	230x280	50	500
YT-8353	P100	230x280	50	500
YT-8354	P120	230x280	50	500
YT-8355	P150	230x280	50	500
YT-8356	P180	230x280	50	500
YT-8357	P220	230x280	50	500
YT-8358	P240	230x280	50	500

EN Sand paper
 PL Papier ścierny
 DE Schleifpapier
 RU Наждачная бумага
 CZ Smrkový papír
 HU Csiszolópapír

RO Hârtie abrazivă
 FR Papier abrasif
 IT Carta vetrata
 ES Papel de lija
 CN 砂纸



- Application: paint, lacquer, filler, wood
- Abrasive: aluminium oxide
- Bond: synthetic resin
- Coating: semi-open
- Zastosowanie: farby, lakiery, szpachle, drewno
- Ściemiwo: tlenek glinu
- Spoivo: żywica syntetyczna
- Nasyp: półotwarty

YATO	Grit / Ziarnistość	Size / Rozmiar	
YT-8449	P40	93 mm x 5 m	12/48
YT-8450	P60	93 mm x 5 m	12/48
YT-8451	P80	93 mm x 5 m	12/48
YT-8452	P100	93 mm x 5 m	12/48
YT-8453	P120	93 mm x 5 m	12/48
YT-8454	P150	93 mm x 5 m	12/48
YT-8455	P180	93 mm x 5 m	12/48
YT-8456	P240	93 mm x 5 m	12/48

EN Sand paper
 PL Papier ścierny
 DE Schleifpapier
 RU Наждачная бумага
 CZ Smrkový papír
 HU Csiszolópapír

RO Hârtie abrazivă
 FR Papier abrasif
 IT Carta vetrata
 ES Papel de lija
 CN 砂纸



- Application: paint, lacquer, filler, wood
- Abrasive: aluminium oxide
- Bond: synthetic resin
- Coating: semi-open
- Zastosowanie: farby, lakiery, szpachle, drewno
- Ściemiwo: tlenek glinu
- Spoivo: żywica syntetyczna
- Nasyp: półotwarty

YATO	Grit / Ziarnistość	Size / Rozmiar	
YT-8441	P60	115 mm x 5 m	12/48
YT-8442	P80	115 mm x 5 m	12/48
YT-8443	P100	115 mm x 5 m	12/48
YT-8444	P120	115 mm x 5 m	12/48
YT-8445	P150	115 mm x 5 m	12/48
YT-8446	P180	115 mm x 5 m	12/48
YT-8447	P240	115 mm x 5 m	12/48
YT-8448	P320	115 mm x 5 m	12/48

EN Sand paper
 PL Papier ścierny
 DE Schleifpapier
 RU Наждачная бумага
 CZ Smrkový papír
 HU Csiszolópapír

RO Hârtie abrazivă
 FR Papier abrasif
 IT Carta vetrata
 ES Papel de lija
 CN 防水砂纸



- Application: paint, lacquer, filler
- Abrasive: silicon carbide
- Bond: synthetic resin
- Coating: closed
- Zastosowanie: farby, lakiery, szpachle
- Ściemiwo: węgiel krzemu
- Spoivo: żywica syntetyczna
- Nasyp: pełny

YATO	Grit / Ziarnistość	[mm]	pcs / szt.	
YT-8400	P60	230x280	50	500
YT-8401	P80	230x280	50	500
YT-8402	P100	230x280	50	500
YT-8403	P120	230x280	50	500
YT-8404	P150	230x280	50	500

EN Sand paper
 PL Papier ścierny
 DE Schleifpapier
 RU Наждачная бумага
 CZ Smrkový papír
 HU Csiszolópapír

RO Hârtie abrazivă
 FR Papier abrasif
 IT Carta vetrata
 ES Papel de lija
 CN 防水砂纸



- Application: paint, lacquer, filler
- Abrasive: silicon carbide
- Bond: synthetic resin
- Coating: closed
- Zastosowanie: farby, lakiery, szpachle
- Ściemiwo: węgiel krzemu
- Spoivo: żywica syntetyczna
- Nasyp: pełny

YATO	Grit / Ziarnistość	[mm]	pcs / szt.	
YT-8405	P180	230x280	50	500
YT-8406	P220	230x280	50	500
YT-8407	P240	230x280	50	500
YT-8408	P280	230x280	50	500
YT-8409	P320	230x280	50	500
YT-8410	P360	230x280	50	500
YT-8411	P400	230x280	50	500

EN Sand paper
 PL Papier ścierny
 DE Schleifpapier
 RU Наждачная бумага
 CZ Smrkový papír
 HU Csiszolópapír

RO Hârtie abrazivă
 FR Papier abrasif
 IT Carta vetrata
 ES Papel de lija
 CN 防水砂纸



- Application: paint, lacquer, filler
- Abrasive: silicon carbide
- Bond: synthetic resin
- Coating: closed
- Zastosowanie: farby, lakiery, szpachle
- Ściemiwo: węgiel krzemu
- Spoivo: żywica syntetyczna
- Nasyp: pełny

YATO	Grit / Ziarnistość	[mm]	pcs / szt.	
YT-8412	P500	230x280	50	500
YT-8413	P600	230x280	50	500
YT-8414	P800	230x280	50	500
YT-8415	P1000	230x280	50	500
YT-8416	P1200	230x280	50	500
YT-8417	P1500	230x280	50	500
YT-8418	P2000	230x280	50	500

EN Abrasive cloth sheet
PL Płótno ściernie arkusz
DE Schleifgewebe Blatt
RU Шлифовальное полотно
CZ Brusné plátno
HU Csiszolóvászon lap

RO Coli panza abraziva
FR Tissu abrasif
IT Carta vetrata
ES Hojas de pano abrasivo
CN 砂布



- Application: metal, wood
- Abrasive: aluminium oxide
- Bond: semi-resin
- Coating: closed

- Zastosowanie: metal, drewno
- Ścierniwo: tlenek glinu
- Spoiwo: żywica
- Nasyp pełny

YATO	Grit / Ziarnistość	[mm]	pcs / szt.	
YT-83160	P36	230x280	50	250
YT-83161	P40	230x280	50	250
YT-83162	P60	230x280	50	250
YT-83163	P80	230x280	50	250
YT-83164	P100	230x280	50	250
YT-83165	P120	230x280	50	500
YT-83166	P150	230x280	50	500
YT-83167	P180	230x280	50	500
YT-83168	P220	230x280	50	500
YT-83169	P240	230x280	50	500

EN Abrasive mesh
PL Siatka ścierna
DE Schleifgitter
RU Абразивная сетка
CZ Brusná sítká
HU Csiszolóháló

RO Plasă abrazivă
FR Disque abrasif à maille
IT Rete abrasiva
ES Malla abrasiva
CN 网状砂纸

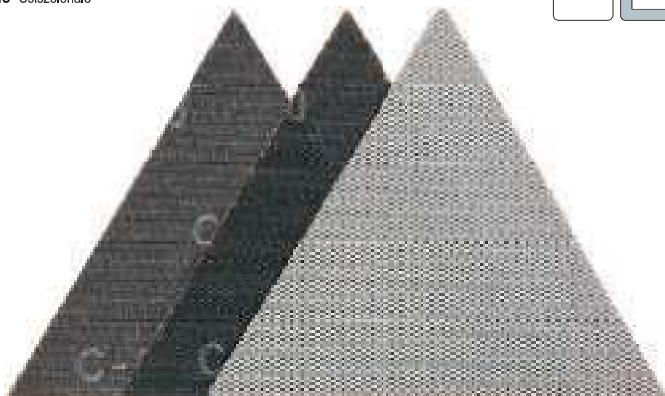

YATO	Grit / Ziarnistość	[mm]	pcs / szt.	
YT-846113	P80	280x280x280	3	100
YT-846133	P120	280x280x280	3	100
YT-846153	P180	280x280x280	3	100

EN Endless sanding belt
PL Taśma ścierna bezkońcowa
DE Schleifband
RU Шлифовальные ленты

CZ Brusný pás
HU Csiszoló szalag
RO Bandă de pânză
FR Bande abrasive sans fin

IT Nastro abrasivo senza fine
ES Pano abrasivo cinturón
CN 砂带



- Application: metal, wood
- Abrasive: aluminium oxide
- Bond: synthetic resin
- Coating: closed

- Zastosowanie: metal, drewno
- Ścierniwo: tlenek glinu
- Spoiwo: żywica syntetyczna
- Nasyp pełny

YATO	Grit / Ziarnistość	[mm]	pcs / szt.	
YT-09747	P60	20x520	10	50
YT-09748	P80	20x520	10	50
YT-09749	P100	20x520	10	50
YT-09750	P120	20x520	10	50

EN Abrasive cloth roll
PL Płótno ściernie rolka
DE Schleifgewebe Rolle
RU Рулон-шлифовальное полотно
CZ Brusné plátno role
HU Csiszolóvászon tekercs

RO Rola panza abraziva
FR Tissu abrasif rouleau
IT Carta vetrata rotolo
ES Rollo de pano abrasivo
CN 砂布



- Application: metal, wood
- Abrasive: aluminium oxide
- Bond: semi-resin
- Coating: closed

- Zastosowanie: metal, drewno
- Ścierniwo: tlenek glinu
- Spoiwo: żywica
- Nasyp pełny

YATO	Grit / Ziarnistość	Size / Rozmiar	
YT-83183	P60	150 mm x 50 m	2
YT-83184	P80	150 mm x 50 m	2
YT-83185	P100	150 mm x 50 m	2
YT-83186	P120	150 mm x 50 m	2
YT-83187	P150	150 mm x 50 m	2
YT-83188	P180	150 mm x 50 m	2

EN Endless sanding belt
PL Taśma ścierna bezkońcowa
DE Schleifband
RU Шлифовальные ленты
CZ Brusný pás
HU Csiszoló szalag

RO Bandă de pânză
FR Bande abrasive sans fin
IT Nastro abrasivo senza fine
ES Pano abrasivo cinturón
CN 砂带



- Application: metal, wood
- Abrasive: aluminium oxide
- Bond: synthetic resin
- Coating: closed

- Zastosowanie: metal, drewno
- Ścierniwo: tlenek glinu
- Spoiwo: żywica syntetyczna
- Nasyp pełny

YATO	Grit / Ziarnistość	[mm]	pcs / szt.	
YT-09743	P60	10x330	10	100
YT-09744	P80	10x330	10	100
YT-09745	P100	10x330	10	100
YT-09746	P120	10x330	10	100

EN No end abrasive band
PL Pas ścierny bezkońcowy
DE Schleifband
RU Шлифлента бесконечная

CZ Brusný pás
HU Csiszoló szalag
RO Curea abraziva
FR Bande abrasive sans fin

IT Nastro abrasivo senza fine
ES Banda abrasiva sin fin
CN 砂带



- Application: metal, wood
- Abrasive: aluminium oxide
- Bond: synthetic resin
- Coating: closed

- Zastosowanie: metal, drewno
- Ścierniwo: tlenek glinu
- Spoiwo: żywica syntetyczna
- Nasyp pełny

YATO	Grit / Ziarnistość	[mm]	pcs / szt.	
YT-83221	P40	75x457	5	20/60
YT-83222	P60	75x457	5	20/60
YT-83223	P80	75x457	5	20/60
YT-83224	P100	75x457	5	20/60
YT-83225	P120	75x457	5	20/60

EN No end abrasive band
 PL Pas ścierny bezkońcowy
 DE Schleifband
 RU Шлифлента бесконечная

CZ Brusný pás
 HU Csiszoló szalag
 RO Curea abraziva
 FR Bande abrasive sans fin

IT Nastro abrasivo senza fine
 ES Banda abrasiva sin fin
 CN 砂带



- Application: metal, wood
- Abrasive: aluminium oxide
- Bond: synthetic resin
- Coating: closed
- Zastosowanie: metal, drewno
- Ścierniwo: tlenek glinu
- Spoiwo: żywica syntetyczna
- Nasyp pełny

YATO	Grit / Ziarnistość	[mm]	pcs / szt.	
YT-83227	P36	75x533	5	20/60
YT-83228	P40	75x533	5	20/60
YT-83229	P60	75x533	5	20/60
YT-83230	P80	75x533	5	20/60
YT-83231	P100	75x533	5	20/60
YT-83232	P120	75x533	5	20/60
YT-83233	P150	75x533	5	20/60

EN No end abrasive band
 PL Pas ścierny bezkońcowy
 DE Schleifband
 RU Шлифлента бесконечная

CZ Brusný pás
 HU Csiszoló szalag
 RO Curea abraziva
 FR Bande abrasive sans fin

IT Nastro abrasivo senza fine
 ES Banda abrasiva sin fin
 CN 砂带



- Application: metal, wood
- Abrasive: aluminium oxide
- Bond: synthetic resin
- Coating: closed
- Zastosowanie: metal, drewno
- Ścierniwo: tlenek glinu
- Spoiwo: żywica syntetyczna
- Nasyp pełny

YATO	Grit / Ziarnistość	[mm]	pcs / szt.	
YT-83235	P40	100x610	5	20/60
YT-83236	P60	100x610	5	20/60
YT-83237	P80	100x610	5	20/60
YT-83238	P100	100x610	5	20/60
YT-83239	P120	100x610	5	20/60

EN Sponge with diamond surface
 PL Gąbka z powierzchnią diamentową
 DE Diamant-Schleifschwamm
 RU Губка алмазная прямая
 CZ Diamantová houčička pro leštění
 HU Gyémánt felületű szivacs
 RO Burete cu suprafata diamantata
 FR Éponge à surface diamantée
 IT Spugnetta con superficie diamantata
 ES Esponja para lijar a mano de diamante
 CN 金刚石打磨块

G60



YATO	Grit / Ziarnistość	
YT-76101	G60	50

EN Sponge with diamond surface
 PL Gąbka z powierzchnią diamentową
 DE Diamant-Schleifschwamm
 RU Губка алмазная прямая
 CZ Diamantová houčička pro leštění
 HU Gyémánt felületű szivacs
 RO Burete cu suprafata diamantata
 FR Éponge à surface diamantée
 IT Spugnetta con superficie diamantata
 ES Esponja para lijar a mano de diamante
 CN 金刚石打磨块

G100



YATO	Grit / Ziarnistość	
YT-76103	G100	50

EN Sponge with diamond surface
 PL Gąbka z powierzchnią diamentową
 DE Diamant-Schleifschwamm
 RU Губка алмазная прямая
 CZ Diamantová houčička pro leštění
 HU Gyémánt felületű szivacs
 RO Burete cu suprafata diamantata
 FR Éponge à surface diamantée
 IT Spugnetta con superficie diamantata
 ES Esponja para lijar a mano de diamante
 CN 金刚石打磨块

G200



YATO	Grit / Ziarnistość	
YT-76105	G200	50

EN Sponge with diamond surface
 PL Gąbka z powierzchnią diamentową
 DE Diamant-Schleifschwamm
 RU Губка алмазная прямая
 CZ Diamantová houčička pro leštění
 HU Gyémánt felületű szivacs
 RO Burete cu suprafata diamantata
 FR Éponge à surface diamantée
 IT Spugnetta con superficie diamantata
 ES Esponja para lijar a mano de diamante
 CN 金刚石打磨块

G400





YATO	Grit / Ziarnistość	
YT-76108	G400	50

EN Flap disc – regular shape
PL Ściernica listkowa talerzowa płaska
DE Fächerschleifscheibe gerade
RU Круг лепестковый тарельчатый
CZ Lamelový brusný kotouč
HU Lamellás csiszoló normál
RO Disc lamelar frontal
FR Disque à lamelles abrasives plat
IT Disco abrasivo per metallo
ES Discos de paño abrasivo
CN 百叶轮





- Application: metal
- Abrasive: aluminium oxide
- Bond: synthetic resin
- Backing: fibreglass
- Zastosowanie: metal
- Ścierniwo: tlenek glinu
- Spoiwo: żywica syntetyczna
- Podkład: włókno szklane

YATO 	Grit / Ziarnistość	Ø [mm]	Mounting hole diameter / Średnica mocowania [mm]	
YT-83271	P36	125	22.4	25/100
YT-83272	P40	125	22.4	25/100
YT-83273	P60	125	22.4	50/200
YT-83274	P80	125	22.4	50/200
YT-83275	P100	125	22.4	50/200
YT-83276	P120	125	22.4	50/200

EN Flap disc – depressed shape
PL Ściernica listkowa talerzowa wypukła
DE Fächerschleifscheibe gewölbt
RU Круг лепестковый тарельчатый
CZ Lamelový brusný kotouč - vypuklý
HU Lamellás csiszoló dombított
RO Disc lamelar frontal depresat
FR Disque à lamelles abrasives bombé
IT Disco abrasivo a centro depresso
ES Discos de paño abrasivo centro embutido
CN 百叶轮





- Application: metal
- Abrasive: aluminium oxide
- Bond: synthetic resin
- Backing: fibreglass
- Zastosowanie: metal
- Ścierniwo: tlenek glinu
- Spoiwo: żywica syntetyczna
- Podkład: włókno szklane

YATO 	Grit / Ziarnistość	Ø [mm]	Mounting hole diameter / Średnica mocowania [mm]	
YT-83291	P36	125	22.4	25/100
YT-83292	P40	125	22.4	25/100
YT-83293	P60	125	22.4	50/200
YT-83294	P80	125	22.4	50/200
YT-83295	P100	125	22.4	50/200
YT-83296	P120	125	22.4	50/200

EN Flap wheel with shaft
PL Ściernica listkowa trzpieniowa
DE Fächerschleifer mit Schaft
RU Круг лепестковый со шпинделем
CZ Lamelový kotouč s hřídelem
HU Legyező csiszoló csapos
RO Perie abraziva circulara cu tija
FR Disque à lamelles abrasives pivot
IT Ruote lamellari
ES Rueda laminar en tela abrasiva
CN 百叶轮





- Application: metal
- Abrasive: aluminium oxide
- Bond: synthetic resin
- Zastosowanie: metal
- Ścierniwo: tlenek glinu
- Spoiwo: żywica syntetyczna

YATO 	Grit / Ziarnistość	[mm]	
YT-83351	P40	40x20x6	10/60
YT-83352	P60	40x20x6	10/60
YT-83353	P80	40x20x6	10/60
YT-83354	P100	40x20x6	10/60
YT-83355	P120	40x20x6	10/60
YT-83356	P150	40x20x6	10/60

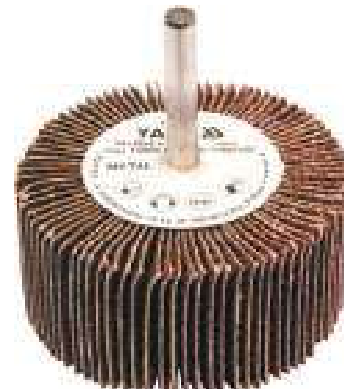
EN Flap wheel with shaft
PL Ściernica listkowa trzpieniowa
DE Fächerschleifer mit Schaft
RU Круг лепестковый со шпинделем
CZ Lamelový kotouč s hřídelem
HU Legyező csiszoló csapos
RO Perie abraziva circulara cu tija
FR Disque à lamelles abrasives pivot
IT Ruote lamellari
ES Rueda laminar en tela abrasiva
CN 百叶轮





- Application: metal
- Abrasive: aluminium oxide
- Bond: synthetic resin
- Zastosowanie: metal
- Ścierniwo: tlenek glinu
- Spoiwo: żywica syntetyczna

YATO 	Grit / Ziarnistość	[mm]	
YT-83361	P40	60x30x6	10/60
YT-83362	P60	60x30x6	10/60
YT-83363	P80	60x30x6	10/60
YT-83364	P100	60x30x6	10/60
YT-83365	P120	60x30x6	10/60
YT-83366	P150	60x30x6	10/60

EN Flap wheel with shaft
PL Ściernica listkowa trzpieniowa
DE Fächerschleifer mit Schaft
RU Круг лепестковый со шпинделем
CZ Lamelový kotouč s hřídelem
HU Legyező csiszoló csapos
RO Perie abraziva circulara cu tija
FR Disque à lamelles abrasives pivot
IT Ruote lamellari
ES Rueda laminar en tela abrasiva
CN 百叶轮





- Application: metal
- Abrasive: aluminium oxide
- Bond: synthetic resin
- Zastosowanie: metal
- Ścierniwo: tlenek glinu
- Spoiwo: żywica syntetyczna

YATO 	Grit / Ziarnistość	[mm]	
YT-83371	P40	80x30x6	10/60
YT-83372	P60	80x30x6	10/60
YT-83373	P80	80x30x6	10/60
YT-83374	P100	80x30x6	10/60
YT-83375	P120	80x30x6	10/60
YT-83376	P150	80x30x6	10/60

EN Flap wheel with shaft
PL Ściernica listkowa trzpieniowa
DE Fächerschleifer mit Schaft
RU Круг лепестковый со шпинделем
CZ Lamelový kotouč s hřídelem
HU Legyező csiszoló csapos
RO Perie abraziva circulara cu tija
FR Disque à lamelles abrasives pivot
IT Ruote lamellari
ES Rueda laminar en tela abrasiva
CN 百叶轮



- Application: metal
- Abrasive: aluminium oxide
- Bond: synthetic resin
- Zastosowanie: metal
- Ścierniwo: tlenek glinu
- Spoiwo: żywica syntetyczna

YATO 	Grit / Ziarnistość	[mm]	
YT-83381	P40	80x40x6	10/60
YT-83382	P60	80x40x6	10/60
YT-83383	P80	80x40x6	10/60
YT-83384	P100	80x40x6	10/60
YT-83385	P120	80x40x6	10/60
YT-83386	P150	80x40x6	10/60

EN Flap wheel with shaft
 PL Ściernica listkowa trzpieniowa
 DE Fächerschleifer mit Schaft
 RU Круг лепестковый со шпинделем
 CZ Lamelový kotouč s hřídelem
 HU Legyező csiszoló csapos
 RO Perie abraziva circulara cu tija
 FR Disque à lamelles abrasives pivot
 IT Ruote lamellari
 ES Rueda laminar en tela abrasiva
 CN 百叶轮



- Application: metal
- Abrasive: aluminium oxide
- Bond: synthetic resin
- Zastosowanie: metal
- Ścierniwo: tlenek glinu
- Spoivo: żywica syntetyczna

YATO	Grit / Ziarnistość	[mm]	
YT-83390	P60	50x30x6	10/60
YT-83391	P100	50x30x6	10/60
YT-83392	P150	50x30x6	10/60
YT-83393	P200	50x30x6	10/60

EN Flap wheel with shaft
 PL Ściernica listkowa trzpieniowa
 DE Fächerschleifer mit Schaft
 RU Круг лепестковый со шпинделем
 CZ Lamelový kotouč s hřídelem
 HU Legyező csiszoló csapos
 RO Perie abraziva circulara cu tija
 FR Disque à lamelles abrasives pivot
 IT Ruote lamellari
 ES Rueda laminar en tela abrasiva
 CN 百叶轮



- Application: metal
- Abrasive: aluminium oxide
- Bond: synthetic resin
- Zastosowanie: metal
- Ścierniwo: tlenek glinu
- Spoivo: żywica syntetyczna

YATO	Grit / Ziarnistość	[mm]	
YT-83394	P60	60x50x6	10/60
YT-83395	P100	60x50x6	10/60
YT-83396	P150	60x50x6	10/60
YT-83397	P200	60x50x6	10/60

EN Flap wheel with shaft
 PL Ściernica listkowa trzpieniowa
 DE Fächerschleifer mit Schaft
 RU Круг лепестковый со шпинделем
 CZ Lamelový kotouč s hřídelem
 HU Legyező csiszoló csapos
 RO Perie abraziva circulara cu tija
 FR Disque à lamelles abrasives pivot
 IT Ruote lamellari
 ES Rueda laminar en tela abrasiva
 CN 百叶轮



- Application: metal
- Abrasive: aluminium oxide
- Bond: synthetic resin
- Zastosowanie: metal
- Ścierniwo: tlenek glinu
- Spoivo: żywica syntetyczna

YATO	Grit / Ziarnistość	[mm]	
YT-83398	P60	80x50x6	10/60
YT-83399	P100	80x50x6	10/60
YT-83400	P150	80x50x6	10/60
YT-83401	P200	80x50x6	10/60

EN Abrasive mesh
 PL Siatka ścierna
 DE Schleifgitter
 RU Абразивная сетка
 CZ Brusná síťka
 HU Csiszolóháló
 RO Disc abraziv
 FR Disque abrasif à maille
 IT Rete abrasiva
 ES Malla abrasiva
 CN 网状砂纸



YATO	Grit / Ziarnistość	Ø [mm]	pcs / szt.	
YT-845803	P60	225	3	100
YT-845813	P80	225	3	100
YT-845823	P100	225	3	100
YT-845833	P120	225	3	100
YT-845843	P150	225	3	100
YT-845853	P180	225	3	100
YT-845863	P220	225	3	100

EN Perforated abrasive disc
 PL Krążek ścierny perforowany
 DE Schleifscheibe, perforiert
 RU Перфорированный шлифовальный диск
 CZ Brusný kotouč perforovaný
 HU Perforált csiszolópapír
 RO Disc abraziv cu orificii
 FR Disque abrasif perforé
 IT Disco abrasivo perforato
 ES Muela abrasiva perforada
 CN 多孔砂纸

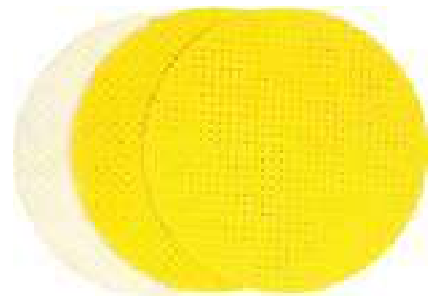

YATO	Grit / Ziarnistość	Ø [mm]	pcs / szt.	
YT-846003	P60	225	3	33
YT-846013	P80	225	3	33
YT-846023	P100	225	3	33
YT-846033	P120	225	3	33
YT-846043	P150	225	3	33
YT-846053	P180	225	3	33
YT-846063	P220	225	3	33

EN Abrasive disc
 PL Krążek ścierny
 DE Schleifblatt
 RU Круг шлифовальный
 CZ Brusný kotouč
 HU Csiszolókorong
 RO Disc abraziv
 FR Disques abrasifs avec velcro
 IT Disco abrasivo
 ES Juego de discos abrasivos
 CN 圆形砂纸



- Application: metal, wood
- Abrasive: aluminium oxide
- Bond: synthetic resin
- Coating: semi-open
- Zastosowanie: metal, drewno
- Ścierniwo: tlenek glinu
- Spoivo: żywica syntetyczna
- Nasyp: półotwarty

YATO	Grit / Ziarnistość	Ø [mm]	
YT-83430	P36	125	50/200
YT-83431	P40	125	50/200
YT-83432	P60	125	50/200
YT-83433	P80	125	50/200
YT-83434	P100	125	50/200
YT-83435	P120	125	50/200
YT-83436	P150	125	50/200
YT-83437	P180	125	50/200
YT-83438	P220	125	50/200

EN Abrasive disc with holes
 PL Krążek ścierny z otworami
 DE Schleifscheibe mit Löchern
 RU Круг шлифовальный перфорированный
 CZ Brusný kotouč s otvory
 HU Csiszolókorong nyílásokkal
 RO Disc abraziv cu orificii
 FR Disque abrasif avec trous
 IT Disco abrasivo con fori
 ES Disco abrasivo con orificios
 CN 圆形带孔砂纸



- Application: metal, wood
- Abrasive: aluminium oxide
- Bond: synthetic resin
- Coating: semi-open
- Zastosowanie: metal, drewno
- Ścierniwo: tlenek glinu
- Spoivo: żywica syntetyczna
- Nasyp: półotwarty

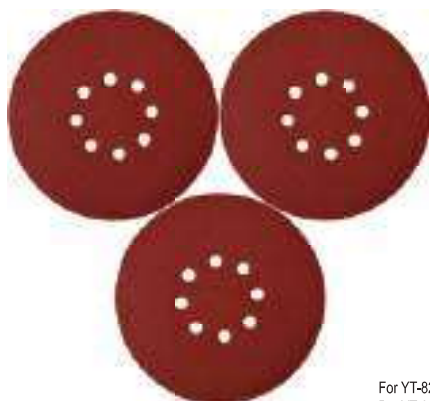

YATO	Grit / Ziarnistość	Ø [mm]	
YT-83451	P40	125	50/200
YT-83452	P60	125	50/200
YT-83453	P80	125	50/200
YT-83454	P100	125	50/200
YT-83455	P120	125	50/200
YT-83456	P150	125	50/200
YT-83457	P180	125	50/200
YT-83458	P220	125	50/200

EN Abrasive disc with holes
PL Krążek ścierny z otworami
DE Schleifscheibe mit Löchern
RU Круг шлифовальный перфорированный
CZ Brusný kotouč s otvory
HU Csiszolókorong nyílásokkal
RO Disc abraziv cu orificii
FR Disque abrasif avec trous
IT Disco abrasivo con fori
ES Disco abrasivo con orificios
CN 圆形带孔砂纸



For YT-82341
Dla YT-82341

- Application: wood, plaster, paints
- Abrasive: aluminium oxide
- Bond: synthetic resin
- Coating: open
- Zastosowanie: drewno, gips, farby
- Ścierniwo: tlenek glinu
- Spoiwo: żywica syntetyczna
- Nasyp: otwarty



YATO 	Grit / Ziarnistość	Ø [mm]	
YT-83460	P40	180	50/200
YT-83461	P60	180	50/200
YT-83462	P80	180	50/200
YT-83463	P100	180	50/200
YT-83464	P120	180	50/200
YT-83465	P150	180	50/200
YT-83466	P180	180	50/200
YT-83467	P240	180	50/200

EN Abrasive disc with holes
PL Krążek ścierny z otworami
DE Schleifscheibe mit Löchern
RU Круг шлифовальный перфорированный
CZ Brusný kotouč s otvory
HU Csiszolókorong nyílásokkal
RO Disc abraziv cu orificii
FR Disque abrasif avec trous
IT Disco abrasivo con fori
ES Disco abrasivo con orificios
CN 圆形带孔砂纸



For YT-82340, YT-82350, 79307
Dla YT-82340, YT-82350, 79307

- Application: wood, plaster
- Abrasive: aluminium oxide
- Bond: synthetic resin
- Coating: semi-open
- Zastosowanie: drewno, gips
- Ścierniwo: tlenek glinu
- Spoiwo: żywica syntetyczna
- Nasyp: półotwarty



YATO 	Grit / Ziarnistość	Ø [mm]	
YT-83471	P60	225	60/120
YT-83472	P80	225	60/120
YT-83473	P100	225	60/120
YT-83474	P120	225	60/120
YT-83475	P150	225	60/120
YT-83476	P180	225	60/120
YT-83477	P240	225	60/120

EN Abrasive disc with holes
PL Krążek ścierny z otworami
DE Schleifscheibe mit Löchern
RU Круг шлифовальный перфорированный
CZ Brusný kotouč s otvory
HU Csiszolókorong nyílásokkal
RO Disc abraziv cu orificii
FR Disque abrasif avec trous
IT Disco abrasivo con fori
ES Disco abrasivo con orificios
CN 圆形带孔砂纸



For YT-09739, YT-09740
Dla YT-09739, YT-09740

- Application: steel, wood, paints, lacquers
- Abrasive: aluminium oxide
- Bond: epoxy resin
- Coating: semi-open
- Zastosowanie: stal, drewno, farby, lakiery
- Ścierniwo: tlenek glinu
- Spoiwo: żywica epoksydowa
- Nasyp: półotwarty



YATO 	Grit / Ziarnistość	Ø [mm]	
YT-834581	P40	150	20
YT-834582	P60	150	20
YT-834583	P80	150	20
YT-834584	P100	150	20
YT-834585	P120	150	20
YT-834586	P150	150	20
YT-834587	P180	150	20
YT-834588	P220	150	20
YT-834589	P240	150	20

EN Abrasive disc with holes
PL Krążek ścierny z otworami
DE Schleifscheibe mit Löchern
RU Круг шлифовальный перфорированный
CZ Brusný kotouč s otvory
HU Csiszolókorong nyílásokkal
RO Disc abraziv cu orificii
FR Disque abrasif avec trous
IT Disco abrasivo con fori
ES Disco abrasivo con orificios
CN 圆形带孔砂纸



For YT-82206, YT-82207
Dla YT-82206, YT-82207

- Application: steel, wood, paints, lacquers
- Abrasive: aluminium oxide
- Bond: epoxy resin
- Coating: semi-open
- Zastosowanie: stal, drewno, farby, lakiery
- Ścierniwo: tlenek glinu
- Spoiwo: żywica epoksydowa
- Nasyp: półotwarty



YATO 	Grit / Ziarnistość	Ø [mm]	
YT-834591	P40	150	20
YT-834592	P60	150	20
YT-834593	P80	150	20
YT-834594	P100	150	20
YT-834595	P120	150	20
YT-834596	P150	150	20
YT-834597	P180	150	20
YT-834598	P220	150	20
YT-834599	P240	150	20

EN Abrasive sheet with holes
PL Arkusz ścierny z otworami
DE Schleifblatt mit Löchern
RU Шлифовальная перфорированная бумага для виброшлифмашинки
CZ Brusné archy z otvorami
HU Csiszoló lap lyukakkal
RO Coale (foi) abrazive cu orificii
FR Disques abrasifs trous avec velcro
IT Carta abrasiva con fori
ES Ojas abrasivas con agujeros
CN 砂纸



For YT-82230
Dla YT-82230

- Application: steel, wood, paints, filler
- Abrasive: aluminium oxide
- Bond: synthetic resin
- Coating: semi-open
- Zastosowanie: stal, drewno, farby, szpachle
- Ścierniwo: tlenek glinu
- Spoiwo: żywica syntetyczna
- Nasyp: półotwarty

YATO 	Grit / Ziarnistość	[mm]	
YT-83800	P40	93x187	100/200
YT-83801	P60	93x187	100/200
YT-83802	P80	93x187	100/200
YT-83803	P100	93x187	100/200
YT-83804	P120	93x187	100/200
YT-83805	P150	93x187	100/200
YT-83806	P180	93x187	100/200
YT-83807	P220	93x187	100/200
YT-83808	P240	93x187	100/200

- EN Back pad for drywall sander
- PL Wymienna głowica szlifierska dla szlifierki do gipsu
- DE Schleifkopf für Gips-Schleifmaschine abnehmbar
- RU Запасная шлифовальная головка для гипсовой шлифовальной машины
- CZ Náhradní brusná hlavice pro broušení sádky
- HU Cserélhető csiszolófej falcsiszoló géphez
- RO Disc pt. șlefuitor pereti
- FR Tête de ponçage de rechange pour ponçuses à plâtre
- IT Testa rotonda sostituibile per smerigliatrice per gesso
- ES Cabeza de rectificado reemplazable para la rectificadora de yeso
- CN 圓磨盤



For / Dla: YT-82340, YT-82350
 Fitting sand papers / Pasujące papiery: YT-83470, YT-83471, YT-83472, YT-83473, YT-83474, YT-83475, YT-83476, YT-83477, YT-84600, YT-84601, YT-84602, YT-84603, YT-84604, YT-84605, YT-84606

YATO	Ø [mm]	
YT-82353	225	15/60

- EN Hook and loop sanding pad
- PL Talerz polerski z rzepem
- DE Klett-Polierteller
- RU Диск с липучкой полировальный
- CZ Talíř se suchým zipem
- HU Tépőzáras tárcsa
- RO Disc de șlefuit cu scai
- FR Plateau avec velcro
- IT Platorello con velcro
- ES Plato de soporte con velcro
- CN 抛光盘



YATO	Ø [mm]	
YT-47870	75	200
YT-47872	125	150
YT-47873	150	100

- EN Hook and loop polishing sponge
- PL Gąbka polerska na rzep
- DE Klett-Polierschwamm
- RU Губка для полировки с липучкой
- CZ Leštící houba na suchý zip
- HU Tépőzáras polírozó szivacs
- RO Burete de lustruit cu scai
- FR Éponge de polissage avec velcro
- IT Tampone in spugna con velcro
- ES Esponja de pulido con velcro
- CN 海绵抛光盘

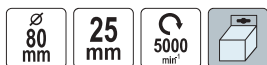

YATO	Sponge hardness / Twardość gąbki	
YT-47920	miękka	200
YT-47921	średnio twarda	200
YT-47922	twarda	200

- EN Triangle back pad for drywall sander
- PL Wymienna trójkątna głowica dla szlifierki do gipsu
- DE Dreieck-Schleifkopf für Gips-Schleifmaschine abnehmbar
- RU Запасная треугольная головка для гипсовой шлифовальной машины
- CZ Vyměnitelná trojúhelníková hlavice pro broušení sádky
- HU Háromszög alakú cserélhető csiszolófej falcsiszoló géphez
- RO Disc triunghiular pt. șlefuitor pereti
- FR Tête triangulaire de rechange pour ponçuse à plâtre
- IT Testa triangolare sostituibile per smerigliatrice per gesso
- ES Cabeza triangular reemplazable para la rectificadora de yeso
- CN 三角磨盘



For / Dla: YT-82350
 Fitting sand papers / Pasujące papiery: YT-84610, YT-84611, YT-84612, YT-84613, YT-84614, YT-84615, YT-84616

YATO	Dimensions / Wymiary [mm]	
YT-82354	280x280x280	20/60

- EN Hook and loop backing pad
- PL Uchwyt mocujący z rzepem
- DE Klett-Haftstützleier
- RU Насадка шлифовальная под круг на липучке
- CZ Unašeč se suchým zipem
- HU Rögzítőtárcsa tépőzáras
- RO Disc suport cu scai
- FR Plateau support avec velcro
- IT Platorello con velcro
- ES Plato para lijar y puli con velcro
- CN 抛光盘



YATO	Ø [mm]	max. ω [min ⁻¹]	
YT-47860	75	12000	200
YT-47890	125	5000	100

- EN Hook and loop polishing sponge
- PL Gąbka polerska na rzep
- DE Klett-Polierschwamm
- RU Губка для полировки с липучкой
- CZ Leštící houba na suchý zip
- HU Tépőzáras polírozó szivacs
- RO Burete de lustruit cu scai
- FR Éponge de polissage avec velcro
- IT Tampone in spugna con velcro
- ES Esponja de pulido con velcro
- CN 海绵抛光盘

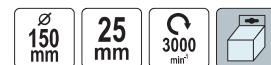

YATO	Sponge hardness / Twardość gąbki	
YT-47892	miękka	200
YT-47893	średnio twarda	150
YT-47894	twarda	200
YT-47895	bardzo twarda	200

EN Hook and loop sanding sponge
PL Gąbka ścierna na rzep
DE Klett-Schleifschwamm
RU Губка полировальная с липучкой
CZ Abrázivní houba na suchý zip
HU Tépözárás csiszológyszivacs
RO Burete de șlefuit cu scai
FR Éponge abrasive à velcro
IT Spugna abrasiva con velcro
ES Esponja abrasiva con velcro
CN 海绵抛光盘



YATO		
YT-47896		200

EN Thread adapter
PL Adapter z gwintem
DE Adapter mit Gewinde
RU Адаптер с винтом
CZ Adaptér se závitem
HU Menetes adapter
RO Adaptor cu filet
FR Adaptateur avec filetage
IT Adattatore con filettatura
ES Adaptador con rosca
CN 接杆

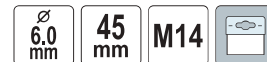

YATO	Ø [mm]	
YT-47868	6	500

EN Polishing pad
PL Pad polerski
DE Polierpad
RU Диск полировальный
CZ Leštící kotouč
HU Polírozó tárcsa
RO Disc de lustruit
FR Tampon de polissage
IT Disco lucidatura
ES Pad de pulido
CN 海绵抛光盘



YATO	Sponge hardness / Twardość gąbki	
YT-47880	miękka	60
YT-47881	średnio twarda	60
YT-47882	twarda	60
YT-47883	bardzo twarda	60

EN Polishing pad with sanding sponge
PL Pad polerski z gąbką ścierną
DE Polierpad mit Schleifschwamm
RU Диск полировальный с губкой
CZ Leštící kotouč abrazivní houba
HU Polírozó tárcsa csiszológyszivaccsal
RO Disc de lustruit cu burete de șlefuit
FR Tampon de polissage avec éponge abrasive
IT Tampone lucidante con spugna abrasiva
ES Pad de pulido con esponja abrasiva
CN 海绵抛光盘



YATO		
YT-47884		60

EN Polishing felt
PL Filc polerski
DE Polierfilz
RU Диск с войлоком для полировки
CZ Leštící filc
HU Poplírozó filc
RO Pâslă de lustruire
FR Feutre de polissage
IT Disco in feltro per lucidatura
ES Fieltro de pulido
CN 羊毛抛光盘



YATO	Ø [mm]	H [mm]	
YT-47902	75	10	200
YT-47901	125	10	150
YT-47900	125	20	100

EN Hook and loop buffing pad
PL Futro polerskie na rzep
DE Klett-Polierfell
RU Полировальный меховой круг на липучке
CZ Vlněný leštící kotouč na suchý zip
HU Tépözárás gyapjas polírozó korong
RO Tampă de lustruire cu scai
FR Tampon de polissage à velcro
IT Pelliccia lucidante con velcro
ES Piel de pulido con velcro
CN 羊毛抛光盘



YATO	Ø [mm]	
YT-47910	80	200
YT-47911	125	100
YT-47912	150	80
YT-47913	180	60

EN Polishing pad kit
 PL Zestaw do polerowania
 DE Polierpad-Set
 RU Набор для полировки
 CZ Leštící sada
 HU Polírozó készlet
 RO Kit discuri de lustruit
 FR Kit de polissage
 IT Kit per lucidatura
 ES Conjunto para pulido
 CN 抛光海绵

12 PCS **80** mm **6000** min⁻¹ **M10**



YATO	Ø [mm]	
YT-47930	80	80

EN Polishing pad kit
 PL Zestaw do polerowania
 DE Polierpad-Set
 RU Набор для полировки
 CZ Leštící sada
 HU Polírozó készlet
 RO Kit discuri de lustruit
 FR Kit de polissage
 IT Kit per lucidatura
 ES Conjunto para pulido
 CN 抛光海绵

12 PCS **6000** min⁻¹ **M14**



YATO	Ø [mm]	
YT-47931	125	30
YT-47932	150	30

EN Polishing pad kit
 PL Zestaw do polerowania
 DE Polierpad-Set
 RU Набор для полировки
 CZ Leštící sada
 HU Polírozó készlet
 RO Kit discuri de lustruit
 FR Kit de polissage
 IT Kit per lucidatura
 ES Conjunto para pulido
 CN 抛光海绵

8 PCS **180** mm **6000** min⁻¹ **M14**



YATO	Ø [mm]	
YT-47933	180	30

EN Polishing pads
 PL Nakładki polerskie
 DE Polierhauben
 RU Накладки для полировки
 CZ Leštící kotouče
 HU Polírozó sapkák
 RO Discuri de lustruit
 FR Tampons de polissage
 IT Cuffie per lucidatura
 ES Almohadillas para pulido
 CN 仿毛抛光盘

2 PCS **250** mm **5000** min⁻¹



For YT-82922
 Dla YT-82922

YATO	Ø [mm]	
YT-47940	250	60

EN Polishing sponges for rims
 PL Gąbki polerskie do felg
 DE Polierschwämme für Felgen
 RU Полировальные губки для автомобильных шин
 CZ Leštící houby na ráčky
 HU Felnicésizsoló szivacsok
 RO Bureți de lustruit pt. jante
 FR Éponges de polissage des jantes
 IT Spugne lucidanti per cerchi
 ES Esponjas de pulido para llantas
 CN 海绵抛光轮

3 PCS **30-75** mm **80** mm **6000** min⁻¹ **6** mm



YATO	Ø [mm]	
YT-47945	30-75	100