

**Screwdrivers, 3 color handle**  
Wkrętki, trójkolorowa rączka

78-80



Slotted screwdrivers Wkrętki płaskie.....	78
Phillips screwdrivers Wkrętki krzyżakowe.....	78
Pozidrive screwdrivers Wkrętki „Pozidrive”.....	78
Torx screwdrivers Wkrętki „Torx”.....	78
Torx Security screwdrivers Wkrętki „Torx Security”.....	78
Go-through screwdrivers Wkrętki do pobijania.....	78
Screwdriver sets Komplety wkrętek.....	79

**Screwdrivers, 3 color handle**  
Wkrętki, trójkolorowa rączka

80



Screwdriver sets Komplety wkrętek.....	80
---	----

**Precision screwdrivers, 3 color handle**  
Wkrętki precyzyjne, trójkolorowa rączka

81



Precision slotted screwdrivers Wkrętki precyzyjne płaskie.....	81
Precision phillips screwdrivers Wkrętki precyzyjne krzyżakowe.....	81
Precision Torx screwdrivers Wkrętki precyzyjne „Torx”.....	81
Precision screwdriver sets Zestawy wkrętek precyzyjnych.....	81

**Special screwdrivers & impact screwdrivers**  
Wkrętki specjalne i udarowe

82-83



Ratchet screwdriver sets Wkrętki z grzechotką.....	82
Impact screwdrivers Wkrętki udarowe.....	83

**Screwdriver bits**  
Kończówki wkrętkowe

84-91



Phillips screwdriver bits Kończówki wkrętkowe krzyżakowe.....	84
Torx screwdriver bits Kończówki wkrętkowe „Torx”.....	84
YATO NON-SLIP SYSTEM screwdriver bits Kończówki wkrętkowe „YATO NON-SLIP SYSTEM”.....	84
Screwdriver bit sets Zestawy końcówek wkrętkowych.....	87

**Nut setters**

Nasadki magnetyczne do wkrętarek

91



**Screwdriver bit holders**

Uchwyty do końcówek wkrętkowych

91-94



**Hex & Torx keys & sets**

Klucze imbusowe i zestawy

95-101



T-handle keys & sets Klucze imbusowe typu „T” i zestawy.....	95
Hex keys & sets Klucze imbusowe i zestawy.....	96
Torx & Torx Security keys & sets Klucze „Torx”, „Torx Security” i zestawy.....	97
Plastic covered hex & Torx Security keys Klucze imbusowe powlekane.....	101

EN Screwdriver CZ Šroubovák IT Cacciavite  
 PL Wkrętarz HU Csavarhúzó ES Destornillador  
 DE Schraubendreher RO Șurubelniță CN 一字螺丝批  
 RU Отвёртка FR Tournevis



YATO	⊖ [mm]	L [mm]	PCS PKG	
YT-25900	2	75	12	96/384
YT-25901	3	75	12	96/384
YT-25902	3	100	12	96/384
YT-25903	3	150	12	60/240
YT-25904	4	100	12	96/384
YT-25905	4	150	12	96/384
YT-25906	4	200	12	96/384
YT-25907	5	75	12	60/240
YT-25908	5	100	12	60/240
YT-25909	5	150	12	60/240
YT-25910	6	38	12	60/240
YT-25911	6	100	12	36/144
YT-25912	6	150	12	36/144
YT-25913	6	200	12	36/144
YT-25914	8	150	6	24/96



YATO	⊕	L [mm]	PCS PKG	
YT-25920	PH0	75	12	96/384
YT-25921	PH0	100	12	96/384
YT-25922	PH1	38	12	60/240
YT-25923	PH1	75	12	60/240
YT-25924	PH1	100	12	60/240
YT-25925	PH1	150	12	60/240
YT-25926	PH1	200	12	36/144
YT-25927	PH1	300	6	24/96
YT-25928	PH2	38	12	60/240
YT-25929	PH2	100	12	36/144
YT-25930	PH2	150	12	36/144
YT-25931	PH2	200	12	36/144
YT-25932	PH2	300	6	24/96
YT-25933	PH3	150	6	24/96
YT-25934	PH3	200	6	24/96



YATO	⊕	L [mm]	PCS PKG	
YT-25940	PZ1	75	12	60/240
YT-25941	PZ1	100	12	60/240
YT-25942	PZ2	100	12	36/144
YT-25943	PZ2	150	12	36/144



YATO	⊗	L [mm]	PCS PKG	
YT-25950	T5	75	12	96/384
YT-25951	T6	75	12	96/384



YATO	⊗	L [mm]	PCS PKG	
YT-25952	T7	75	12	96/384
YT-25953	T8	75	12	96/384
YT-25954	T9	75	12	96/384
YT-25955	T10	100	12	60/240
YT-25956	T15	100	12	60/240
YT-25957	T20	100	12	60/240
YT-25958	T25	100	12	36/144
YT-25959	T27	100	12	36/144
YT-25960	T30	100	12	36/144
YT-25961	T40	100	6	24/96

EN Go-through screwdriver RU Отвёртка-било RO Șurubelniță pt. fixare ES Destornillador para dar golpes  
 PL Wkrętarz do pobijania CZ Šroubovák s úderným koncem FR Tournevis à frapper CN 一字敲击螺丝批  
 DE Schlagschrauber HU Beütő csavarhúzó IT Cacciaviti per viti con intaglio



YATO	⊖ [mm]	L [mm]	PCS PKG	
YT-25985	6	100	6	24/96
YT-25986	6	150	6	24/96
YT-25987	6	200	6	24/96
YT-25988	6	250	6	24/96
YT-25989	8	150	6	24/72
YT-25990	8	200	6	24/72
YT-25991	8	250	6	24/72
YT-25992	8	300	6	24/72



YATO	⊕	L [mm]	PCS PKG	
YT-25993	PH2	100	6	24/96
YT-25994	PH2	150	6	24/96
YT-25995	PH3	150	6	24/72
YT-25996	PH3	200	6	24/72
YT-25997	PH3	250	6	24/72

EN Screwdriver set  
PL Komplet wkrętarci  
DE Schraubendrehersatz  
RU Набор отвёрток  
CZ Zámečnické šroubováky  
HU Lakatos csavarhózó  
RO Şurubelnițe de lăcătuşerie  
FR Set de tournevis  
IT Set cacciaviti  
ES Juego de destornilladores  
CN 敲击螺丝批组套

2  
PCS

⊖ ⊕

HRC 52 CrV 6150



⊖ 6.0 mm (L=150 mm);  
⊕ PH2 (L=150 mm)

**YATO**  
YT-25998 6/36

EN Screwdriver set  
PL Komplet wkrętarci  
DE Schraubendrehersatz  
RU Набор отвёрток  
CZ Zámečnické šroubováky  
HU Lakatos csavarhózó  
RO Şurubelnițe de lăcătuşerie  
FR Set de tournevis  
IT Set cacciaviti  
ES Juego de destornilladores  
CN 螺丝批组套

⊖ ⊕

HRC 58 S2



6  
PCS

⊖ ⊕

⊖ 3.0 mm (L=75 mm), 5.0, 6.0 mm (L=100 mm);  
⊕ PH0 (L=75 mm), PH1, PH2 (L=100 mm)

8  
PCS

⊖ ⊕

⊖ 2.0, 2.4 mm (L=50 mm), 6.0 mm (L=38 mm), 6.0 mm (L=100 mm);  
⊕ PH0, PH1 (L=50 mm), PH2 (L=38 mm), PH2 (L=100 mm)

**YATO**  
YT-25965 6/24

**YATO**  
YT-25980 6/24



8  
PCS

⊖ ⊕

⊖ 5.0, 6.0 mm (L=100 mm), 8.0 mm (L=150 mm);  
⊕ PH0 (L=75 mm), PH1, PH2 (L=100 mm), PH2 (L=38 mm), PH3 (L=150 mm)

12  
PCS

⊖ ⊕

⊖ 3.0, 5.0 mm (L=75 mm), 6.0 mm (L=38 mm), 6.0, 8.0 mm (L=150 mm);  
⊕ PH0, PH1 (L=75 mm), PH2 (L=38 mm), PH2 (L=100 mm), PH3 (L=150 mm);  
⊖ SQ1, SQ2 (L=100 mm)

**YATO**  
YT-25966 6/12

**YATO**  
YT-25967 6/12

EN Screwdriver set  
PL Komplet wkrętarci  
DE Schraubendrehersatz  
RU Набор отвёрток  
CZ Zámečnické šroubováky  
HU Lakatos csavarhózó  
RO Şurubelnițe de lăcătuşerie  
FR Set de tournevis  
IT Set cacciaviti  
ES Juego de destornilladores  
CN 螺丝批组套



15  
PCS

⊖ ⊕

⊖ ⊕

⊖ ⊕

HRC 58

S2

⊖ ⊕

⊖ 1.5, 2.0 mm (L=50 mm), 5.0 mm (L=75 mm), 6.0 mm (L=38 mm), 6.0 mm (L=100 mm), 6.0 mm (L=125 mm);  
⊕ PH00, PH0 (L=50 mm), PH1 (L=75 mm), PH2 (L=38 mm), PH2 (L=100 mm);  
⊖ T5, T6, T7, T8 (L=50 mm)

**YATO**  
YT-25981 6/24

EN Screwdriver set  
PL Komplet wkrętarci  
DE Schraubendrehersatz  
RU Набор отвёрток  
CZ Zámečnické šroubováky  
HU Lakatos csavarhózó  
RO Şurubelnițe de lăcătuşerie  
FR Set de tournevis  
IT Set cacciaviti  
ES Juego de destornilladores  
CN 螺丝批组套



9  
PCS

⊖ ⊕

⊖ ⊕

⊖ ⊕

HRC 58

S2

⊖ ⊕

⊖ 3.0, 5.0 mm (L=75 mm), 6.0 mm (L=100 mm), 6.0, 8.0 mm (L=150 mm);  
⊕ PH0, PH1 (L=75 mm), PH2 (L=100 mm), PH2 (L=150 mm)

**YATO**  
YT-25968 6/12

EN 6 in 1 interchangeable screwdriver set  
 PL Wkrętarz z końcówkami dwustronnymi  
 DE Umsteckschraubendreher  
 RU Отвёртка с двухсторонними насадками  
 CZ Šroubovák lancer s dvoustrannou koncovkou  
 HU Csavarhúzó kétvégű szárral

RO Şurubelniţă cu dublu capăt  
 FR Tournevis embouts réversibles  
 IT Cacciavite reversibile  
 ES Destornillador con punta de dos caras  
 CN 螺丝批

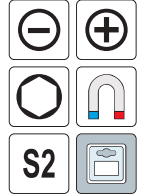

⌀ 5.0 mm x PH1, 6.0 mm x PH2;  
 ⌀ 1/4" (6.3 mm) x 5/16" (8 mm)

EN Screwdriver set  
 PL Komplet wkrętarzów  
 DE Schraubendrehersatz  
 RU Набор отвёрток  
 CZ Zámečnické šroubováky  
 HU Lakatos csavarhózó  
 RO Şurubelniţe de lăcătuşerie  
 FR Set de tournevis  
 IT Set cacciaviti  
 ES Juego de destornilladores  
 CN 螺丝批组套



⌀ 2.4, 3.0 mm (L=50 mm), 5.0 mm (L=75 mm), 6.0 mm (L=38 mm), 6.0 mm (L=100 mm), 8.0 mm (L=150 mm);  
 ⌀ PH00, PH0 (L=50 mm), PH1 (L=75 mm), PH2 (L=38 mm), PH2 (L=100 mm), PH3 (L=150 mm);  
 ⌀ T5, T6, T7, T8, T9, T10 (L=50 mm)

**YATO** 6/12  
 YT-25982

EN Screwdriver set  
 PL Komplet wkrętarzów  
 DE Schraubendrehersatz  
 RU Набор отвёрток  
 CZ Zámečnické šroubováky  
 HU Lakatos csavarhózó

RO Şurubelniţe de lăcătuşerie  
 FR Set de tournevis  
 IT Set cacciaviti  
 ES Juego de destornilladores  
 CN 螺丝批组套

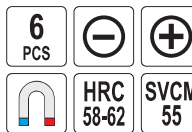

⌀ 5.5, 6.5 mm (L=100 mm), 8.0 mm (L=150 mm);  
 ⌀ PH1, PH2 (L=100 mm), PH3 (L=150 mm)

**YATO** 6/24  
 YT-2668

**YATO** 12/96  
 YT-25971

EN Mini pick & hook set  
 PL Zestaw haczyków z rękojeścią  
 DE Mini Hacken Set  
 RU Набор ключков с рукоятками  
 CZ Sada háčkových mini páčidel  
 HU Mini ár és kampó készlet  
 RO Mini-set pt. extras gamturi  
 FR Set de crochets  
 IT Set ganci con maniglia  
 ES Juego de palancas de hierro  
 CN 迷你拉拔器组套



**YATO** 12/72  
 YT-0843

EN Screwdriver set  
 PL Komplet wkrętarzów  
 DE Schraubendrehersatz  
 RU Набор отвёрток  
 CZ Zámečnické šroubováky  
 HU Lakatos csavarhózó

RO Şurubelniţe de lăcătuşerie  
 FR Set de tournevis  
 IT Set cacciaviti  
 ES Juego de destornilladores  
 CN 螺丝批组套

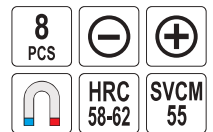

⌀ 4.0, 5.5, 6.5 mm (L=100 mm), 6.5 mm (L=38 mm);  
 ⌀ PH0 (L=75 mm), PH1, PH2 (L=100 mm), PH2 (L=38 mm)

**YATO** 4/16  
 YT-2670

EN Precision screwdriver  
PL Wkrętak precyzyjny  
DE Präzisions-Schraubendreher  
RU Отвёртка для точных работ

CZ Šroubovák pro jemnou mechaniku  
HU Műszerész csavarhúzó  
RO Șurubelniță mecanica fina  
FR Tournevis de précision

IT Cacciavite di precisione  
ES Destornillador de precisión  
CN 一字钟表螺丝批

HRC 57-61

S2



YATO	⊖ [mm]	L [mm]	☐
YT-25802	1.4	50	50/400
YT-25803	1.6	50	50/400
YT-25804	1.8	50	50/400
YT-25805	2.0	50	50/400
YT-25806	2.0	75	50/400
YT-25807	2.4	50	50/400
YT-25808	2.4	75	50/400
YT-25809	3.0	50	50/400
YT-25810	3.0	75	50/400
YT-25811	3.0	100	50/400



YATO	⊕	L [mm]	☐
YT-25831	PH000	50	50/400
YT-25832	PH000	75	50/400
YT-25833	PH00	50	50/400
YT-25834	PH00	75	50/400
YT-25835	PH0	50	50/400
YT-25836	PH0	75	50/400
YT-25837	PH0	100	50/400
YT-25838	PH1	50	50/400
YT-25839	PH1	100	50/400
YT-25840	PH1	150	50/400



YATO	⊛	L [mm]	☐
YT-25852	T5	50	50/400
YT-25853	T6	50	50/400
YT-25854	T7	50	50/400
YT-25855	T8	50	50/400
YT-25856	T9	50	50/400
YT-25857	T10	50	50/400

EN Precision screwdriver set  
PL Zestaw wkrętaków precyzyjnych  
DE Präzisions-Feinmechanikersatz  
RU Набор прецизионных отвёрток

CZ Šroubováky sada pro jemnou mechaniku  
HU Órás csavarhúzó készlet  
RO Set surubelnite  
FR Set de tournevis de précision

IT Set cacciavite di precisione  
ES Destornilladores precisos  
CN 钟表螺丝批组套

HRC 57-61

S2



6 PCS



⊖ 1.4, 2.0, 2.4 mm (L=50 mm);  
⊕ PH00, PH0, PH1 (L=50 mm)

6 PCS



⊛ T5, T6, T7, T8, T9, T10 (L=50 mm)



7 PCS



⊖ 2.0, 3.0 mm (L=50 mm);  
⊕ PH00, PH0 (L=50 mm);  
⊛ T5, T6, T7 (L=50 mm)



**YATO**  
YT-25861

☐  
6/36

**YATO**  
YT-25862

☐  
6/36

**YATO**  
YT-25863

☐  
6/36

EN Mobile phone repair tools set  
PL Zestaw do naprawy telefonów komórkowych  
DE Mobiltelefon Reparatur Satz  
RU Набор инструмента для ремонта мобильных телефонов  
CZ Nástroje na opravu mobilních telefonů  
HU Mobiltelefon-javítás szerszámkészlet

RO Set surubelnite service telefoane mobile  
FR Outils de réparation de téléphone mobil  
IT Set di riparazione del telefono cellulare  
ES Herramientas de la reparación del teléfono móvil fijadas  
CN 精密批维修套装



- ⊖ (L=100 mm);
- ⊖ (L=145 mm);
- ⊖ 1/4" (6.3 mm); (L=46 mm); S2;
- ⊖ (L=60 mm);
- ⊖ (L=85 mm);
- ⊖ 2.5, 3.0, 3.5, 4.0, 4.5, 5.0, 5.5 mm; PH2 (magnetic); S2;
- ⊖ 1.0, 1.5, 2.0, 2.5, 3.0, 3.5, 4.0 mm (L=25 mm); S2;
- ⊖ PH000, PH00, PH0, PH1, PH2 (L=25 mm); S2;
- ⊖ T2, T3, T4, T5, T6, T7 (L=25 mm); S2;
- ⊖ T8, T9, T10, T15, T20 (L=25 mm); S2;
- ⊖ 0.7, 0.9, 1.3, 1.5, 2.0, 2.5, 3.0, 4.0, 4.5, 5.0, 6.0 mm (L=25 mm); S2;
- ⊖ S0, S1, S2 (L=25 mm); S2;
- ⊖ 0.8, 1.2, 1.5 mm (L=25 mm); S2;
- ⊖ 0.6, 2.0, 2.5 mm (L=25 mm); S2;
- ⊖ 2.0, 3.0 mm (L=25 mm); S2;
- ⊖ 2.6, 3.0 mm (L=25 mm); S2;
- ⊖ 0.8 mm (L=25 mm); S2

61 PCS

5/32" 4.0 mm



S2



**YATO**  
YT-25760

☐  
25/50

EN 22 in 1 interchangeable screwdriver set  
 PL Wkrętarz z końcówkami dwustronnymi  
 DE Umsteckschraubendreher  
 RU Отвёртка - двухсторонние насадки  
 CZ Šroubovák lanecr z dvoustrannou koncovkou  
 HU Csavarhúzó kétvégű szárral

RO Şurubelnită cu dublu capăt  
 FR Tournevis + embouts 22 en 1  
 IT Set cacciavite con punte reversibile  
 ES Destornillador con punta dos caras  
 CN 螺丝批组套

12  
PCS

22in1  
22w1



SVCN



- 4 mm x 5.5 mm (L=175/115 mm)
- ⊕ 6.5 mm x PH3 (L=175/115 mm)
- ⊕ PH1 x PH2 (L=175/115 mm)
- ⊕ PZ1 x PZ2 (L=175/115 mm)
- 3 mm x 3 mm (L=175/115 mm)
- 4 mm x 4 mm (L=175/115 mm)
- 5 mm x 5 mm (L=175/115 mm)
- 6 mm x 6 mm (L=175/115 mm)
- ⊗ T10 x T15 (L=175/115 mm)
- ⊗ T20 x T25 (L=175/115 mm)
- ⊗ T30 x T40 (L=175/115 mm)

**YATO** **YT-2797** 6/12

EN Ratchet screwdriver with bits  
 PL Wkrętarz z grzechotką i bitami  
 DE Schraubendreher mit Ratche  
 RU Отвёртка с рatchetкой  
 CZ Šroubovák z řetáčkou  
 HU Racsnis csavarbehajtó  
 RO Antrenor cu clichet + set biti  
 FR Coffret tournevis a cliquet réversible porte-embouts  
 IT Set di inserti con chiave a cricchetto  
 ES Juego con destornillador y carraca  
 CN 螺丝批组套

11  
PCS

1/4"  
6.3 mm



72T

CrV  
6150

S2



- 1/4" (6.3 mm): 4, 5, 6 mm; S2;
- ⊕ 1/4" (6.3 mm): PH0, PH1, PH2; S2;
- 1/4" (6.3 mm): S1, S2, S3; S2;
- ⊗

**YATO** **YT-14390** 1/4" (6.3 mm) 25/50

EN Screwdriver set with bits  
 PL Zestaw - wkrętarz z końcówkami  
 DE Schraubendreher- und Bit-Set  
 RU Набор - отвёртка с битами  
 CZ Sada - šroubovák s koncovkami  
 HU Készlet - csavarhúzó bitfejekkel

RO Set surubelnita cu biti  
 FR Ensemble tournevis avec embout  
 IT Set - avvitatrice con punte  
 ES Juego de atornillador con puntas  
 CN 螺丝批组套



28  
PCS



S2

CrV



- 6, 7, 8, 10, 12 mm; CrV;
- ⊕ 1.5 mm x PH000, 2.0 mm x PH00, 2.5 mm x PH0, 3.0 mm x PH1 (L=75 mm); 1.5 mm x PH000, 2.0 mm x PH00, 2.5 mm x PH0 (L=115 mm); S2;
- ⊗ T6 x T7, T8 x T9 (L=75 mm); T6 x T7, T8 x T9 (L=115 mm); S2;
- 2 x 3 mm (L=75 mm); S2;
- 5 x 6 mm (L=75 mm); 5 x 6 mm (L=115 mm); S2;
- ⊕ PH1 x PH2, PH2 x PH3 (L=75 mm); PH1 x PH2, PH2 x PH3 (L=115 mm); S2;
- S1 x S2 (L=75 mm); S1 x S3 (L=115 mm); S2;
- 5 x 6 mm (L=75 mm); S2;
- ⊗ T10 x T15 (L=115 mm); S2

**YATO** **YT-27940** 6/12

EN Precision screwdriver with bits  
 PL Wkrętarz elastyczny z wymiennymi bitami  
 DE Schraubendreher- und Bit-Satz  
 RU Отвёртка с прецизионными битами  
 CZ Šroubovák ráčnový se sadou bitů  
 HU Órás csavarhúzó-bit készlet

RO Surubelnita + set biti  
 FR Tournevis élastique  
 IT Cacciavite flessibile con punte intercambiabili  
 ES Juego de piezas terminales para destornillador + mango  
 CN 可弯曲批头组套

31  
PCS

215  
mm

1/4"  
6.3mm



CrV  
6150

S2

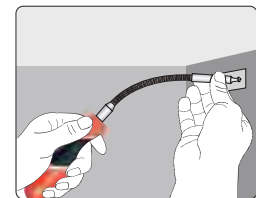

- 1/4" (6.3 mm): 3.0, 3.5, 4.0, 5.5, 6.5 mm (L=25 mm);
- ⊕ 1/4" (6.3 mm): PH0, PH1, PH2, PH3 (L=25 mm);
- ⊕ 1/4" (6.3 mm): PZ0, PZ1, PZ2, PZ3 (L=25 mm);
- ⊗ 1/4" (6.3 mm): T10, T15 (L=25 mm);
- 1/4" (6.3 mm): 2, 3, 4, 5, 6 mm (L=25 mm);
- 1/4" (6.3 mm): 5, 6, 7, 8 x2, 9, 10, 11, 12, 13 mm

**YATO** **YT-25972** 6/24

EN Ratchet screwdriver set  
PL Wkrętak z grzechotką, przegubem i bitami  
DE Ratschenschraubendreher-Satz mit Einsätzen  
RU Набор головок с трещеткой  
CZ Ráčnový kloubový šroubovák s příslušenstvím  
HU Dugókulcs és bit készlet csukló

RO Set surubelnita  
FR Clé mixte à cliquet + embouts  
IT Set do chiavi a cricchetto e inserti  
ES Juego con destornillador y carraca  
CN 棘轮螺丝批组套



42 PCS  
1/4" 6,3mm  
- +  
+ -  
AISI S2  
CrV 50BV30

1/4" (6.3 mm): 5, 6, 7, 8, 9, 10, 11, 12, 13 mm;  
1/4" (6.3 mm) (L=100 mm);  
1/4" (6.3 mm); CrV 50BV30;  
3, 4, 5, 6, 7 mm;  
PH1 x2, PH2 x2, PH3 x2;  
PZ1 x2, PZ2 x2, PZ3 x2;  
T10, T15, T20, T25, T27, T30, T40;  
2, 2.5, 3, 4, 5, 6 mm

**YATO**  
YT-2806 12

EN Impact screwdriver  
PL Wkrętak udarowy  
DE Schlagschrauber  
RU Отвёртка ударная  
CZ Narazový šroubovák kovový  
HU Kézi ütvecsavarhúzó

RO Şurubelniţă metalică cu percutor  
FR Tournevis à choc  
IT Cacciavite percussione  
ES Destornillador de percusión  
CN 冲击螺丝批组套



7 PCS  
1/2" 12,7 mm  
5/16" 8 mm  
- +  
+ -  
CrV 6150

5/16" (7.9 mm) x 1/2" (12.7 mm);  
7, 8 mm (L=35 mm); 8 mm (L=75 mm);  
PH2, PH3 (L=35 mm); PH2 (L=75 mm)

**YATO**  
YT-2801 5/20

EN Impact screwdriver  
PL Wkrętak udarowy  
DE Schlagschrauber  
RU Отвёртка ударная  
CZ Narazový šroubovák kovový  
HU Kézi ütvecsavarhúzó

7 PCS  
175 mm  
1/2" 12,7 mm  
5/16" 8 mm  
- +  
+ -  
CrV 6150

RO Şurubelniţă metalică cu percutor  
FR Tournevis à choc  
IT Cacciavite percussione  
ES Destornillador de percusión  
CN 冲击螺丝批



5/16" (7.9 mm) x 1/2" (12.7 mm);  
7, 8 mm (L=35 mm); 8 mm (L=75 mm);  
PH2, PH3 (L=35 mm); PH3 (L=75 mm)

**YATO**  
YT-2803 8/16

EN Impact screwdriver  
PL Wkrętak udarowy  
DE Schlagschrauber  
RU Отвёртка ударная  
CZ Narazový šroubovák kovový  
HU Kézi ütvecsavarhúzó

RO Şurubelniţă metalică cu percutor  
FR Tournevis à choc  
IT Cacciavite percussione  
ES Destornillador de percusión  
CN 冲击螺丝批组套

15 PCS  
160 mm  
1/2" 12,7 mm  
5/16" 8 mm  
- +  
+ -  
CrV 6150  
S2



5/16" (7.9 mm) x 1/2" (12.7 mm);  
4, 5, 6, 8, 9 mm (L=35 mm); S2;  
PH1, PH2, PH3, PH4 (L=35 mm); S2;  
4, 5, 6, 8 (L=35 mm); S2

**YATO**  
YT-28015 16

EN Impact screwdriver  
PL Wkrętak udarowy  
DE Schlagschrauber  
RU Отвёртка ударная  
CZ Narazový šroubovák kovový  
HU Kézi ütvecsavarhúzó

7 PCS  
1/2" 12,7 mm  
5/16" 8 mm  
- +  
+ -  
CrV 6150

RO Şurubelniţă metalică cu percutor  
FR Tournevis à choc  
IT Cacciavite percussione  
ES Destornillador de percusión  
CN 冲击螺丝批



5/16" (7.9 mm) x 1/2" (12.7 mm);  
8 mm (L=35 mm); 8 mm (L=75 mm);  
PH3 (L=35 mm); PH1, PH2, PH3 (L=75 mm)

**YATO**  
YT-2802 20

EN Impact screwdriver  
PL Wkrętak udarowy  
DE Schlagschrauber  
RU Отвёртка ударная  
CZ Narazový šroubovák kovový  
HU Kézi ütvecsavarhúzó

32 PCS  
168 mm  
1/2" 12,7 mm  
- +  
+ -  
CrV 6150  
S2

RO Şurubelniţă metalică cu percutor  
FR Tournevis à choc  
IT Cacciavite percussione  
ES Destornillador de percusión  
CN 冲击螺丝批组套



1/2" (12.7 mm): 10, 13, 15 mm; CrV 6150;  
0.8x5.5, 1.2x6.5, 1.2x8, 1.6x10, 2x12, 2.5x14 mm (L=35 mm); S2;  
PH1, PH2, PH3, PH4 (L=35 mm); PH2, PH3 (L=75 mm); S2;  
T25, T27, T30, T40, T45, T50, T55 (L=35 mm); S2;  
4, 5, 6, 7, 8, 10, 12 mm (L=35 mm); S2;  
#3, #4

**YATO**  
YT-28000 10

EN Screwdriver bit set  
 PL Zestaw bitów do wkrętek udarowych  
 DE Schraubendreherbitsatz  
 RU Набор бит крестовых  
 CZ Sada bitů  
 HU Bitkészlet  
 RO Truse bit  
 FR Embouts à choc  
 IT Set punte cacciavite  
 ES Puntas de destornilladora  
 CN 冲击批头组套



EN Screwdriver bit  
 PL Końcówka śrubokrętowa  
 DE Schraubendreherbit  
 RU Вставка-бита  
 CZ Šroubovací bit  
 HU Csavarbit  
 RO Capăt pt. șurubelniță  
 FR Embout de tournevis  
 IT Punta per cacciavite  
 ES Punta de destornillador  
 CN 旋具头



YATO	Tip	L [mm]	Hex [mm]	Box
YT-0404	T25	30	10	10/100
YT-0405	T25	75	10	10/100
YT-04051	T30	30	10	10/100
YT-04052	T30	75	10	10/100
YT-0406	T40	30	10	10/100
YT-0407	T40	75	10	10/100
YT-0408	T45	30	10	10/100
YT-0409	T45	75	10	10/100

YATO	+	-	L [mm]	Hex	pcs / szt.	Box
YT-2810	PH2	-	36	5/16" (7.9 mm)	5	10/100
YT-2811	PH3	-	36	5/16" (7.9 mm)	5	10/100
YT-2812	PH2, PH3	8, 10	36	5/16" (7.9 mm)	4	10/100

EN Screwdriver bit  
 PL Końcówka śrubokrętowa  
 DE Schraubendreherbit  
 RU Вставка-бита  
 CZ Šroubovací bit  
 HU Csavarbit  
 RO Capăt pt. șurubelniță  
 FR Embout de tournevis  
 IT Punta per cacciavite  
 ES Punta de destornillador  
 CN 旋具头



YATO	+	L [mm]	Hex	Box
YT-0485	PH2	100	1/4" (6.3 mm)	25/100
YT-0486	PH2	150	1/4" (6.3 mm)	25/100
YT-0487	PH2	200	1/4" (6.3 mm)	25/100

EN Screwdriver bit  
 PL Końcówka śrubokrętowa  
 DE Schraubendreherbit  
 RU Бит крестовая  
 CZ Šroubováková koncovka  
 HU Csavarhúzóvég  
 RO Capăt pt. șurubelniță  
 FR Douille tournevis  
 IT Punta del cacciavite  
 ES Punta de destornilladora  
 CN 旋具头组套



YATO	+	L [mm]	Hex	[Nm]	pcs / szt.	Box
YT-04702	PZ1	25	1/4" (6.3 mm)	6.4	10	25/200
YT-04712	PZ2	25	1/4" (6.3 mm)	19.6	10	25/200
YT-04722	PZ3	25	1/4" (6.3 mm)	45.1	10	25/200

YATO	+	L [mm]	Hex	[Nm]	pcs / szt.	Box
YT-04742	PH1	25	1/4" (6.3 mm)	6.4	10	25/200
YT-04752	PH2	25	1/4" (6.3 mm)	19.6	10	25/200
YT-04762	PH3	25	1/4" (6.3 mm)	45.1	10	25/200

EN Screwdriver bit  
 PL Końcówka śrubokrętowa  
 DE Schraubendreherbit  
 RU Бит крестовая  
 CZ Šroubováková koncovka  
 HU Csavarhúzóvég  
 RO Capăt pt. șurubelniță  
 FR Douille tournevis  
 IT Punta del cacciavite  
 ES Punta de destornilladora  
 CN 旋具头组套



YATO	+	L [mm]	Hex	[Nm]	pcs / szt.	Box
YT-04772	PH1	50	1/4" (6.3 mm)	6.4	10	25/100
YT-04782	PH2	50	1/4" (6.3 mm)	19.6	10	25/100
YT-04792	PH3	50	1/4" (6.3 mm)	45.1	10	25/100



YATO	+	L [mm]	Hex	[Nm]	pcs / szt.	Box
YT-04812	PH2xPH2	65	1/4" (6.3 mm)	19.6 / 19.6	10	25/100

EN Screwdriver bit set  
PL Zestaw końcówek śrubokrętowych  
DE Schraubendreherbitsatz  
RU Набор битов  
CZ Sada šroubovacích bitů  
HU Csavarbit készlet  
RO Trusă biți  
FR Jeu d'embouts de tournevis  
IT Set punte per cacciavite  
ES Juego de puntas para atornillar  
CN 旋具头组套

**10** PCS  
**HRC 58-61**  
**AISI S2**  
COLD FORGED KUTE NA ZIMNO





|| 5, 6 mm;  
⊕ PH1, PH1, PH2, PH2;  
⊕ PZ1, PZ1, PZ2, PZ2

YATO 	L [mm]	⊕	pcs / szt.	
YT-04822	25	1/4" (6.3 mm)	10	25/200

EN Screwdriver bit  
PL Końcówka śrubokrętowa  
DE Schraubendreherbit  
RU Бит крестовая  
CZ Šroubováková koncovka  
HU Csavarhűzővég  
RO Capăt pt. șurubelniță  
FR Douille tournevis  
IT Punta del cacciavite  
ES Punta de destornilladora  
CN 十字旋具头





YATO 	⊕	L [mm]	⊕	[Nm]	pcs / szt.	
YT-78134	PZ1	25	1/4" (6.3 mm)	6.4	10	20/100
YT-78135	PZ2	25	1/4" (6.3 mm)	19.6	10	20/100
YT-78136	PZ3	25	1/4" (6.3 mm)	45.1	10	20/100

EN Screwdriver bit  
PL Końcówka śrubokrętowa  
DE Schraubendreherbit  
RU Бит крестовая  
CZ Šroubováková koncovka  
HU Csavarhűzővég  
RO Capăt pt. șurubelniță  
FR Douille tournevis  
IT Punta del cacciavite  
ES Punta de destornilladora  
CN 旋具头组套

**HRC 58-61**  
**AISI S2**  
COLD FORGED KUTE NA ZIMNO





YATO 	⊕	L [mm]	⊕	[Nm]	pcs / szt.	
YT-78151	PH1	50	1/4" (6.3 mm)	6.4	10	20/100
YT-78152	PH2	50	1/4" (6.3 mm)	19.6	10	20/100
YT-78153	PH3	50	1/4" (6.3 mm)	45.1	10	20/100

EN Screwdriver bit set  
PL Zestaw końcówek śrubokrętowych  
DE Schraubendreherbitsatz  
RU Набор битов  
CZ Sada šroubovacích bitů  
HU Csavarbit készlet  
RO Trusă biți  
FR Jeu d'embouts de tournevis  
IT Set punte per cacciavite  
ES Juego de puntas para atornillar  
CN 旋具头组套

**10** PCS  
**HRC 58-61**  
**AISI S2**  
COLD FORGED KUTE NA ZIMNO





|| 5, 6 mm;  
⊕ PH1, PH1, PH2, PH2;  
⊕ PZ1, PZ1, PZ2, PZ2



YATO 	L [mm]	⊕	pcs / szt.	
YT-04832	50	1/4" (6.3 mm)	10	25/100

**HRC 58-61**  
**AISI S2**  
COLD FORGED KUTE NA ZIMNO





YATO 	⊕	L [mm]	⊕	[Nm]	pcs / szt.	
YT-78130	PH0	25	1/4" (6.3 mm)	2.1	10	20/100
YT-78131	PH1	25	1/4" (6.3 mm)	7.8	10	20/100
YT-78132	PH2	25	1/4" (6.3 mm)	19.6	10	20/100
YT-78133	PH3	25	1/4" (6.3 mm)	45.6	10	20/100



YATO 	⊕	L [mm]	⊕	[Nm]	pcs / szt.	
YT-78141	T10	25	1/4" (6.3 mm)	5.9	10	20/100
YT-78142	T15	25	1/4" (6.3 mm)	8.4	10	20/100
YT-78143	T20	25	1/4" (6.3 mm)	14.7	10	20/100
YT-78144	T25	25	1/4" (6.3 mm)	21.6	10	20/100
YT-78145	T27	25	1/4" (6.3 mm)	29.4	10	20/100
YT-78146	T30	25	1/4" (6.3 mm)	45.1	10	20/100
YT-78147	T40	25	1/4" (6.3 mm)	76.5	10	20/100



YATO 	⊕	L [mm]	⊕	[Nm]	pcs / szt.	
YT-78154	PZ1	50	1/4" (6.3 mm)	6.4	10	20/100
YT-78155	PZ2	50	1/4" (6.3 mm)	19.6	10	20/100
YT-78156	PZ3	50	1/4" (6.3 mm)	45.1	10	20/100

EN Screwdriver bit set  
 PL Zestaw końcówek śrubokrętowych  
 DE Schraubendreherbitsatz  
 RU Набор битов

CZ Sada bitů  
 HU Bitkészlet  
 RO Truse bit  
 FR Embouts de vissage

IT Set punte cacciavite  
 ES Puntas de destornilladora  
 CN 旋具头组套



10 PCS

21.8 Nm (max.)

HRC 58-62

SAISI S2

COLD FORGED KUTE NA ZIMNO



YATO	+	L [mm]	⊕	📦
YT-0470	PZ1	25	1/4" (6.3 mm)	25/200
YT-0471	PZ2	25	1/4" (6.3 mm)	25/200
YT-0472	PZ3	25	1/4" (6.3 mm)	25/200

YATO	+	L [mm]	⊕	📦
YT-0477	PH1	50	1/4" (6.3 mm)	25/100
YT-0478	PH2	50	1/4" (6.3 mm)	25/100
YT-0480	PH2	75	1/4" (6.3 mm)	25/100



YATO	+	L [mm]	⊕	📦
YT-0474	PH1	25	1/4" (6.3 mm)	25/200
YT-0475	PH2	25	1/4" (6.3 mm)	25/200
YT-0476	PH3	25	1/4" (6.3 mm)	25/200

YATO	+	L [mm]	⊕	📦
YT-0481	PH2xPH2	65	1/4" (6.3 mm)	25/100

EN Screwdriver bit set  
 PL Zestaw końcówek śrubokrętowych  
 DE Schraubendreherbitsatz  
 RU Набор битов

CZ Sada bitů  
 HU Bitkészlet  
 RO Truse bit  
 FR Embouts de vissage

IT Set punte cacciavite  
 ES Puntas de destornilladora  
 CN 旋具头组套



10 PCS

21.8 Nm (max.)

HRC 58-62

SAISI S2

COLD FORGED KUTE NA ZIMNO



⊕ 1/4" (6.3 mm): 5, 6 mm (L=25 mm); AISI S2;  
 ⊕ 1/4" (6.3 mm): PH1 x2, PH2 x2 (L=25 mm); AISI S2;  
 ⊕ 1/4" (6.3 mm): PZ1 x2, PZ2 x2 (L=25 mm); AISI S2

⊕ 1/4" (6.3 mm): 5, 6 mm (L=50 mm); AISI S2;  
 ⊕ 1/4" (6.3 mm): PH1 x2, PH2 x2 (L=50 mm); AISI S2;  
 ⊕ 1/4" (6.3 mm): PZ1 x2, PZ2 x2 (L=50 mm); AISI S2

YATO	L [mm]	⊕	📦
YT-0482	25	1/4" (6.3 mm)	25/200

YATO	L [mm]	⊕	📦
YT-0483	25	1/4" (6.3 mm)	25/100

EN Screwdriver bit  
 PL Końcówka śrubokrętowa  
 DE Schraubendreherbit

RU Бит крестовая  
 CZ Šroubovavková koncovka  
 HU Csavarhűzővég

RO Capăt pt. șurubelniță  
 FR Douille tournevis  
 IT Punta del cacciavite

ES Punta de destornilladora  
 CN 旋具头组套



HRC 58-62

SAISI S2

COLD FORGED KUTE NA ZIMNO



YATO	+	L [mm]	⊕	pcs / szt.	📦
YT-7807	PH1	25	1/4" (6.3 mm)	50	20/40
YT-7808	PH2	25	1/4" (6.3 mm)	50	20/40
YT-7809	PH3	25	1/4" (6.3 mm)	50	20/40

YATO	+	L [mm]	⊕	pcs / szt.	📦
YT-7810	PZ1	25	1/4" (6.3 mm)	50	20/40
YT-7811	PZ2	25	1/4" (6.3 mm)	50	20/40
YT-7812	PZ3	25	1/4" (6.3 mm)	50	20/40

EN Screwdriver bit  
 PL Końcówka śrubokrętowa  
 DE Schraubendreherbit  
 RU Вставка-бита  
 CZ Šroubovavci bit  
 HU Csavarbit  
 RO Capăt pt. șurubelniță  
 FR Embout de tournevis  
 IT Punta per cacciavite  
 ES Punta de destornillador  
 CN 旋具头



• With limiter  
 • Z ogranicznikiem

YATO	L [mm]	⊕	pcs / szt.	📦
YT-7980	25	1/4" (6.3 mm)	20	20/40

EN Screwdriver bit  
PL Kończówka śrubokrętowa  
DE Schraubendreherbit  
RU Бит крестовая  
CZ Šroubováková koncovka  
HU Csavarhűzővég  
RO Capăt pt. șurubelniță  
FR Douille tournevis  
IT Punta del cacciavite  
ES Punta de destornilladora  
CN 旋具头组套

2 PCS  
1/4" 6.3 mm  
S2

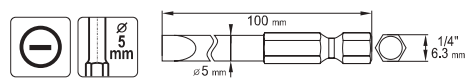

YATO	⊖ [mm]	L [mm]	⊕	📦
YT-0484	4, 5	100	1/4" (6.3 mm)	25/100

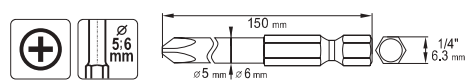
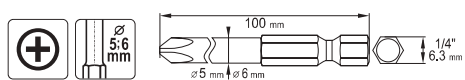

YATO	⊕	L [mm]	⊕	📦
YT-0488	PH1, PH2	100	1/4" (6.3 mm)	25/100

YATO	⊕	L [mm]	⊕	📦
YT-0489	PH1, PH2	150	1/4" (6.3 mm)	25/100

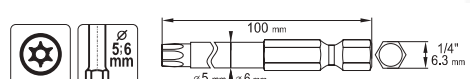
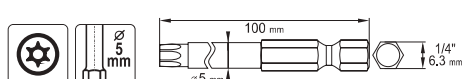

YATO	⊗	L [mm]	⊕	📦
YT-0490	T10, T25	100	1/4" (6.3 mm)	25/100

YATO	⊗	L [mm]	⊕	📦
YT-0491	T15, T27	100	1/4" (6.3 mm)	25/100
YT-0492	T20, T30	100	1/4" (6.3 mm)	25/100

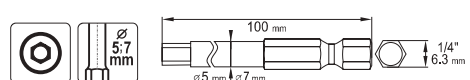
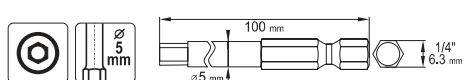

YATO	⊙ [mm]	L [mm]	⊕	📦
YT-0494	3, 5	100	1/4" (6.3 mm)	25/100

YATO	⊙ [mm]	L [mm]	⊕	📦
YT-0495	4, 6	100	1/4" (6.3 mm)	25/100

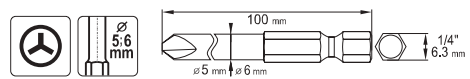
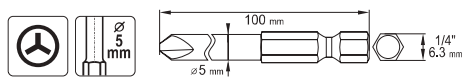
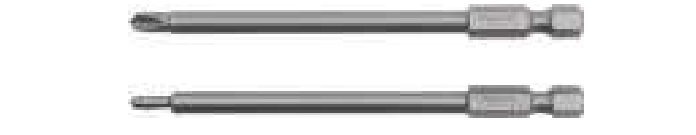

YATO	⊗ [mm]	L [mm]	⊕	📦
YT-0493	0, 1	100	1/4" (6.3 mm)	25/100
YT-0496	1, 3	100	1/4" (6.3 mm)	25/100

YATO	⊗ [mm]	L [mm]	⊕	📦
YT-0497	2, 4	100	1/4" (6.3 mm)	25/100

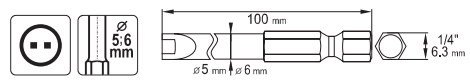
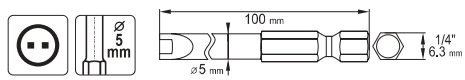

YATO	⊙ [mm]	L [mm]	⊕	📦
YT-0498	4, 8	100	1/4" (6.3 mm)	25/100

YATO	⊙ [mm]	L [mm]	⊕	📦
YT-0499	6, 10	100	1/4" (6.3 mm)	25/100

EN Screwdriver bit set  
 PL Zestaw końcówek śrubokrętowych  
 DE Schraubendreherbitsatz  
 RU Набор битов  
 CZ Sada šroubovacích bitů  
 HU Csavarbit készlet

RO Trusă biți  
 FR Jeu d'embouts de tournevis  
 IT Set punte per cacciavite  
 ES Juego de puntas para atornillar  
 CN 旋具头组套

40  
PCS





21.8  
Nm  
(max.)

HRC  
58-62

AISI  
S2



3/8" (9.5 mm): T20, T25, T30, T40, T45, T50, T55 (L=30 mm); T20, T25, T30, T40, T45, T50, T55 (L=75 mm); AISI S2;  
 3/8" (9.5 mm): 4, 5, 6, 7, 8, 10, 12 mm (L=30 mm); 4, 5, 6, 7, 8, 10, 12 mm (L=75 mm); AISI S2;  
 3/8" (9.5 mm): M5, M6, M8, M10, M12 (L=30 mm); M5, M6, M8, M10, M12 (L=75 mm); AISI S2;  
 1/2" (12.7 mm) x 3/8" (9.5 mm), 3/8" (9.5 mm) x 3/8" (9.5 mm); CrV 6150

**YATO**    
 YAT-0400 10

EN Screwdriver bit set  
 PL Zestaw końcówek śrubokrętowych  
 DE Schraubendreherbitsatz  
 RU Набор битов  
 CZ Sada šroubovacích bitů  
 HU Csavarbit készlet

RO Trusă biți  
 FR Jeu d'embouts de tournevis  
 IT Set punte per cacciavite  
 ES Juego de puntas para atornillar  
 CN 旋具头组套

7  
PCS





21.8  
Nm  
(max.)

HRC  
58-62

AISI  
S2



3/8" (9.5 mm): T25, T30, T40, T45, T50, T55 (L=30 mm); AISI S2;  
 1/2" (12.7 mm) x 3/8" (9.5 mm); CrV 6150

**YATO**    
 YAT-0410 24/72

EN Screwdriver bit set  
 PL Zestaw końcówek śrubokrętowych  
 DE Schraubendreherbitsatz  
 RU Набор битов  
 CZ Sada šroubovacích bitů  
 HU Csavarbit készlet

RO Trusă biți  
 FR Jeu d'embouts de tournevis  
 IT Set punte per cacciavite  
 ES Juego de puntas para atornillar  
 CN 旋具头组套

15  
PCS



21.8  
Nm  
(max.)

HRC  
58-62

AISI  
S2



3/8" (9.5 mm): T20, T25, T30, T40, T45, T50, T55 (L=30 mm); T20, T25, T30, T40, T45, T50, T55 (L=75 mm); AISI S2;  
 1/2" (12.7 mm) x 3/8" (9.5 mm); CrV 6150

**YATO**    
 YAT-0411 20

EN Screwdriver bit set  
 PL Zestaw końcówek śrubokrętowych  
 DE Schraubendreherbitsatz  
 RU Набор битов  
 CZ Sada šroubovacích bitů  
 HU Csavarbit készlet

RO Trusă biți  
 FR Jeu d'embouts de tournevis  
 IT Set punte per cacciavite  
 ES Juego de puntas para atornillar  
 CN 旋具头组套

7  
PCS



21.8  
Nm  
(max.)

HRC  
58-62

AISI  
S2



3/8" (9.5 mm): 4, 5, 6, 8, 10, 12 mm (L=30 mm); AISI S2;  
 1/2" (12.7 mm) x 3/8" (9.5 mm); CrV 6150

**YATO**    
 YAT-0412 24/72

EN Screwdriver bit set  
 PL Zestaw końcówek śrubokrętowych  
 DE Schraubendreherbitsatz  
 RU Набор битов  
 CZ Sada šroubovacích bitů  
 HU Csavarbit készlet

RO Trusă biți  
 FR Jeu d'embouts de tournevis  
 IT Set punte per cacciavite  
 ES Juego de puntas para atornillar  
 CN 旋具头组套

15  
PCS



21.8  
Nm  
(max.)

HRC  
58-62

AISI  
S2



3/8" (9.5 mm): 4, 5, 6, 7, 8, 10, 12 (L=30 mm); 4, 5, 6, 7, 8, 10, 12 (L=75 mm); AISI S2;  
 1/2" (12.7 mm) x 3/8" (9.5 mm); CrV 6150

**YATO**    
 YAT-0413 20

EN Screwdriver bit set  
 PL Zestaw końcówek śrubokrętowych  
 DE Schraubendreherbitsatz  
 RU Набор битов  
 CZ Sada šroubovacích bitů  
 HU Csavarbit készlet

RO Trusă biți  
 FR Jeu d'embouts de tournevis  
 IT Set punte per cacciavite  
 ES Juego de puntas para atornillar  
 CN 旋具头组套

6  
PCS



21.8  
Nm  
(max.)

HRC  
58-62

AISI  
S2



3/8" (9.5 mm): M5, M6, M8, M10, M12 (L=30 mm); AISI S2;  
 1/2" (12.7 mm) x 3/8" (9.5 mm); CrV 6150

**YATO**    
 YAT-0414 24/72

EN Screwdriver bit set  
PL Zestaw końcówek śrubokrętowych  
DE Schraubendreherbitsatz  
RU Набор битов  
CZ Sada šroubovacích bitů  
HU Csavarbit készlet

RO Trusă biți  
FR Jeu d'embouts de tournevis  
IT Set punte per cacciavite  
ES Juego de puntas para atornillar  
CN 旋具头组套

11  
PCS



21.8  
Nm  
(max.)

HRC  
58-62

AISI  
S2



3/8" (9.5 mm): M5, M6, M8, M10, M12 (L=30 mm); M5, M6, M8, M10, M12 (L=75 mm); AISI S2;  
1/2" (12.7 mm) x 3/8" (9.5 mm); CrV 6150

**YATO** **YT-0415** 20

EN Screwdriver bit set  
PL Zestaw końcówek śrubokrętowych  
DE Schraubendreherbitsatz  
RU Набор битов  
CZ Sada šroubovacích bitů  
HU Csavarbit készlet

RO Trusă biți  
FR Jeu d'embouts de tournevis  
IT Set punte per cacciavite  
ES Juego de puntas para atornillar  
CN 旋具头组套

15  
PCS



21.8  
Nm  
(max.)

HRC  
58-62

AISI  
S2



3/8" (9.5 mm): T20, T25, T30, T40, T45, T50, T55 (L=30 mm);  
T20, T25, T30, T40, T45, T50, T55 (L=75 mm); AISI S2;  
1/2" (12.7 mm) x 3/8" (9.5 mm); CrV 6150

**YATO** **YT-0417** 20

EN Screwdriver bit set  
PL Zestaw końcówek śrubokrętowych  
DE Schraubendreherbitsatz  
RU Набор битов  
CZ Sada šroubovacích bitů  
HU Csavarbit készlet

RO Trusă biți  
FR Jeu d'embouts de tournevis  
IT Set punte per cacciavite  
ES Juego de puntas para atornillar  
CN 旋具头组套

15  
PCS



21.8  
Nm  
(max.)

HRC  
58-62

AISI  
S2



3/8" (9.5 mm): M6, M7, M8, M9, M10, M12, M14 (L=30 mm);  
M6, M7, M8, M9, M10, M12, M14 (L=75 mm); AISI S2;  
1/2" (12.7 mm) x 3/8" (9.5 mm); CrV 6150

**YATO** **YT-0419** 20

EN Screwdriver bit set  
PL Zestaw końcówek śrubokrętowych  
DE Schraubendreherbitsatz  
RU Набор битов  
CZ Sada šroubovacích bitů  
HU Csavarbit készlet

RO Trusă biți  
FR Jeu d'embouts de tournevis  
IT Set punte per cacciavite  
ES Juego de puntas para atornillar  
CN 旋具头组套

7  
PCS



21.8  
Nm  
(max.)

HRC  
58-62

AISI  
S2



3/8" (9.5 mm): T25, T30, T40, T45, T50, T55 (L=30 mm); AISI S2;  
1/2" (12.7 mm) x 3/8" (9.5 mm); CrV 6150

**YATO** **YT-0416** 24/72

EN Screwdriver bit set  
PL Zestaw końcówek śrubokrętowych  
DE Schraubendreherbitsatz  
RU Набор битов  
CZ Sada šroubovacích bitů  
HU Csavarbit készlet

RO Trusă biți  
FR Jeu d'embouts de tournevis  
IT Set punte per cacciavite  
ES Juego de puntas para atornillar  
CN 旋具头组套

8  
PCS



21.8  
Nm  
(max.)

HRC  
58-62

AISI  
S2



3/8" (9.5 mm): M5, M6, M7, M8, M10, M12, M14 (L=30 mm); AISI S2;  
1/2" (12.7 mm) x 3/8" (9.5 mm); CrV 6150

**YATO** **YT-0418** 24/72

EN Screwdriver bit set  
PL Zestaw końcówek śrubokrętowych  
DE Schraubendreherbitsatz  
RU Набор битов  
CZ Sada šroubovacích bitů  
HU Csavarbit készlet

RO Trusă biți  
FR Jeu d'embouts de tournevis  
IT Set punte per cacciavite  
ES Juego de puntas para atornillar  
CN 旋具头组套

42  
PCS



21.8  
Nm  
(max.)

HRC  
58-62

AISI  
S2



3/8" (9.5 mm): T20, T25, T30, T40, T45, T50, T55, T60, T70 (L=30 mm);  
T20, T25, T30, T40, T45, T50, T55, T60, T70 (L=75 mm); AISI S2;  
3/8" (9.5 mm): M4, M5, M6, M7, M8, M9, M10, M11, M12, M13, M14 (L=30 mm);  
M4, M5, M6, M7, M8, M9, M10, M11, M12, M13, M14 (L=75 mm); AISI S2;  
1/2" (12.7 mm) x 3/8" (9.5 mm), 3/8" (9.5 mm) x 3/8" (9.5 mm); CrV 6150

**YATO** **YT-0420** 10

EN Screwdriver bit set  
 PL Zestaw końcówek śrubokrętowych  
 DE Schraubendreherbitsatz  
 RU Набор битов

CZ Sada šroubovacích bitů  
 HU Csavarbit készlet  
 RO Trusă biți  
 FR Jeu d'embouts de tournevis

IT Set punte per cacciavite  
 ES Juego de puntas para atornillar  
 CN 旋具头组套



23 PCS 1/4" 6.3mm

S2

- ⊕ 1/4" (6.3 mm): PH0, PH2 x2, PH3 (L=25 mm); PH2 (L=50 mm); S2;
- ⊕ 1/4" (6.3 mm): PZ0, PZ2 x2, PZ3 (L=25 mm); PZ2 (L=50 mm); S2;
- ⊕ 1/4" (6.3 mm): T20 x2, T25 x2, T30 x2, T40 (L=25 mm); T20, T30 (L=50 mm); S2;
- 1/4" (6.3 mm): 4, 5, 6 mm (L=25 mm); S2;
- 1/4" (6.3 mm); (L=60 mm); CrV

**YATO** YT-04621 20

EN Screwdriver bit set  
 PL Zestaw końcówek śrubokrętowych  
 DE Schraubendreherbitsatz  
 RU Набор битов

CZ Sada šroubovacích bitů  
 HU Csavarbit készlet  
 RO Trusă biți  
 FR Jeu d'embouts de tournevis

IT Set punte per cacciavite  
 ES Juego de puntas para atornillar  
 CN 旋具头组套



32 PCS 1/4" 6.3mm

S2

- 1/4" (6.3 mm): 3, 4, 5, 6 mm (L=25 mm); S2;
- ⊕ 1/4" (6.3 mm): PH1, PH2 x2, PH3 (L=25 mm); S2;
- ⊕ 1/4" (6.3 mm): PZ1, PZ2 x2, PZ3 (L=25 mm); S2;
- ⊕ 1/4" (6.3 mm): T10, T15, T20, T25, T27, T30, T40 (L=25 mm); S2;
- ⊕ 1/4" (6.3 mm): T10, T15, T20, T25, T27, T30, T40 (L=25 mm); S2;
- 1/4" (6.3 mm): 3, 4, 5, 6 mm (L=25 mm); S2;
- 1/4" (6.3 mm); (L=70 mm); CrV;
- ⊕ 1/4" (6.3 mm); (L=25 mm); S2

**YATO** YT-04622 20

EN Screwdriver bit set  
 PL Zestaw końcówek śrubokrętowych  
 DE Schraubendreherbitsatz  
 RU Набор битов

CZ Sada šroubovacích bitů  
 HU Csavarbit készlet  
 RO Trusă biți  
 FR Jeu d'embouts de tournevis

IT Set punte per cacciavite  
 ES Juego de puntas para atornillar  
 CN 旋具头组套



34 PCS 1/4" 6.3mm

S2

- 1/4" (6.3 mm): 5, 6, 7, 8, 9, 10, 11, 12 mm (L=25 mm);
- 1/4" (6.3 mm); (L=75 mm);
- 1/4" (6.3 mm): 3, 4, 5.5 x2, 6.5 x2 mm (L=25 mm); S2;
- ⊕ 1/4" (6.3 mm): PH1 x2, PH2 x2, PH3 x2 (L=25 mm); S2;
- ⊕ 1/4" (6.3 mm): PZ1 x2, PZ2 x2, PZ3 x2 (L=25 mm); S2;
- ⊕ 1/4" (6.3 mm): T10, T15, T20, T25, T27, T30 (L=25 mm); S2;
- 1/4" (6.3 mm); (L=60 mm); CrV

**YATO** YT-04623 20

EN Screwdriver bit set  
 PL Zestaw końcówek śrubokrętowych  
 DE Schraubendreherbitsatz  
 RU Набор битов  
 CZ Sada šroubovacích bitů  
 HU Csavarbit készlet

RO Trusă biți  
 FR Jeu d'embouts de tournevis  
 IT Set punte per cacciavite  
 ES Juego de puntas para atornillar  
 CN 旋具头组套



40 PCS 1/4" 6.3mm

S2

- 1/4" (6.3 mm): 3, 4, 5, 6, 7 mm (L=25 mm); S2;
- ⊕ 1/4" (6.3 mm): PH0, PH1, PH2, PH3 (L=25 mm); PH1, PH2 (L=50 mm); S2;
- ⊕ 1/4" (6.3 mm): PZ0, PZ1, PZ2, PZ3 (L=25 mm); PZ1, PZ2 (L=50 mm); S2;
- ⊕ 1/4" (6.3 mm): T8, T10, T15, T20, T25, T27, T30, T40 (L=25 mm); S2;
- 1/4" (6.3 mm): 2, 2.5, 3, 4, 5, 5.5, 6 x2 mm (L=25 mm); S2;
- 1/4" (6.3 mm): S1, S2, S3 (L=25 mm); S2;
- ⊕ 1/4" (6.3 mm): 5 mm x PH1, 6 mm x PH2, 6 mm x PH3 (L=65 mm); S2;
- ⊕ 1/4" (6.3 mm): PH2 x PH2, PH2 x PH3 (L=65 mm); S2;
- ⊕ 1/4" (6.3 mm): PZ1 x PZ1, PZ2 x PZ2, PZ3 x PZ3 (L=65 mm); S2;
- 1/4" (6.3 mm); (L=60 mm); S2

**YATO** YT-04620 20

EN Screwdriver bit set  
PL Zestaw końcówek śrubokrętowych  
DE Schraubendreherbitsatz  
RU Набор битов

CZ Sada šroubovacích bitů  
HU Csavarbit készlet  
RO Trusă biți  
FR Jeu d'embouts de tournevis

IT Set punte per cacciavite  
ES Juego de puntas para atornillar  
CN 旋具头组套

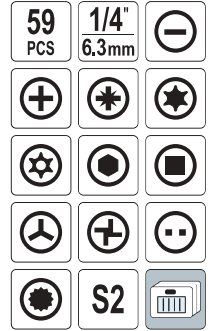

- 1/4" (6.3 mm): 2, 4, 6.5 mm (L=25 mm); S2;
- 1/4" (6.3 mm): PH0, PH1 x2, PH2 x2, PH3 (L=25 mm); S2;
- 1/4" (6.3 mm): PZ1 x2, PZ2 x2, PZ3 (L=25 mm); S2;
- 1/4" (6.3 mm): T10, T15, T20, T25, T30, T40 (L=25 mm); S2;
- 1/4" (6.3 mm): T8, T9, T10, T15, T20, T25, T27, T30, T40 (L=25 mm); S2;
- 1/4" (6.3 mm): 2, 2.5, 3, 4, 5, 6, 8 mm (L=25 mm); S2;
- 1/4" (6.3 mm): 0, 1, 2, 3 mm (L=25 mm); S2;
- 1/4" (6.3 mm): 1, 2, 3, 4 mm (L=25 mm); S2;
- 1/4" (6.3 mm): 6, 8, 10 mm (L=25 mm); S2;
- 1/4" (6.3 mm): 4, 6, 8, 10 mm (L=25 mm); S2;
- 1/4" (6.3 mm): M5, M6, M8 (L=25 mm); S2;
- 1/4" (6.3 mm): C1, C2, C3 (L=25 mm); S2;
- 1/4" (6.3 mm): (L=70 mm); CrV;
- 1/4" (6.3 mm); CrV

**YATO**  
YT-04624

20

EN Nut setter  
PL Nasadka magnetyczna do wkrętarki  
DE Magnet-Steckschlüssel mit Adapter  
RU Магнитная головка для винтовёрта  
CZ Nástrčný kľúč magnetický do vrtačky  
HU Csavarbehajtó  
RO Cheie tubulara cu prindere tip mandrina  
FR Douille tournevis magnétique  
IT Cappuccio magnetico la vite  
ES Boquilla magnética de destornilladora  
CN 磁性套筒

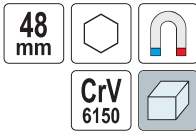

YATO	ø [mm]	
YT-1501	6	200/600
YT-1502	7	200/600
YT-1503	8	200/600
YT-1505	10	200/600
YT-1507	12	200/600
YT-1508	13	200/600

EN Nut setter  
PL Nasadka magnetyczna do wkrętarki  
DE Magnet-Steckschlüssel mit Adapter  
RU Магнитная головка для винтовёрта  
CZ Nástrčný kľúč magnetický do vrtačky  
HU Csavarbehajtó  
RO Cheie tubulara cu prindere tip mandrina  
FR Douille tournevis magnétique  
IT Cappuccio magnetico la vite  
ES Boquilla magnética de destornilladora  
CN 磁性套筒

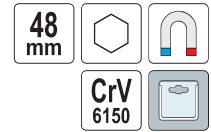

YATO	ø [mm]	
YT-1511	6	100/200
YT-1512	7	100/200
YT-1513	8	100/200
YT-1515	10	100/200
YT-1517	12	100/200
YT-1518	13	100/200

EN Screwdriver bit holder  
PL Uchwyt do końcówek śrubokrętowych  
DE Bithalter

RU Магнитный держатель  
CZ Držák na šroubovavkovékoncovky  
HU Szár a csavarhúzóvégéhez

RO Capete șurubelniță  
FR Mandrin magnétique  
IT Mandrino portapunta

ES Mandril para puntas  
CN 旋具头磁性接杆



YATO	ø [mm]	L [mm]	
YT-0465	1/4" (6.3 mm)	60	20/200

YATO	ø [mm]	L [mm]	
YT-0466	1/4" (6.3 mm)	60	20/200



YATO	ø [mm]	L [mm]	
YT-0467	1/4" (6.3 mm)	80	20/200

YATO	ø [mm]	L [mm]	
YT-04671	1/4" (6.3 mm)	120	100

EN Screwdriver bit holder  
 PL Uchwyt do końcówek śrubokrętowych  
 DE Bithalter  
 RU Магнитный держатель  
 CZ Držák na šroubovakovékoncovky  
 HU Szár a csavarhúzóvégkehez  
 RO Capete șurubelniță  
 FR Mandrin magnétique  
 IT Mandrino portapunta  
 ES Mandril para puntas  
 CN 旋具头磁性接杆

1/4" 6.3mm 60mm QUICK RELEASE SZYBKO-ZŁĄCZE SS STAINLESS STEEL STYL NIEODŻYWIWA



<b>YATO</b>	1/4" (6.3 mm)	L [mm]	20/200
YT-0468		60	

EN Screwdriver bit holder  
 PL Uchwyt do końcówek śrubokrętowych  
 DE Bithalter  
 RU Магнитный держатель  
 CZ Držák na šroubovakovékoncovky  
 HU Szár a csavarhúzóvégkehez  
 RO Capete șurubelniță  
 FR Mandrin magnétique  
 IT Mandrino portapunta  
 ES Mandril para puntas  
 CN 螺丝批头接杆

1/4" 6.3mm 150mm CrV



<b>YATO</b>	1/4" (6.3 mm)	L [mm]	100
YT-04695		150	

EN Swivel bit holder  
 PL Adapter kątowy do bitów  
 DE Gelenk-Bit-Adapter  
 RU Адаптер для бит шарнирный  
 CZ Držák na bity s jističím  
 HU Csuklós bit befogó  
 RO Bit pivotant  
 FR Porte embout pivotant  
 IT Adattatore angolare per punte  
 ES Adaptador articulado para puntas  
 CN 万向接杆

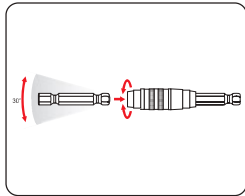

1/4" 6.3mm 100mm CrV



<b>YATO</b>	1/4" (6.3 mm)	60/120
YT-04635		

EN Keyless chuck snap-out  
 PL Uchwyt wiertarski bezkluczkowy  
 DE Schnellspan-Bohrfutter  
 RU Патрон для дрели быстросъемной  
 CZ Sklíčidlo  
 HU Bitbefogású gyorsstokmány  
 RO Mandrina rapidă cu coada  
 FR Mandrin sans clé  
 IT Mandrino portapunte autoserrante  
 ES Adaptador portabrocas  
 CN 夹头

1/4" 6.3mm 0.5-3.0mm 50mm



<b>YATO</b>	1/4" (6.3 mm)	50/150
YT-04644		

EN Keyless chuck snap-out  
 PL Uchwyt wiertarski bezkluczkowy  
 DE Schnellspan-Bohrfutter  
 RU Патрон для дрели быстросъемной  
 CZ Sklíčidlo  
 HU Bitbefogású gyorsstokmány  
 RO Mandrina rapidă cu coada  
 FR Adaptador portabrocas  
 IT Mandrino portapunte autoserrante  
 ES Mandrin sans clé  
 CN 夹头

1/4" 6.3mm 0.5-6.5mm 75mm



<b>YATO</b>	1/4" (6.3 mm)	10/60
YT-04645		

EN Screwdriver bit holder  
 PL Uchwyt do końcówek śrubokrętowych  
 DE Bithalter  
 RU Магнитный держатель  
 CZ Držák na šroubovakovékoncovky  
 HU Szár a csavarhúzóvégkehez

1/4" 6.3mm



<b>YATO</b>	1/4" (6.3 mm)	L [mm]	50/100
YT-04681		150	
YT-04682		200	
YT-04683		250	
YT-04684		300	

EN Screwdriver bit holder set  
 PL Zestaw uchwytów do bitów  
 DE Bithalter-Set  
 RU Набор держателей бит  
 CZ Sada prodlužovacích úchytů pro bity  
 HU Bitbefogó készlet  
 RO Set prelungitoare biti  
 FR Jeu de porte-embouts  
 IT Kit portainseriti  
 ES Juego de portaherramientas  
 CN 延长杆组套

3 PCS 1/4" 6.3mm



1/4" (6.3 mm): 75, 100, 150 mm

<b>YATO</b>	1/4" (6.3 mm)	20/120
YT-04699		

EN Adapter  
 PL Adapter  
 DE Adapter  
 RU Адаптер

CZ Adaptér  
 HU Adapter  
 RO Adaptor  
 FR Adaptateur

1/4" 6.3mm 1/4" 6.3mm 65mm



<b>YATO</b>	1/4" (6.3 mm)	L [mm]	40/120
YT-04625		65	

EN Adapter  
 PL Adapter  
 DE Adapter  
 RU Адаптер

CZ Adaptér  
 HU Adapter  
 RO Adaptor  
 FR Adaptateur

1/4" 6.3mm 3/8" 9.5mm 65mm CrV



<b>YATO</b>	1/4" (6.3 mm)	L [mm]	40/120
YT-04626		65	

EN Adapter  
 PL Adapter  
 DE Adapter  
 RU Адаптер

CZ Adaptér  
 HU Adapter  
 RO Adaptor  
 FR Adaptateur

1/4" 6.3mm 1/2" 12.7mm 70mm CrV







<b>YATO</b>	1/4" (6.3 mm)	L [mm]	40/120
YT-04627		70	

EN Adapter  
PL Adapter  
DE Adapter  
RU Адаптер

CZ Adaptér  
HU Adapter  
RO Adaptor  
FR Adaptateur

IT Adattatore  
ES Adaptador  
CN 转接杆

<b>3</b> PCS	 1/4" 6.3 mm	 1/4" 6.3 mm	 3/8" 9.5 mm
 1/2" 12.7 mm	<b>150</b> mm	<b>CrV</b>	

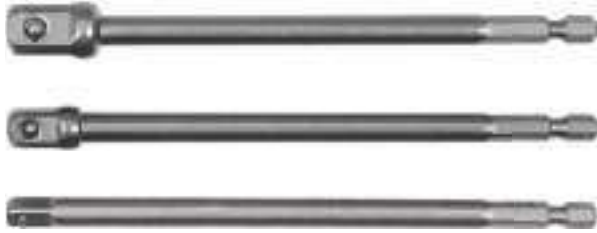





<b>YATO</b> 		L [mm]	
YT-04628	1/4" (6.3 mm)	150	24

EN Adapter  
PL Adapter  
DE Adapter  
RU Адаптер



CZ Adaptér  
HU Adapter  
RO Adaptor  
FR Adaptateur

IT Adattatore  
ES Adaptador  
CN 转接杆

<b>8</b> PCS	 1/4" 6.3 mm	 3/8" 9.5 mm
 1/2" 12.7 mm		







1/2" (12.7 mm): 50, 72 mm; 3/8" (9.5 mm): 50, 65 mm; 1/4" (6.3 mm): 25, 30, 50, 65 mm

<b>YATO</b> 		L [mm]	
YT-04639	1/4" (6.3 mm), 3/8" (9.5 mm), 1/2" (12.7 mm)		20/100

EN Adapter  
PL Adapter  
DE Adapter  
RU Адаптер

CZ Adaptér  
HU Adapter  
RO Adaptor  
FR Adaptateur

IT Adattatore  
ES Adaptador  
CN 接杆组套

<b>SDS PLUS</b>	 1/4" 6.3 mm	 3/8" 9.5 mm
 1/2" 12.7 mm	<b>65</b> mm	

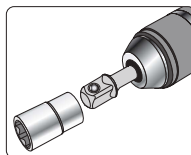



<b>YATO</b> 		
YT-04686		20/100

EN Adapter  
PL Adapter  
DE Adapter  
RU Адаптер

CZ Adaptér  
HU Adapter  
RO Adaptor  
FR Adaptateur

IT Adattatore  
ES Adaptador  
CN 接杆

 1/4" 6.3 mm	<b>SDS PLUS</b>	<b>60</b> mm
		

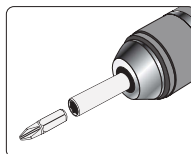

<b>YATO</b> 	L [mm]	
YT-04690	60	50/100

EN Adapter  
PL Adapter  
DE Adapter  
RU Адаптер

CZ Adaptér  
HU Adapter  
RO Adaptor  
FR Adaptateur

IT Adattatore  
ES Adaptador  
CN 转接杆

<b>6</b> PCS	 1/4" 6.3 mm	 1/4" 6.3 mm	 3/8" 9.5 mm
 1/2" 12.7 mm	<b>50</b> mm	<b>150</b> mm	<b>CrV</b>



<b>YATO</b> 		L [mm]	
YT-04629	1/4" (6.3 mm)	50, 150	24



EN Adapter  
PL Adapter  
DE Adapter  
RU Адаптер

CZ Adaptér  
HU Adapter  
RO Adaptor  
FR Adaptateur

IT Adattatore  
ES Adaptador  
CN 六角柄接杆组套

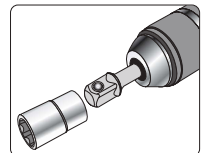
 1/4" 6.3 mm	 1/4" 6.3 mm	 3/8" 9.5 mm
 1/2" 12.7 mm	<b>65</b> mm	<b>73</b> mm





<b>YATO</b> 		
YT-04685	1/4" (6.3 mm)	20/100

EN Universal joint bit adapter set  
PL Zestaw adapterów z przegubem  
DE Kreuzgelenk-Adapter-Set  
RU Набор переходников с шарниром  
CZ Sada adaptérů s kloubem  
HU Csuklós csavarhúzófé-adapter  
RO Set de adaptoare cardanice  
FR Jeu d'adapteurs avec joint  
IT Kit adattatori con giunto  
ES Conjunto de adaptadores con junta articulada  
CN 万向接杆

<b>3</b> PCS	 1/4" 6.3 mm	 1/4" 6.3 mm	 3/8" 9.5 mm	 1/2" 12.7 mm
				





**CrV**  
50BV30

<b>YATO</b> 		
YT-04641	1/4" (6.3 mm)	12/36

EN Extension bar  
PL Przedłużka elastyczna  
DE Verlängerung  
RU Удлинитель для воротка  
CZ Prodlužovací příravek  
HU Toldalék

RO Prelungitor  
FR Rallonge élastique  
IT Prolunga flessibile  
ES Tubo de prolongación  
CN 可弯式接杆

 1/4" 6.3 mm	<b>150</b> mm	<b>CrV</b> 6140
		

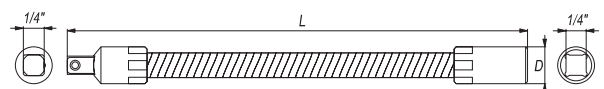

<b>YATO</b> 			D [mm]	L [mm]	PCS PC/RE	
YT-1400	1/4" (6.3 mm)	1/4" (6.3 mm)	11.6	150	25 250/500	

EN Extension bar  
 PL Przedłużka elastyczna  
 DE Verlängerung  
 RU Удлинитель для воротка  
 CZ Prodlužovací přípravek  
 HU Toldalék  
 RO Prelungitor  
 FR Rallonge élastique  
 IT Prolunga flessibile  
 ES Tubo de prolongación  
 CN 柔性螺丝批头接杆

**1/4"**  
6.3mm  
**300**  
mm  
**CrV**  
6140

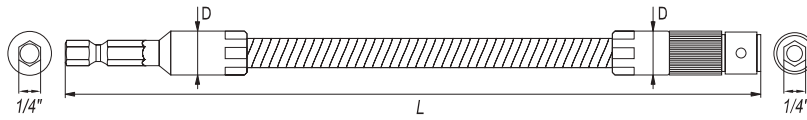

YATO	⊘	⊘	D [mm]	L [mm]	
YT-14001	1/4" (6.3 mm)	1/4" (6.3 mm)	11.7	300	100

5

EN Angled screwdriver bit holder  
 PL Wkręтак kątowy do końcówek śrubokrętowych  
 DE Winkelschrauber  
 RU Г-образный держатель для бит  
 CZ Šroubovák  
 HU Csavarhúzó  
 RO Prelungitor pt. biti, 90 grade  
 FR Mandrin magnétique  
 IT Cacciavite ad angolo per punte  
 ES Porta puntas magnético  
 CN 直角螺丝批接头

**1/4"**  
6.3 mm  
**105**  
mm  
**90°**



YATO	⊘	L [mm]	
YT-04630	1/4" (6.3 mm)	105	60/240

EN Angle adapter  
 PL Adapter kątowy  
 DE Winkelschrauber  
 RU Адаптер угловой для бит  
 CZ Úhel elektrická vrtačka připojení adaptéru  
 HU Sarokcsavarozó adapter  
 RO Dispozitiv unghiular de insurubat  
 FR Renvoi d'angle perceuse visseuse  
 IT Adattatore  
 ES Ángulo magnético bit driver adaptador  
 CN 拐批带柔性接杆

**1/4"**  
6.3 mm  
**37**  
mm  
**105°**  
**12**  
Nm  
  
**1200**  
min<sup>-1</sup>  
**SS**  
STAINLESS STEEL  
STAL NERZEWA

EN Angle adapter  
 PL Adapter kątowy  
 DE Winkelschrauber  
 RU Адаптер угловой для бит  
 CZ Úhel elektrická vrtačka připojení adaptéru  
 HU Sarokcsavarozó adapter  
 RO Dispozitiv unghiular de insurubat  
 FR Renvoi d'angle perceuse visseuse  
 IT Adattatore  
 ES Ángulo magnético bit driver adaptador  
 CN 拐批螺丝批接头



YATO	⊘	L [mm]	
YT-04632	1/4" (6.3 mm)	37	100

EN Angle adapter with extension  
 PL Adapter kątowy z przedłużką  
 DE Winkelschrauber  
 RU Адаптер угловой для бит  
 CZ Úhel elektrická vrtačka připojení adaptéru  
 HU Sarokcsavarozó adapter  
 RO Dispozitiv unghiular de insurubat  
 FR Renvoi d'angle perceuse visseuse  
 IT Adattatore  
 ES Ángulo magnético bit driver adaptador  
 CN 拐批带柔性接杆

**1/4"**  
6.3 mm  
**325**  
mm  
**400**  
min<sup>-1</sup>  
**90°**  
**13**  
Nm



YATO	⊘	L [mm]	
YT-04636	1/4" (6.3 mm)	325	10/60

EN Angle adapter  
 PL Adapter kątowy  
 DE Winkelschrauber  
 RU Адаптер угловой для бит  
 CZ Úhel elektrická vrtačka připojení adaptéru  
 HU Sarokcsavarozó adapter  
 RO Dispozitiv unghiular de insurubat  
 FR Renvoi d'angle perceuse visseuse  
 IT Adattatore  
 ES Ángulo magnético bit driver adaptador  
 CN 带手柄拐批螺丝批接头

**1/4"**  
6.3 mm  
**155**  
mm  
**400**  
min<sup>-1</sup>  
**90°**  
**13**  
Nm



YATO	⊘	L [mm]	
YT-04631	1/4" (6.3 mm)	155	50

EN Impact adapter  
 PL Adapter udarowy do bitów  
 DE Schlag-Bit-Adapter  
 RU Ударный адаптер для бит  
 CZ Nárazový adaptér pro bity  
 HU Ütvefű adapter bitfejekhez  
 RO Adaptor impact  
 FR Adaptateur de percussion pour embouts  
 IT Adattatore a impatto per punte  
 ES Adaptador de impacto para bites  
 CN 转接头

**1/4"**  
6.3 mm  
**1/2"**  
12.7 mm  
**50**  
mm



YATO	⊘	L [mm]	
YT-04691	1/4" (6.3 mm)	50	10/60

EN T-handle key  
PL Klucz typu „T”  
DE T-Griff Stiftschlüssel  
RU Ключ Т-образный с рукояткой

CZ Imbusový klíč s T-rukojetí  
HU Imbuskulcs T-markolattal  
RO Cheie tip „T”  
FR Clé allen avec en „T”

IT Chiave a „T” per viti con impronta  
ES Llave allen con mango en „T”  
CN T型内六角扳手

S2



YATO	⌀ [mm]	a [mm]	b [mm]	c [mm]	
YT-05571	2.5	13	76	100	12/240
YT-05572	3.0	13	76	100	12/240
YT-05574	4.0	13	76	140	12/240
YT-05576	5.0	17	92	140	12/144
YT-05577	6.0	17	92	170	12/144
YT-05578	7.0	17	92	170	12/144
YT-05579	8.0	22	102	200	12/96
YT-05581	10.0	22	102	200	12/96

YATO	⌀ [mm]	a [mm]	b [mm]	c [mm]	
YT-05585	2.5	13	76	100	12/240
YT-05586	3.0	13	76	100	12/240
YT-05588	4.0	13	76	140	12/240
YT-05590	5.0	17	92	140	12/144
YT-05591	6.0	17	92	170	12/144
YT-05592	7.0	17	92	170	12/144
YT-05593	8.0	22	102	200	12/96
YT-05594	10.0	22	102	200	12/96

YATO	⌀ [mm]	a [mm]	b [mm]	c [mm]	
YT-05601	T8	13	76	100	12/240
YT-05602	T9	13	76	100	12/240
YT-05603	T10	13	76	100	12/240
YT-05604	T15	13	76	100	12/240
YT-05605	T20	13	76	130	12/240
YT-05606	T25	13	76	130	12/240
YT-05607	T27	17	92	140	12/144
YT-05608	T30	17	92	170	12/144
YT-05609	T40	17	92	170	12/144
YT-05610	T45	22	102	200	12/96
YT-05611	T50	22	102	200	12/96

EN T-handle key  
PL Klucz typu „T”  
DE T-Griff Stiftschlüssel  
RU Ключ Т-образный с рукояткой

CZ Imbusový klíč s T-rukojetí  
HU Imbuskulcs T-markolattal  
RO Cheie tip „T”  
FR Clé allen avec en „T”

IT Chiave a „T” per viti con impronta  
ES Llave allen con mango en „T”  
CN T型内六角扳手组套

8  
PCS



S2



YATO	⌀ [mm]	a [mm]	b [mm]	c [mm]	
YT-05583	2.5, 3, 4, 5, 6, 7, 8, 10	13, 13, 13, 17, 17, 17, 22, 22	76, 76, 76, 92, 92, 92, 102, 102	100, 100, 140, 140, 170, 170, 200, 200	12/24

YATO	⌀ [mm]	a [mm]	b [mm]	c [mm]	
YT-05597	2.5, 3, 4, 5, 6, 7, 8, 10	13, 13, 13, 17, 17, 17, 22, 22	76, 76, 76, 92, 92, 92, 102, 102	100, 100, 140, 140, 170, 170, 200, 200	12/24

- EN T-handle key
- PL Klucz typu „T”
- DE T-Griff Stiftschlüssel
- RU Ключ Т-образный с рукояткой
- CZ Imbusový klíč s T-rukojetí
- HU Imbuskulcs T-markolattal
- RO Cheie tip „T”
- FR Clé Allen avec en „T”
- IT Chiave a „T” per viti con impronta
- ES Llave Allen con mango en „T”
- CN T型星型内六角扳手组套

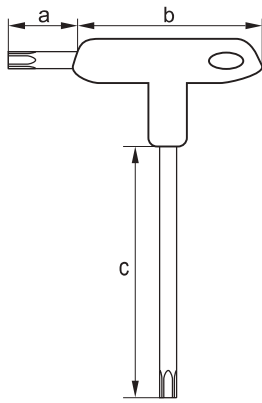

9  
PCS

S2



YATO	⊙	a [mm]	b [mm]	c [mm]	📦
YT-05615	T10, T15, T20,	13, 13, 13, 13,	76, 76, 76, 76,	100, 100, 100,	12/24
	T25, T27, T30,	17, 17, 17,	92, 92, 92, 102,	140, 140, 170,	
	T40, T45, T50	22, 22	102	170, 200, 200	

- EN Hex and Torx key set
- PL Zestaw kluczy trzpieniowych
- DE Sechskant und Torx Stiftschlüsselsatz
- RU Набор ключей Hex и Torx
- CZ Sada klíčů imbusových a Torx
- HU Kulcskészlet imbisz és Torx
- RO Set de chei imbus și Torx
- FR Ensemble clés Hex et Torx
- IT Set di chiavi a brugola
- ES Juego de llaves hexagonales y Torx
- CN 内六角组套



24  
PCS

CrV

- ⊙ 1.5, 2, 2.5, 3, 4, 5, 6, 8 mm; 1/16" (1.6 mm), 5/64" (2.0 mm), 3/32" (2.4 mm), 1/8" (3.2 mm), 9/64" (3.6 mm), 5/32" (4.0 mm), 3/16" (4.8 mm), 1/4" (6.3 mm); CrV;
- ⊙ T6, T7, T8, T9, T10, T15, T20, T25; CrV

YATO	📦
YT-05640	10/40

- EN Hex and Torx key set
- PL Zestaw kluczy trzpieniowych
- DE Sechskant und Torx Stiftschlüsselsatz
- RU Набор ключей Hex и Torx
- CZ Sada klíčů imbusových a Torx
- HU Kulcskészlet imbisz és Torx
- RO Set de chei imbus și Torx
- FR Ensemble clés Hex et Torx
- IT Set di chiavi a brugola
- ES Juego de llaves hexagonales y Torx
- CN 内六角组套

26  
PCS

CrV



- ⊙ 1.5, 2, 2.5, 3, 4, 4.5, 5, 5.5, 6 mm; 5/64" (2.0 mm), 3/32" (2.4 mm), 7/64" (2.8 mm), 1/8" (3.2 mm), 9/64" (3.6 mm), 5/32" (4.0 mm), 3/16" (4.8 mm), 7/32" (5.6 mm), 1/4" (6.3 mm); CrV;
- ⊙ T9, T10, T15, T20, T25, T27, T30, T40; CrV

YATO	📦
YT-05644	6/20

- EN Hex key
- PL Klucz sześciokątny
- DE Sechskant-Stiftschlüssel
- RU Шестигранный
- CZ Imbusový klíč
- HU Imbisz kulcs
- RO Cheie imbus
- FR Clé Allen
- IT Chiave a brugola
- ES Llave hexagonal
- CN 六角螺丝批

LONG  
DLUGI

CrV

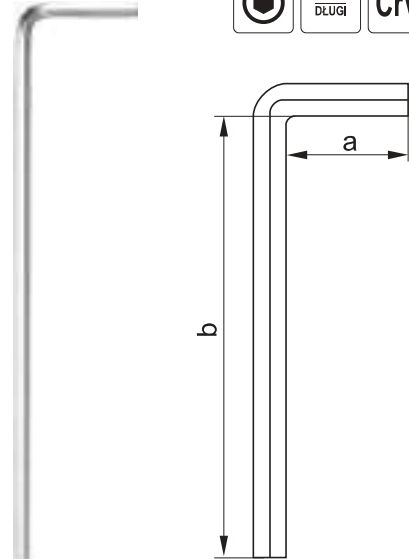

YATO	⊙ [mm]	a [mm]	b [mm]	📦
YT-05430	1.5	14	78	250/2000
YT-05431	2.0	16	83	250/2000
YT-05432	2.5	18	90	250/1500
YT-05433	3.0	20	100	250/1500
YT-05434	4.0	25	105	250/1000
YT-05436	5.0	27	116	100/600
YT-05438	6.0	32	137	100/500
YT-05439	7.0	34	150	100/300
YT-05440	8.0	36	155	50/200
YT-05441	9.0	38	165	25/125
YT-05442	10.0	40	170	25/125
YT-05443	12.0	47	210	25/75
YT-05444	14.0	57	236	25/50
YT-05445	17.0	63	250	15/30
YT-05446	19.0	70	280	10/20

EN Hex key  
PL Klucz sześciokątny  
DE Sechskant-Stiftschlüssel  
RU Шестигранный  
CZ Imbusový klíč  
HU Imbissz kulcs  
RO Cheie imbus  
FR Clé Allen  
IT Chiave a brugola  
ES Llave hexagonal  
CN 六角螺丝批

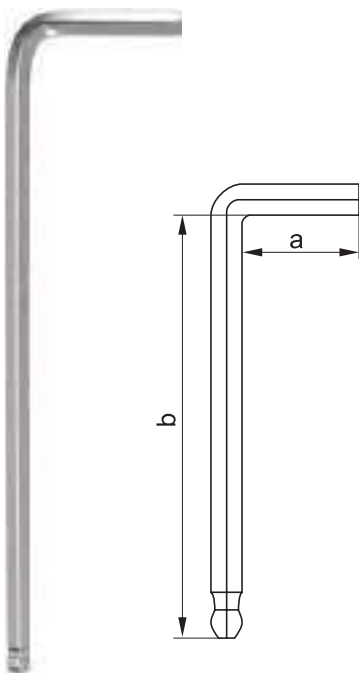

YATO	⊙ [mm]	a [mm]	b [mm]	
YT-05450	1.5	14	78	250/2000
YT-05451	2.0	16	83	250/2000
YT-05452	2.5	18	90	250/2000
YT-05453	3.0	20	100	250/1500
YT-05454	4.0	25	105	250/1000
YT-05456	5.0	27	116	100/600
YT-05458	6.0	32	137	100/500
YT-05459	7.0	34	150	100/300
YT-05460	8.0	36	155	50/200
YT-05461	9.0	38	165	25/125
YT-05462	10.0	40	170	25/125
YT-05463	12.0	47	210	25/75
YT-05464	14.0	57	236	25/50
YT-05465	17.0	63	250	15/30
YT-05466	19.0	70	280	10/20

EN Torx key  
PL Klucz Torx  
DE Torx-Stiftschlüssel  
RU Ключ Torx  
CZ Klíč Torx  
HU Kulcs Torx  
RO Cheie Torx  
FR Clé Torx  
IT Chiave Torx  
ES Llave Torx  
CN 内六角螺丝批

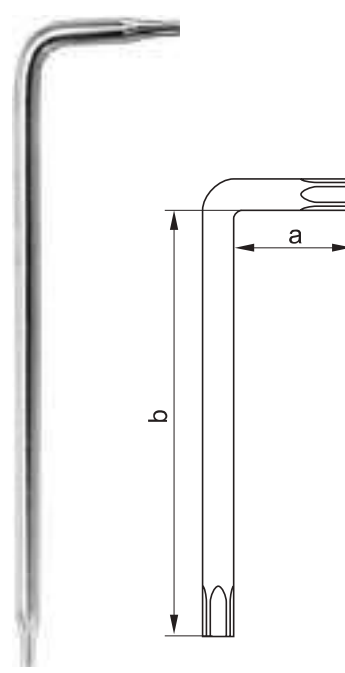

YATO	⊙	a [mm]	b [mm]	
YT-05490	T6	16	66	250/2000
YT-05491	T7	16	71	250/2000
YT-05492	T8	16	80	250/2000
YT-05493	T9	16	80	250/2000
YT-05494	T10	17	86	250/2000
YT-05495	T15	17	90	250/2000
YT-05496	T20	19	95	100/1000
YT-05497	T25	20	100	250/1000
YT-05498	T27	21	105	100/1000
YT-05499	T30	24	114	50/600
YT-05501	T40	28	121	50/400

EN Torx key  
PL Klucz Torx  
DE Torx-Stiftschlüssel  
RU Ключ Torx  
CZ Klíč Torx  
HU Kulcs Torx  
RO Cheie Torx  
FR Clé Torx  
IT Chiave Torx  
ES Llave Torx  
CN 内六角螺丝批

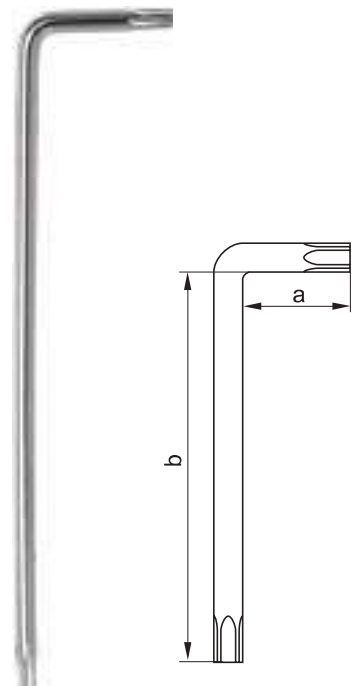

YATO	⊙	a [mm]	b [mm]	
YT-05514	T10	17	86	250/2000
YT-05515	T15	17	90	250/2000
YT-05516	T20	19	95	250/1000
YT-05517	T25	20	100	250/1000
YT-05518	T27	21	105	250/1000
YT-05519	T30	24	114	50/600
YT-05520	T40	28	121	50/400

EN Torx key set  
PL Zestaw kluczy Torx  
DE Torx-Stiftschlüsselsatz  
RU Набор ключей Torx  
CZ Souprava klíčů Torx  
HU Torx kulcskészlet  
RO Set de chei Torx  
FR Set de clés Torx  
IT Set di chiavi a brugola Torx  
ES Juego de llaves Torx  
CN 内六角螺丝批

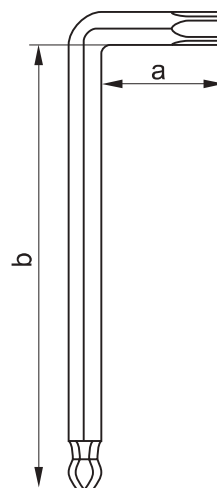

YATO	⊙	a [mm]	b [mm]	
YT-05123	T9, T10, T15, T20, T25, T27, T30, T40	18, 18, 19, 20, 21, 23, 25, 27	85, 90, 95, 100, 107, 115, 123, 132	10/100

EN Hex key set  
 PL Zestaw kluczy imbusowych  
 DE Sechskant-Stiftschlüsselsatz  
 RU Набор шестигранников  
 CZ Imbusové klíče  
 HU Imbisz kulcs  
 RO Chei imbus  
 FR Set de clés allen  
 IT Set di chiavi a brugola  
 ES Juego de llaves hex  
 CN 内六角扳手组套

**12**  
PCS

**SAE**

**CrV**  
6150

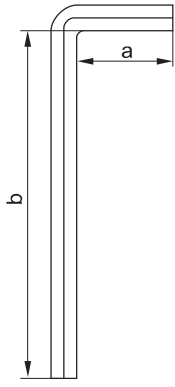

**25°**

**LONG**  
DEUGI

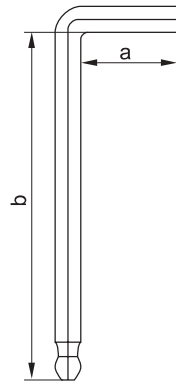

**25°**

**EXTRA**  
**LONG**  
**EKSTRA**  
**DEUGI**

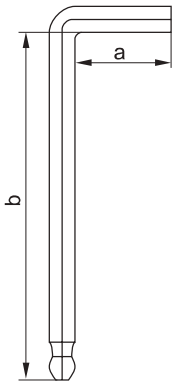

YATO	⊙	a [mm]	b [mm]	
YT-5835	1/16" (1.6 mm),			6/36
	5/64" (2.0 mm),			
	3/32" (2.4 mm),			
	7/64" (2.8 mm),		74, 79, 83,	
	1/8" (3.2 mm),	14, 16, 17,	88, 93, 99,	
	9/64" (3.6 mm),	18, 19, 20,	105, 113,	
	5/32" (4.0 mm),	21, 24, 25,	122, 132,	
	3/16" (4.8 mm),	28, 32, 35	150, 170	
	7/32" (5.6 mm),			
	1/4" (6.3 mm),			
	5/16" (7.9 mm),			
	3/8" (9.5 mm)			

YATO	⊙	a [mm]	b [mm]	
YT-5837	1/16" (1.6 mm),			6/36
	5/64" (2.0 mm),			
	3/32" (2.4 mm),			
	7/64" (2.8 mm),		74, 79, 83,	
	1/8" (3.2 mm),	14, 16, 17,	88, 93, 99,	
	9/64" (3.6 mm),	18, 19, 20,	105, 113,	
	5/32" (4.0 mm),	21, 24, 25,	122, 132,	
	3/16" (4.8 mm),	28, 32, 35	150, 170	
	7/32" (5.6 mm),			
	1/4" (6.3 mm),			
	5/16" (7.9 mm),			
	3/8" (9.5 mm)			

YATO	⊙	a [mm]	b [mm]	
YT-5838	1/16" (1.6 mm),			6/36
	5/64" (2.0 mm),			
	3/32" (2.4 mm),			
	7/64" (2.8 mm),		91, 100,	
	1/8" (3.2 mm),	14, 16, 17,	110, 116,	
	9/64" (3.6 mm),	18, 19, 20,	123, 130,	
	5/32" (4.0 mm),	21, 24, 25,	132, 150,	
	3/16" (4.8 mm),	28, 32, 35	165, 185,	
	7/32" (5.6 mm),		200, 233	
	1/4" (6.3 mm),			
	5/16" (7.9 mm),			
	3/8" (9.5 mm)			

EN Hex key set  
 PL Zestaw kluczy imbusowych  
 DE Sechskant-Stiftschlüsselsatz  
 RU Набор шестигранников  
 CZ Imbusové klíče  
 HU Imbisz kulcs  
 RO Chei imbus  
 FR Set de clés allen  
 IT Set di chiavi a brugola  
 ES Juego de llaves hex  
 CN 内六角扳手组套

**HRC**  
52-56

**CrV**  
6150

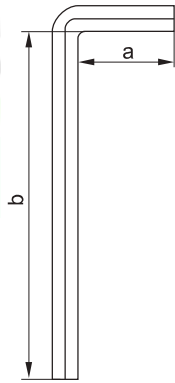

**9**  
PCS

YATO	⊙ [mm]	a [mm]	b [mm]	
YT-0500	1.5, 2, 2.5, 3, 4, 5,	15, 16, 18, 21, 23, 28,	74, 81, 88, 95, 109,	6/36
	6, 8, 10	31, 35, 39	121, 135, 157, 174	

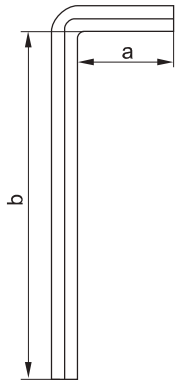
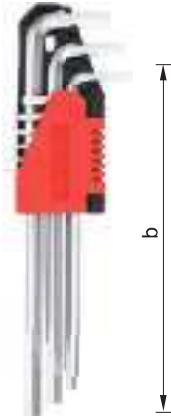

**9**  
PCS

YATO	⊙ [mm]	a [mm]	b [mm]	
YT-0501	1.5, 2, 2.5, 3, 4, 5,	15, 16, 18, 21, 23, 28,	90, 96, 112, 125, 142,	6/36
	6, 8, 10	31, 35, 39	157, 180, 201, 225	

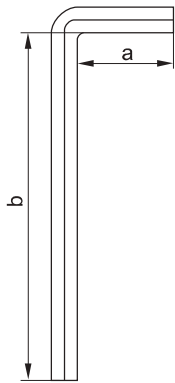

**9**  
PCS

YATO	⊙ [mm]	a [mm]	b [mm]	
YT-0502	2, 2.5, 3, 4, 5, 6, 7,	16, 18, 21, 23, 28, 31,	81, 88, 95, 109, 121,	6/36
	8, 10	33, 35, 39	135, 145, 157, 174	

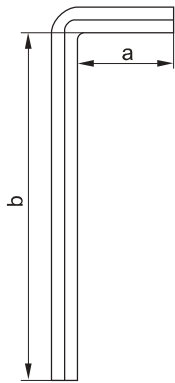

**10**  
PCS

YATO	⊙ [mm]	a [mm]	b [mm]	
YT-0508	2, 2.5, 3, 4, 5, 6, 7, 8,	16, 18, 21, 23, 28, 31,	81, 88, 95, 109, 121,	6/36
	10, 12	33, 35, 39, 42	135, 145, 157, 174, 180	

EN Hex key set  
PL Zestaw kluczy imbusowych  
DE Sechskant-Stiftschlüsselsatz  
RU Набор шестигранных

CZ Imbusové klíče  
HU Imbisz kulcs  
RO Chei imbus  
FR Set de clés allen

IT Set di chiavi a brugola  
ES Juego de llaves hex  
CN 内六角扳手组套



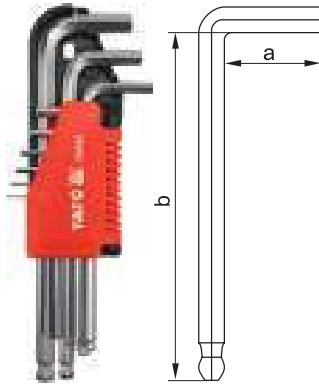

HRC  
52-56

CrV  
6150



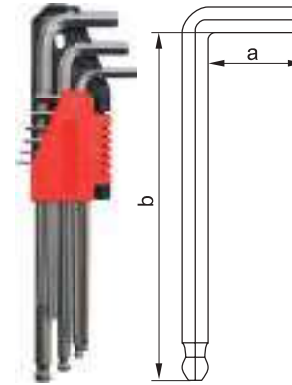

9  
PCS 

YATO 	⌀ [mm]	a [mm]	b [mm]	
YT-0505	1.5, 2, 2.5, 3, 4, 5, 6, 8, 10	15, 16, 18, 21, 23, 28, 31, 35, 39	74, 81, 88, 95, 109, 121, 135, 157, 174	6/36



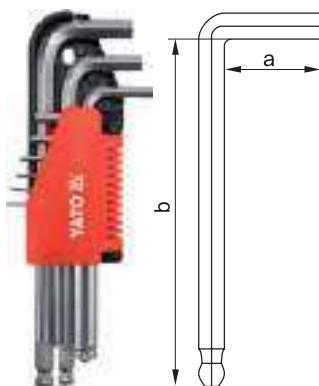

9  
PCS

YATO 	⌀ [mm]	a [mm]	b [mm]	
YT-0506	1.5, 2, 2.5, 3, 4, 5, 6, 8, 10	15, 16, 18, 21, 23, 28, 31, 35, 39	90, 96, 112, 125, 142, 157, 180, 201, 225	6/36



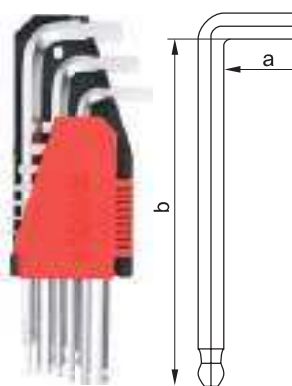

9  
PCS

YATO 	⌀ [mm]	a [mm]	b [mm]	
YT-0507	2, 2.5, 3, 4, 5, 6, 7, 8, 10	16, 18, 21, 23, 28, 31, 33, 35, 39	81, 88, 95, 109, 121, 135, 145, 157, 174	6/36



10  
PCS

YATO 	⌀ [mm]	a [mm]	b [mm]	
YT-0509	2, 2.5, 3, 4, 5, 6, 7, 8, 10, 12	16, 18, 21, 23, 28, 31, 33, 35, 39, 42	81, 88, 95, 109, 121, 135, 145, 157, 174, 180	6/36

EN Hex key set  
PL Zestaw kluczy imbusowych  
DE Sechskant-Stiftschlüsselsatz  
RU Набор шестигранных

CZ Imbusové klíče  
HU Imbisz kulcs  
RO Chei imbus  
FR Set de clés allen



IT Set di chiavi a brugola  
ES Juego de llaves hex  
CN 内六角组套



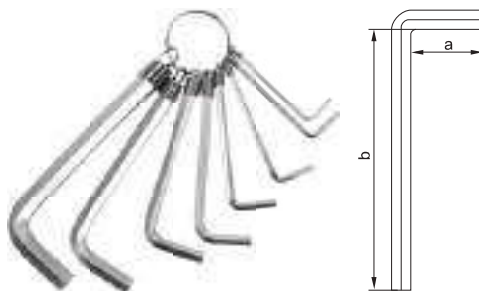

CrV  
6150



8  
PCS

YATO 	⌀ [mm]	a [mm]	b [mm]	
YT-0503	2, 2.5, 3, 4, 5, 6, 8, 10	14, 16, 17, 21, 22, 27, 32, 38	50, 53, 60, 66, 74, 81, 93, 104	12/72

10  
PCS

YATO 	⌀ [mm]	a [mm]	b [mm]	
YT-0504	1.5, 2, 2.5, 3, 4, 5, 6, 7, 8, 10	12, 14, 16, 17, 21, 22, 27, 31, 32, 38	43, 50, 53, 60, 66, 74, 81, 86, 93, 104	12/72

EN Hex key set  
PL Zestaw kluczy imbusowych  
DE Sechskant-Stiftschlüsselsatz  
RU Набор шестигранных  
CZ Imbusové klíče  
HU Imbisz kulcs  
RO Chei imbus  
FR Set de clés Allen  
IT Set di chiavi a brugola  
ES Juego de llaves Hex  
CN 内六角扳手组套

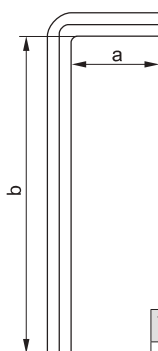



10  
PCS



HRC  
52-55

CrV  
6150



YATO 	⌀ [mm]	a [mm]	b [mm]	
YT-0519	3, 4, 5, 5.5, 6, 8, 10, 12, 14, 17	20, 25, 28, 30, 32, 35, 42, 49, 57, 65	125, 140, 160, 170, 180, 200, 220, 250, 285, 320	5

5

EN TORX key set  
 PL Zestaw kluczy TORX  
 DE TORX-Stiftschlüsselsatz  
 RU Набор ключей TORX

CZ Souprava klíčů TORX  
 HU Kulcskészlet, TORX  
 RO Set de chei TORX  
 FR Set de clés allen

IT Set di chiavi a brugola  
 ES Juego de llaves TORX  
 CN 内六角扳手组套

9  
PCS



HRC  
52-56

CrV  
6150

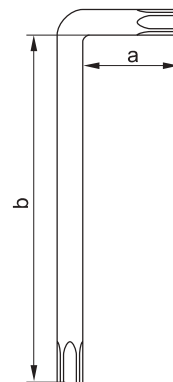
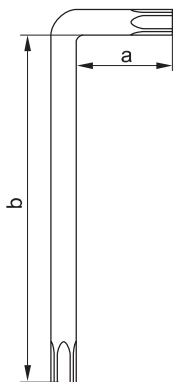

YATO	⊙	a [mm]	b [mm]	☐
YT-0511	T10, T15, T20, T25, T27, T30, T40, T45, T50	15, 16, 17, 21, 24, 27, 32, 36, 38	72, 79, 86, 94, 107, 122, 133, 155, 174	6/36

YATO	⊙	a [mm]	b [mm]	☐
YT-0512	T10, T15, T20, T25, T27, T30, T40, T45, T50	15, 16, 19, 23, 26, 27, 32, 36, 41	78, 95, 109, 124, 143, 153, 180, 200, 222	6/36

EN Hex key set  
 PL Zestaw kluczy imbusowych  
 DE Sechskant-Stiftschlüsselsatz  
 RU Набор шестигранных

CZ Imbusové klíče  
 HU Imbisz kulcs  
 RO Chei imbus  
 FR Set de clés allen

IT Set di chiavi a brugola  
 ES Juego de llaves hex  
 CN 内六角组套

10  
PCS



S2

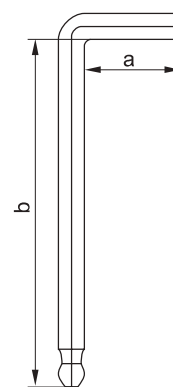
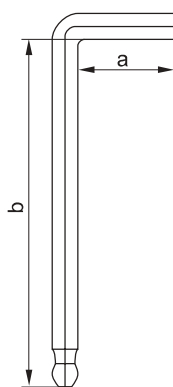

YATO	⊙ [mm]	a [mm]	b [mm]	☐
YT-0560	1.27, 1.5, 2, 2.5, 3, 4, 5, 6, 8, 10	12, 14, 16, 18, 18, 21, 27, 32, 35, 38	73, 76, 82, 89, 99, 104, 115, 138, 161, 179	12/48

YATO	⊙ [mm]	a [mm]	b [mm]	☐
YT-0561	1.27, 1.5, 2, 2.5, 3, 4, 5, 6, 8, 10	10, 12, 15, 17, 19, 23, 28, 32, 36, 50	78, 89, 98, 110, 124, 140, 159, 179, 198, 232	12/48

EN TORX key set  
 PL Zestaw kluczy TORX  
 DE TORX-Stiftschlüsselsatz  
 RU Набор ключей TORX

CZ Souprava klíčů TORX  
 HU Kulcskészlet, TORX  
 RO Set de chei TORX  
 FR Set de clés allen

IT Set di chiavi a brugola  
 ES Juego de llaves TORX  
 CN 内六角组套



S2

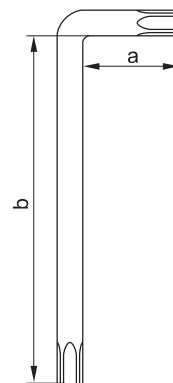
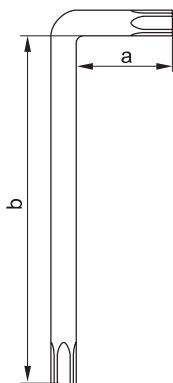

7  
PCS

YATO	⊙	a [mm]	b [mm]	☐
YT-0562	T9, T10, T15, T20, T25, T27, T30	18, 19, 19, 19, 22, 24, 26	78, 85, 93, 103, 113, 123, 132	12/48



9  
PCS

YATO	⊙	a [mm]	b [mm]	☐
YT-0563	T10, T15, T20, T25, T27, T30, T40, T45, T50	14, 14, 16, 18, 23, 27, 30, 35, 41	87, 97, 108, 123, 137, 158, 177, 197, 216	12/48

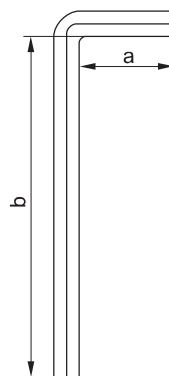
- EN Hex key set
- PL Zestaw kluczy imbusowych
- DE Sechskant-Stiftschlüsselsatz
- RU Набор ключи торцовых шестигранных
- CZ Imbusové klíče
- HU Imbissz kulcs
- RO Chei imbus
- FR Set de clés allen
- IT Set di chiavi a brugola
- ES Llaves hexagonales
- CN 内六角扳手组套



9 PCS	
LONG DEUGI	HRC 58-62
S2	

YATO 	© [mm]	a [mm]	b [mm]	
YT-05631	1.5, 2, 2.5, 3, 4, 5, 6, 8, 10	14.5, 16, 17.5, 21, 23, 27, 30, 33, 38	78.5, 83, 90.5, 99, 110, 122, 138, 152, 166	10/50

- EN Hex key set
- PL Zestaw kluczy imbusowych
- DE Sechskant-Stiftschlüsselsatz
- RU Набор ключи торцовых шестигранных
- CZ Imbusové klíče
- HU Imbissz kulcs
- RO Chei imbus
- FR Set de clés allen
- IT Set di chiavi a brugola
- ES Llaves hexagonales
- CN 内六角扳手组套

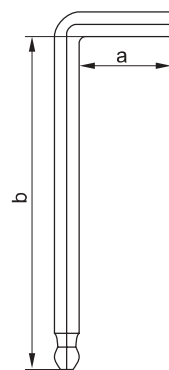



9 PCS	
25° 	LONG DEUGI
HRC 58-62	S2
	

YATO 	© [mm]	a [mm]	b [mm]	
YT-05632	1.5, 2, 2.5, 3, 4, 5, 6, 8, 10	14.5, 16, 17.5, 21, 23, 27, 30, 33, 38	78.5, 83, 90.5, 99, 110, 122, 138, 152, 166	10/50

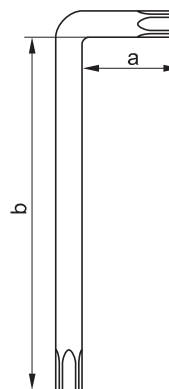
- EN Torx key set
- PL Zestaw kluczy Torx
- DE Torx Schlüsselsatz
- RU Набор ключи Torx
- CZ Souprava klíčů Torx
- HU Kulcskészlet Torx
- RO Set de chei Torx
- FR Set de clés Torx
- IT Set di chiavi a brugola Torx
- ES Juego de llaves Torx
- CN 内六角扳手组套



9 PCS	
LONG DEUGI	HRC 58-62
S2	

YATO 	©	a [mm]	b [mm]	
YT-05633	T10, T15, T20, T25, T27, T30, T40, T45, T50	15, 17.7, 19.2, 20.75, 23.25, 25.5, 28.2, 34.2, 36.2	83, 90.7, 98.2, 106.75, 113.25, 129.5, 139.2, 149.2, 161.2	10/50