

Sockets 1/4" Klucze nasadowe 1/4"		23
---	---	----

Hexagonal sockets Klucze nasadowe sześciokątne, krótkie	23
Hexagonal deep sockets Klucze nasadowe sześciokątne, długie	23

Accessories 1/4" Akcesoria 1/4"		23-25
---	---	-------

Extension bars Przedłużki	23
Extension bars with wobble Przedłużki uchyłne	24
Adapters Redukcje	24
Bit adapters Adaptory do bitów	24
Universal joints Przeguby Cardana	24
Spinner handles Pokręta do nasadek	24
Sliding T-bars Pokręta typu „T”	25
Flexible handles Pokręta łamane	25

Ratchet handles 1/4" Grzechotki 1/4"		25-26
--	--	-------

Ratchet handles Grzechotki	25
Flexible ratchet handles Grzechotki z przegubem	25
Composite ratchet handles Grzechotki powlekane	26
Curved ratchet handles Grzechotki wygięte	26
Telescopic ratchet handles Grzechotki z przedłużonym uchwytem	26
Bit and socket drive ratchet handles Grzechotki do bitów i nasadek	26

Sockets 3/8" Klucze nasadowe 3/8"		27
---	---	----

Hexagonal sockets Klucze nasadowe sześciokątne, krótkie	27
Hexagonal deep sockets Klucze nasadowe sześciokątne, długie	27

Accessories 3/8" Akcesoria 3/8"		27-28
---	---	-------

Extension bars Przedłużki	27
Extension bars with wobble Przedłużki uchyłne	27
Adapters Redukcje	28
Bit adapters Adaptory do bitów	28
Universal joints Przeguby Cardana	28

Sliding T-bars Pokręta typu „T”	28
Flexible handles Pokręta łamane	28

Ratchet handles 3/8" Grzechotki 3/8"		29
--	---	----

Ratchet handles Grzechotki	29
Flexible ratchet handles Grzechotki z przegubem	29
Composite ratchet handles Grzechotki powlekane	29
Curved ratchet handles Grzechotki wygięte	29
Telescopic ratchet handles Grzechotki z przedłużonym uchwytem	29

Sockets 1/2" Klucze nasadowe 1/2"		30-31
---	---	-------

Hexagonal sockets Klucze nasadowe sześciokątne, krótkie	30
Bi-hexagonal sockets Klucze nasadowe dwunastokątne, krótkie	30
Spline sockets Klucze nasadowe „Spline”	30
Hexagonal deep sockets Klucze nasadowe sześciokątne, długie	31
Bi-hexagonal deep sockets Klucze nasadowe dwunastokątne, długie	31

Accessories 1/2" Akcesoria 1/2"		31-32
---	---	-------

Extension bars Przedłużki	31
Extension bars with wobble Przedłużki uchyłne	31
Adapters Redukcje	31
Bit adapters Adaptory do bitów	32
Universal joints Przeguby Cardana	32
Sliding T-bars Pokręta typu „T”	32
Flexible handles Pokręta łamane	32
L-type handles Pokręta typu „L”	32

Ratchet handles 1/2" Grzechotki 1/2"		33
--	---	----

Ratchet handles Grzechotki	33
Flexible ratchet handles Grzechotki z przegubem	33
Composite ratchet handles Grzechotki powlekane	33
Curved ratchet handles Grzechotki wygięte	33
Telescopic ratchet handles Grzechotki z przedłużonym uchwytem	33



Socket sets Zestawy kluczy nasadowych		34-47
---	---	-------

Socket sets 1/4" Zestawy kluczy nasadowych 1/4"	34
Socket sets 3/8" Zestawy kluczy nasadowych 3/8"	35
Socket sets 1/2" Zestawy kluczy nasadowych 1/2"	36
Socket sets 1/2", 1/4" Zestawy kluczy nasadowych 1/2", 1/4"	37
Socket sets 1/2", 3/8", 1/4" Zestawy kluczy nasadowych 1/2", 3/8", 1/4"	41

Socket sets Zestawy kluczy nasadowych		48
---	---	----

Socket sets 1/4" Zestawy kluczy nasadowych 1/4"	48
Socket sets 1/2" Zestawy kluczy nasadowych 1/2"	48
Socket sets 1/2", 3/8" Zestawy kluczy nasadowych 1/2", 3/8"	48

Tool sets Zestawy narzędziowe		49
---	---	----

Torx sockets & sets Klucze nasadowe „Torx” i zestawy		49-50
--	---	-------

Sockets 3/4" Klucze nasadowe 3/4"		50
---	---	----

Accessories 3/4" Akcesoria 3/4"		51-52
---	---	-------

Extension bars Przedłużki	51
Adapters Redukcje	51
Universal joints Przeguby Cardana	51
Sliding T-bars Pokręta typu „T”	51
Flexible handles Pokręta łamane	51
L-type handles Pokręta typu „L”	52

Ratchet handles 3/4" Grzechotki 3/4"		52
--	---	----

Socket sets 3/4" Zestawy kluczy nasadowych 3/4"		52
---	---	----

Bit sockets & sets 1/4", 3/8", 1/2" Klucze trzpieniowe i zestawy 1/4", 3/8", 1/2"		53-58
---	---	-------

EN Hexagonal socket
PL Nasadka sześciokątna
DE Sechskantenschlüssel
RU Головка шестигранная короткая
CZ Šestihranný nástavec
HU Dugókulcs hatszög
RO Cheie tubulară hexagonală
FR Douille courte
IT Chiave a bussola esagonale
ES Boquilla hexagonal corta
CN 六角套筒

1/4"
6.3mm
DIN 3121
CrV 50BV30
AS-DRIVE

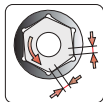
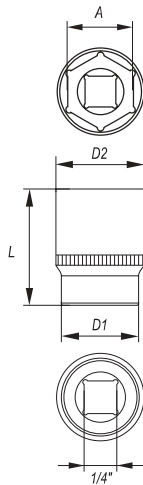

• Drive locks
• Surface finish: chromed, satin / mirror
• Zamki blokujące
• Wykończenie powierzchni: chromowana, satynowa / polerowana

YATO	o A [mm]	D1 [mm]	D2 [mm]	L [mm]	PCS POMIĘ	
YT-1401	4.0	7.0	12	25	24	240/480
YT-1403	5.0	8.0	12	25	24	240/480
YT-1404	5.5	8.5	12	25	24	240/480
YT-1405	6.0	9.0	12	25	24	240/480
YT-1406	7.0	10.0	12	25	24	240/480
YT-1407	8.0	12.0	11	25	24	240/480
YT-1408	9.0	13.0	12	25	24	240/480
YT-1409	10.0	15.0	12	25	24	240/480
YT-1410	11.0	16.0	14	25	24	240/480
YT-1411	12.0	17.0	15	25	24	240/480
YT-1412	13.0	18.0	16	25	24	240/480

EN Hexagonal deep socket
PL Nasadka sześciokątna długa
DE Sechskantenschlüssel, lange
RU Головка шестигранная длинная
CZ Šestihranný hluboký nástavec
HU Dugókulcs hatszög hosszú
RO Cheie tubulară hexagonală adâncă
FR Douille longue
IT Chiave a bussola esagonale
ES Boquilla hexagonal larga
CN 六角长套筒

1/4"
6.3mm
DIN 3121
CrV 50BV30
AS-DRIVE

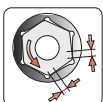
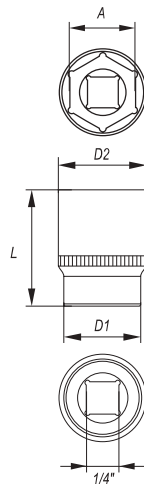

• Drive locks
• Surface finish: chromed, satin / mirror
• Zamki blokujące
• Wykończenie powierzchni: chromowana, satynowa / polerowana

YATO	o A [mm]	D1 [mm]	D2 [mm]	L [mm]	PCS POMIĘ	
YT-1413	4.0	7.0	12	50	24	240/480
YT-1414	4.5	7.5	12	50	24	240/480
YT-1415	5.0	8.0	12	50	24	240/480
YT-1416	5.5	8.5	12	50	24	240/480
YT-1417	6.0	9.0	12	50	24	240/480
YT-1418	7.0	10.0	12	50	24	240/480
YT-1419	8.0	12.0	12	50	24	240/480
YT-1420	9.0	13.0	12	50	24	240/480
YT-1421	10.0	14.0	13	50	24	240/480
YT-1422	11.0	16.0	14	50	24	120/240
YT-1423	12.0	17.0	15	50	24	120/240
YT-1424	13.0	18.0	16	50	24	120/240

EN Hexagonal socket
PL Nasadka sześciokątna
DE Sechskantenschlüssel
RU Головка шестигранная короткая
CZ Šestihranný nástavec
HU Dugókulcs hatszög
RO Cheie tubulară hexagonală
FR Douille courte
IT Chiave a bussola esagonale
ES Boquilla hexagonal corta
CN 六角套筒

1/4"
6.3mm
CrV 50BV30
AS-DRIVE

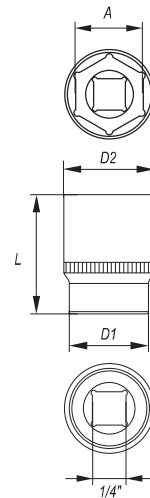

YATO	o A [mm]	D1 [mm]	D2 [mm]	L [mm]	PCS POMIĘ
YT-14120	5.0	8.0	12	25	12/360
YT-14121	5.5	8.5	12	25	12/360
YT-14123	6.0	9.0	12	25	12/360
YT-14124	7.0	10.0	12	25	12/360
YT-14125	8.0	12.0	12	25	6/360
YT-14126	9.0	13.0	12	25	6/360
YT-14127	10.0	15.0	12	25	6/360
YT-14128	12.0	17.0	15	25	6/360
YT-14129	13.0	18.0	16	25	6/360

EN Extension bar
PL Przedłużka
DE Verlängerung
RU Удлинитель для воротка
CZ Prodlužovací přípravek
HU Toldalék
RO Prelungitor
FR Rallonge
IT Prolunga
ES Tubo de prolongación
CN 接杆

1/4"
6.3mm
DIN 3121
CrV 50BV30

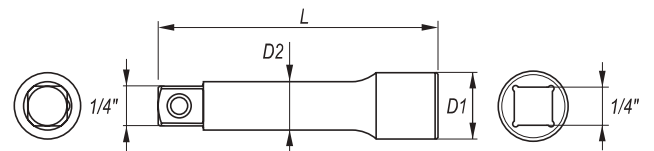

YATO	o	D1 [mm]	D2 [mm]	L [mm]	PCS POMIĘ	
YT-1429	1/4" (6.3 mm)	12.4	8.3	50.8	30	150/300
YT-1430	1/4" (6.3 mm)	12.4	8.3	76.0	30	150/300
YT-1431	1/4" (6.3 mm)	12.4	8.3	101.6	20	100/200
YT-1432	1/4" (6.3 mm)	12.4	8.3	152.4	20	100/200

EN Extension bar with wobble
 PL Przedłużka uchylna
 DE Gelenkverlängerung
 RU Удлинитель наклонный
 CZ Odchylný prodlužovací přípravek
 HU Csuklós toldtalék

RO Prelungitor rabatabil
 FR Rallonge angulaire
 IT Prolunga
 ES Tubo de prolongación desviable
 CN 转向接杆

1/4"
6.3mm
DIN 3121
CrV
50BV30

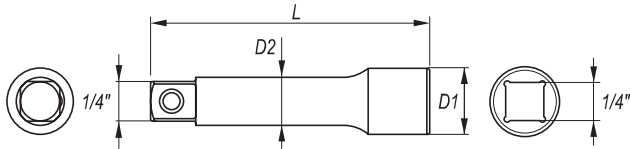

YATO	Ø	D1 [mm]	D2 [mm]	L [mm]	PCS PIECE	
YT-1433	1/4" (6.3 mm)	12.4	8.3	50.8	30	150/300
YT-1434	1/4" (6.3 mm)	12.4	8.3	76.0	30	150/300
YT-1435	1/4" (6.3 mm)	12.4	8.3	101.6	20	100/200
YT-1436	1/4" (6.3 mm)	12.4	8.3	152.4	20	100/200

EN Bit adapter
 PL Adapter do bitów
 DE Bithalter
 RU Держатель винтовёртовых наконечников
 CZ Držák na šroubovakové koncovky
 HU Szár a csavarhúzóvégekhez
 RO Capete şurubelniţă
 FR Adaptateur d'embouts
 IT Chiave esagonale a bussola
 ES Mandril para puntas
 CN 旋具头接头

1/4"
6.3mm
CrV
6140

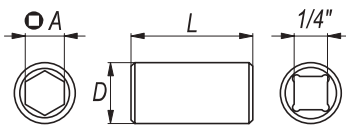

YATO	Ø	ØA	D [mm]	L [mm]	PCS PIECE	
YT-12971	1/4" (6.3 mm)	1/4" (6.3 mm)	11.8	24	5/600	

EN Universal joint
 PL Przegub Cardana
 DE Kardangelenk
 RU Карданный шарнир
 CZ Kardanový kloub
 HU Kardán csukló

RO Articulație Cardanică
 FR Cardan
 IT Snodo cardanico
 ES Articulación Cardan
 CN 万向接头

1/4"
6.3mm
DIN 3121
CrV
50BV30

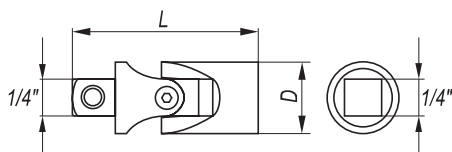

YATO	Ø	D [mm]	L [mm]	PCS PIECE	
YT-1437	1/4" (6.3 mm)	14	35	20	120/240

EN Adapter
 PL Redukcja
 DE Reduktion
 RU Переходник
 CZ Redukce
 HU Redukció

RO Reducție
 FR Réduction
 IT Riduttore
 ES Reducción
 CN 转换头

1/4"
6.3mm
DIN 3121
CrV
50BV30

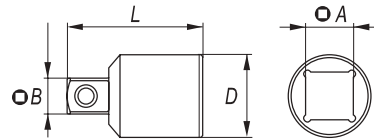
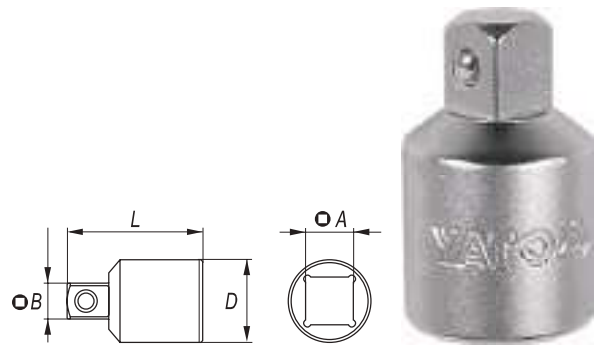

YATO	ØA	ØB	D [mm]	L [mm]	PCS PIECE	
YT-1438	1/4" (6.3 mm) (F)	3/8" (9.5 mm) (M)	12	25	10	250/500

EN Bit adapter
 PL Adapter do bitów
 DE Bithalter
 RU Держатель винтовёртовых наконечников
 CZ Držák na šroubovakové koncovky
 HU Szár a csavarhúzóvégekhez
 RO Capete şurubelniţă
 FR Adaptateur d'embouts
 IT Chiave esagonale a bussola
 ES Mandril para puntas
 CN 旋具头接头

1/4"
6.3mm
CrV
6140

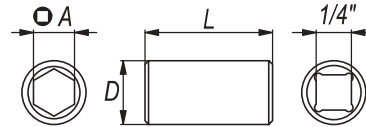

YATO	Ø	ØA	D [mm]	L [mm]	PCS PIECE	
YT-1297	1/4" (6.3 mm)	1/4" (6.3 mm)	11.8	24	10	250/1000

EN Spinner handle
 PL Pokrętko do nasadek
 DE Drehgriff für Steckschlüssel
 RU Ручка с соединением под головки
 CZ Nástrčná rukojeť
 HU Csavarhúzószáj hajtószár

RO Maner şurubelniţa cu antrenor
 FR Barre
 IT Porta bussola con manico
 ES Destornillador con cuadradillo
 CN 旋柄

1/4"
6.3mm
CrV
50BV30



YATO	Ø	L [mm]	PCS PIECE	
YT-1427	1/4" (6.3 mm)	150	12	48

EN Sliding T-bar
PL Pokrętko typu „T”
DE Handgriff mit Gleitstück
RU Вороток Т-образный
CZ Otočná ráčka typ „T”
HU „T” alakú hajtőkar

RO Măner clupă tipul „T”
FR Barre type „T”
IT Manopola „T” scorrevole
ES Mango tipo „T”
CN 滑杆

1/4"
6.3mm
DIN 3121
CrV 50BV30

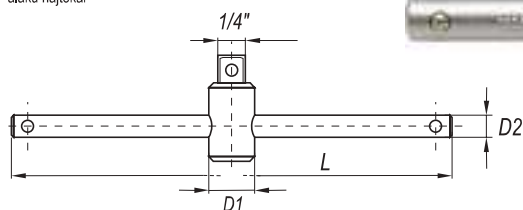

YATO	Ø	D1 [mm]	D2 [mm]	L [mm]	PCS ROZB	
YT-1426	1/4" (6.3 mm)	13.3	6.3	152.4	10	100/200

EN Flexible handle
PL Pokrętko lamane
DE Gelenkgriff
RU Вороток шарнирный
CZ Otočná lomená ráčka
HU Hajlított hajtőkar

RO Prelungitor cu prindere flexibilă
FR Barre pivotante
IT Manopola a snodo
ES Mango articulado
CN 转向手柄

1/4"
6.3mm
DIN 3121
CrV 50BV30

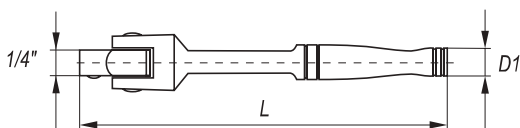

YATO	Ø	D [mm]	L [mm]	PCS ROZB	
YT-1425	1/4" (6.3 mm)	13	140	10	100/200

EN Quick release ratchet handle
PL Grzechotka
DE Hebelumschaltknarre
RU Трещотка

CZ Řehtačka
HU Racsnis hajtőkar
RO Dispozitiv de prindere cu clichet
FR Clé à cliquet

IT Cricchetto bussola
ES Carraca
CN 快速脱落棘轮扳手

1/4"
6.3mm
DIN 3122
QUICK RELEASE SZYBKO-ZŁĄCZE
72T



CrV 6140

YATO	Ø	T	L [mm]	PCS ROZB	
YT-0307	1/4" (6.3 mm)	72	146	12	24/96



CrV 6140

YATO	Ø	T	L [mm]	PCS ROZB	
YT-0310	1/4" (6.3 mm)	72	125	12	36/72



CrV 6140

YATO	Ø	T	L [mm]	PCS ROZB	
YT-0313	1/4" (6.3 mm)	72	125	12	24/96



CrV 6135

YATO	Ø	T	L [mm]	PCS ROZB	
YT-0316	1/4" (6.3 mm)	72	145	12	24/96



CrV 6140

YATO	Ø	T	L [mm]	PCS ROZB	
YT-0322	1/4" (6.3 mm)	72	148	12	48/96

EN Quick release ratchet handle
PL Grzechotka
DE Hebelumschaltknarre
RU Трещотка

CZ Ráčna
HU Racsnis hajtőkar
RO Dispozitiv de prindere cu clichet
FR Clé à cliquet

IT Cricchetto bussola
ES Carraca
CN 快速脱落棘轮扳手

1/4"
6.3mm
DIN 3122
QUICK RELEASE SZYBKO-ZŁĄCZE
72T
CrV 6140

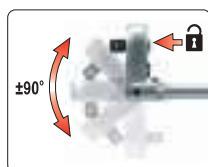





YATO	Ø	T	L [mm]	PCS ROZB	
YT-0325	1/4" (6.3 mm)	72	159	12	48/96

EN Quick release ratchet handle
 PL Grzechotka powlekana
 DE Hebelumschaltknarre
 RU Трещотка
 CZ Řehtačka
 HU Racsnis hajtókar
 RO Dispozitiv de prindere cu clichet
 FR Clé à cliquet
 IT Cricchetto bussola
 ES Carraca
 CN 快速脱落棘轮扳手

1/4"
6.3mm
DIN 3122
QUICK RELEASE SZYBKO-ZŁĄCZE
72T
CrV 6135 



YATO 	Ø	T	L [mm]	PCS <small>ROBIE</small>	
YT-0290	1/4" (6.3 mm)	72	144	12	48/96

YATO 	Ø	T	L [mm]	PCS <small>ROBIE</small>	
YT-0293	1/4" (6.3 mm)	72	144	12	48/96



EN Quick release ratchet handle
 PL Grzechotka
 DE Hebelumschaltknarre
 RU Трещотка
 CZ Ráčna
 HU Racsnis hajtókar
 RO Dispozitiv de prindere cu clichet
 FR Clé à cliquet
 IT Cricchetto bussola
 ES Carraca
 CN 快速脱落棘轮扳手



1/4"
6.3mm
QUICK RELEASE SZYBKO-ZŁĄCZE
72T
CrV 6140 

EN Quick release ratchet handle
 PL Grzechotka
 DE Hebelumschaltknarre
 RU Трещотка
 CZ Ráčna
 HU Racsnis hajtókar
 RO Dispozitiv de prindere cu clichet
 FR Clé à cliquet
 IT Cricchetto bussola
 ES Carraca
 CN 快速脱落棘轮扳手

1/4"
6.3mm
QUICK RELEASE SZYBKO-ZŁĄCZE
72T
CrV 6135 





YATO 	Ø	T	L [mm]	PCS <small>ROBIE</small>	
YT-0730	1/4" (6.3 mm)	72	155	12	12/96

YATO 	Ø	T	L [mm]	PCS <small>ROBIE</small>	
YT-0733	1/4" (6.3 mm)	72	155	12	24/96

EN Telescopic ratchet handle
 PL Grzechotka z przedłużanym uchwytem
 DE Umschaltknarre
 RU Трещотка
 CZ Ráčna
 HU Racsnis hajtókar
 RO Antrenor cu clichet
 FR Clé à cliquet
 IT Cricchetto bussola
 ES Carraca telescópico
 CN 可伸缩快速脱落棘轮扳手

1/4"
6.3mm
QUICK RELEASE SZYBKO-ZŁĄCZE
72T
CrV 6135 



YATO 	Ø	T	L [mm]	PCS <small>ROBIE</small>	
YT-0297	1/4" (6.3 mm)	72	150-200	12	12/48

EN Ratchet handle and bit drive
 PL Grzechotka do bitów i nasadek
 DE Bit- und Steckschlüssel-Umschaltknarre
 RU Трещотка для битов и головок
 CZ Ráčna kombinovaná pro bity a nástrčné kľíče
 HU Bit és dugófej behajtó racsnis hajtókar
 RO Antrenor cu clichet pt. biti
 FR Clé à cliquet
 IT Cricchetto bussola per punte e snodi
 ES Carraca para boquillas y puntas
 CN 套筒旋具两用棘轮扳手



1/4"
6.3mm
1/4"
6.3mm
DIN 3122
QUICK RELEASE SZYBKO-ZŁĄCZE
72T
CrV 6140 

EN Swivel ratchet handle for bits and sockets
 PL Grzechotka z obrotową głowicą do bitów i nasadek
 DE Drehkopfratsche für Bits und Steckschlüssel
 RU Трещотка для бит и головок с шарниром
 CZ Ráčna s otočnou hlavou na hlavice a bity
 HU Racsnis hajtószár bit és dugókulcshoz
 RO Antrenor clichet cu articulatie pentru tubulare și biți
 FR Cliquet à tête pivotante pour embouts et douilles
 IT Cricchetto con testa rotante per punte e chiavi a bussola
 ES Carraca con cabeza giratoria
 CN 套筒旋具两用棘轮扳手



1/4"
6.3mm
1/4"
6.3mm
DIN 3122
5°
3D
72T
CrV 6140 



YATO 	Ø	T	L [mm]	PCS <small>ROBIE</small>	
YT-0331	1/4" (6.3 mm) x 1/4" (6.3 mm)	72	136	12	48

YATO 	Ø	T	L [mm]	PCS <small>ROBIE</small>	
YT-03311	1/4" (6.3 mm) x 1/4" (6.3 mm)	72	115	10	10/100

EN Hexagonal socket
PL Nasadka sześciokątna
DE Sechskantenschlüssel
RU Головка шестигранная короткая
CZ Šestihřanný nástavec
HU Dugókulcs hatszög
RO Cheie tubulară hexagonală
FR Douille courte
IT Chiave a bussola esagonale
ES Boquilla hexagonal corta
CN 六角套筒

3/8"
9.5 mm

DIN
3121

CrV
50BV30

AS-DRIVE

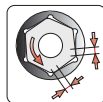
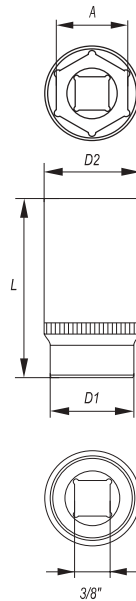

- Drive locks
- Surface finish: chromed, satin / mirror
- Zamki blokujące
- Wykończenie powierzchni: chromowana, satynowa / polerowana

YATO	o A [mm]	D1 [mm]	D2 [mm]	L [mm]	PCS PCSKB	
YT-3801	6	10	17	28	24	240/480
YT-3802	7	11	17	28	24	240/480
YT-3803	8	12	17	28	24	240/480
YT-3804	9	13	17	28	24	240/480
YT-3805	10	14	17	28	24	240/480
YT-3806	11	16	17	28	24	240/480
YT-3807	12	18	17	28	24	240/480
YT-3808	13	19	18	28	24	240/480
YT-3809	14	20	19	28	24	240/480
YT-3810	15	21	19	28	12	240/480
YT-3811	16	22	21	28	12	240/480
YT-3812	17	24	22	30	12	120/240
YT-3813	18	25	23	30	12	120/240
YT-3814	19	26	24	30	12	120/240

EN Extension bar
PL Przedłużka
DE Verlängerung
RU Удлинитель для воротка
CZ Prodlužovací přípravek
HU Toldalék
RO Prelungitor
FR Rallonge
IT Prolunga
ES Tubo de prolongación
CN 接杆

3/8"
9.5 mm

DIN
3121

CrV
50BV30

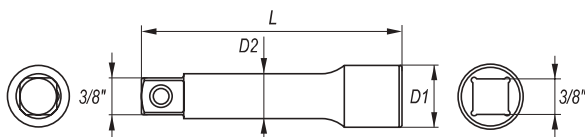

YATO	o	D1 [mm]	D2 [mm]	L [mm]	PCS PCSKB	
YT-3842	3/8" (9.5 mm)	18	12.3	42.0	10	100/200
YT-3843	3/8" (9.5 mm)	18	12.3	76.0	10	100/200
YT-3844	3/8" (9.5 mm)	18	12.3	152.4	10	50/100
YT-3845	3/8" (9.5 mm)	18	12.3	254.0	10	50

EN Hexagonal deep socket
PL Nasadka sześciokątna długa
DE Sechskantenschlüssel, lange
RU Головка шестигранная длинная
CZ Šestihřanný hluboký nástavec
HU Dugókulcs hatszög hosszú
RO Cheie tubulară hexagonală adâncă
FR Douille longue
IT Chiave a bussola esagonale
ES Boquilla hexagonal larga
CN 六角长套筒

3/8"
9.5 mm

DIN
3121

CrV
50BV30

AS-DRIVE

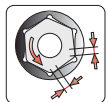
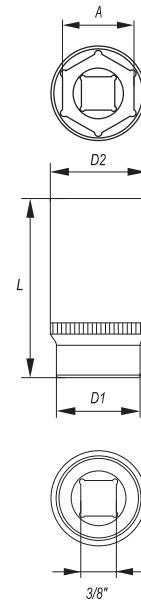

- Drive locks
- Surface finish: chromed, satin / mirror
- Zamki blokujące
- Wykończenie powierzchni: chromowana, satynowa / polerowana

YATO	o A [mm]	D1 [mm]	D2 [mm]	L [mm]	PCS PCSKB	
YT-3820	6	10	17	63	24	48/96
YT-3821	7	10	17	63	24	48/96
YT-3822	8	12	17	63	24	48/96
YT-3823	9	13	17	63	24	48/96
YT-3824	10	14	17	63	24	48/96
YT-3825	11	16	17	63	24	48/96
YT-3826	12	18	17	63	24	48/96
YT-3827	13	19	17	63	24	48/96
YT-3828	14	20	19	63	24	48/96
YT-3829	15	21	19	63	12	60/120
YT-3830	16	22	20	63	12	60/120
YT-3831	17	24	23	63	12	60/120
YT-3832	18	25	23	63	12	60/120
YT-3833	19	26	24	63	12	60/120

EN Extension bar with wobble
PL Przedłużka uchylna
DE Gelenkverlängerung
RU Удлинитель наклонный
CZ Odchylný prodlužovací přípravek
HU Csuklós toldalék

RO Prelungitor rabatabil
FR Rallonge angulaire
IT Prolunga
ES Tubo de prolongación desviable
CN 转向接杆

3/8"
9.5 mm

DIN
3121

CrV
50BV30

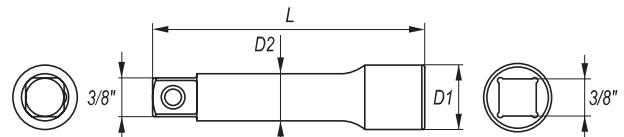

YATO	o	D1 [mm]	D2 [mm]	L [mm]	PCS PCSKB	
YT-3847	3/8" (9.5 mm)	18	12.3	76.0	10	100/200
YT-3848	3/8" (9.5 mm)	18	12.3	152.4	10	50/100
YT-3849	3/8" (9.5 mm)	18	12.3	254.0	10	50

EN Adapter
 PL Redukcja
 DE Reduktion
 RU Переходник
 CZ Redukce
 HU Redukció
 RO Reducție
 FR Réduction
 IT Riduttore
 ES Reducción
 CN 转换头

3/8"
9.5 mm **DIN 3121** **CrV 50BV30**

EN Bit adapter
 PL Adapter do bitów
 DE Bithalter
 RU Держатель винтовёртовых наконечников
 CZ Držák na šroubovakové koncovky
 HU Szár a csavarhúzóvégekhöz
 RO Capete şurubelniță
 FR Adapteur d'embouts
 IT Chiave esagonale a bussola
 ES Mandril para puntas
 CN 旋具头接头

3/8"
9.5 mm **CrV 6140**

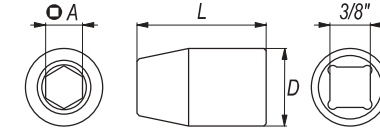

YATO	Ø	Ø A [mm]	D [mm]	L [mm]	PCS PCS/RE	
YT-12961	3/8" (9.5 mm)	8	17.9	30	5/300	

EN Universal joint
 PL Przegub Cardana
 DE Kardangelenk
 RU Карданный шарнир
 CZ Kardanový kloub
 HU Kardán csukló
 RO Articulație Cardanică
 FR Cardan
 IT Snodo cardanico
 ES Articulación Cardan
 CN 万向接头

3/8"
9.5 mm **DIN 3121** **CrV 50BV30**

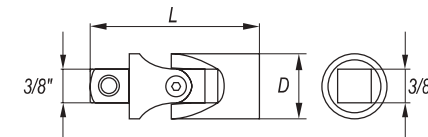

YATO	Ø	D [mm]	L [mm]	PCS PCS/RE	
YT-3850	3/8" (9.5 mm)	18	49	10	50/200

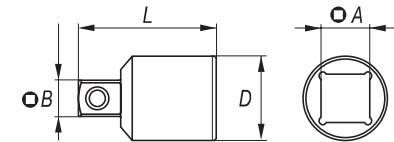

YATO	Ø A	Ø B	D [mm]	L [mm]	PCS PCS/RE	
YT-3853	3/8" (9.5 mm) (F)	1/4" (6.3 mm) (M)	17	27	10	250/500
YT-3854	3/8" (9.5 mm) (F)	1/4" (6.3 mm) (M)	17	35	10	100/200

EN Bit adapter
 PL Adapter do bitów
 DE Bithalter
 RU Держатель винтовёртовых наконечников
 CZ Držák na šroubovakové koncovky
 HU Szár a csavarhúzóvégekhöz
 RO Capete şurubelniță
 FR Adapteur d'embouts
 IT Chiave esagonale a bussola
 ES Mandril para puntas
 CN 旋具头接头

3/8"
9.5 mm **CrV 6140**

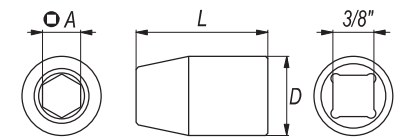

YATO	Ø	Ø A [mm]	D [mm]	L [mm]	PCS PCS/RE	
YT-1296	3/8" (9.5 mm)	8	17.9	30	10	250/500

EN Sliding T-bar
 PL Pokręto typu „T”
 DE Handgriff mit Gleitstück
 RU Вороток T-образный

CZ Otočná ráčká typ „T”
 HU „T” alakú hajítókar
 RO Mâner clupă tipul „T”
 FR Barre type „T”

IT Manopola „T” scorrevole
 ES Mango tipo „T”
 CN 滑行杆

3/8"
9.5 mm **CrV 50BV30** **DIN 3121**

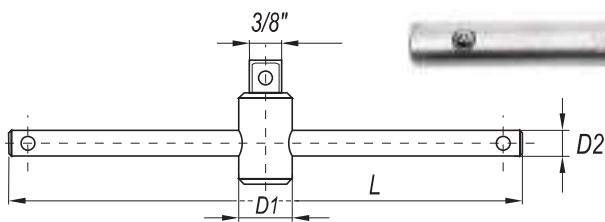

YATO	Ø	D1 [mm]	D2 [mm]	L [mm]	PCS PCS/RE	
YT-3840	3/8" (9.5 mm)	20	10.7	198	10	50/100

EN Flexible handle
 PL Pokręto lamane
 DE Gelenkgriff
 RU Вороток шарнирный

CZ Otočná lomená ráčka
 HU Dugókulcs hatszög hosszú
 RO Prelungitor cu prindere flexibilă
 FR Barre pivotante

IT Manopola a snodo
 ES Mango articulado
 CN 转向手柄

3/8"
9.5 mm **DIN 3121** **CrV 50BV30**

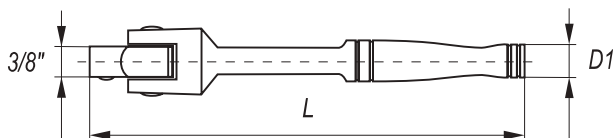

YATO	Ø	D [mm]	L [mm]	PCS PCS/RE	
YT-3839	3/8" (9.5 mm)	16	215	8	24/48

EN Quick release ratchet handle
PL Grzechotka
DE Hebelumschaltknarre
RU Трещотка
CZ Řehtačka
HU Racsnis hajtókar
RO Dispozitiv de prindere cu dchet
FR Clé à cliquet
IT Cricchetto bussola
ES Carraca
CN 快速脱落棘轮扳手

3/8" 9.5 mm
DIN 3122
QUICK RELEASE SZYBKO-ZŁĄCZE
72T
CrV 6140



YATO	Ø	T	L [mm]	PCS PER PKG	Box
YT-0308	3/8" (9.5 mm)	72	185	6	24/48



YATO	Ø	T	L [mm]	PCS PER PKG	Box
YT-0311	3/8" (9.5 mm)	72	200	6	18/36



YATO	Ø	T	L [mm]	PCS PER PKG	Box
YT-0314	3/8" (9.5 mm)	72	170	6	24/48



YATO	Ø	T	L [mm]	PCS PER PKG	Box
YT-0317	3/8" (9.5 mm)	72	200	6	24/48



YATO	Ø	T	L [mm]	PCS PER PKG	Box
YT-0323	3/8" (9.5 mm)	72	197	6	24/48

EN Quick release ratchet handle
PL Grzechotka
DE Hebelumschaltknarre
RU Трещотка
CZ Ráčna
HU Racsnis hajtókar
RO Dispozitiv de prindere cu dchet
FR Clé à cliquet
IT Cricchetto bussola
ES Carraca
CN 快速脱落棘轮扳手

3/8" 9.5 mm
QUICK RELEASE SZYBKO-ZŁĄCZE
DIN 3122
72T
CrV 6140

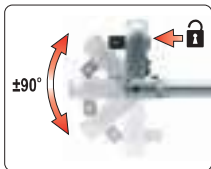

YATO	Ø	T	L [mm]	PCS PER PKG	Box
YT-0326	3/8" (9.5 mm)	72	242	6	24/48

EN Quick release ratchet handle
PL Grzechotka powlekana
DE Hebelumschaltknarre
RU Трещотка
HU Racsnis hajtókar
RO Dispozitiv de prindere cu dchet
FR Clé à cliquet
IT Cricchetto bussola
ES Carraca
CN 快速脱落棘轮扳手

3/8" 9.5 mm
DIN 3122
QUICK RELEASE SZYBKO-ZŁĄCZE
72T
CrV 6135



YATO	Ø	T	L [mm]	PCS PER PKG	Box
YT-0291	3/8" (9.5 mm)	72	202	6	24/48



YATO	Ø	T	L [mm]	PCS PER PKG	Box
YT-0294	3/8" (9.5 mm)	72	202	6	24/48

EN Quick release ratchet handle
PL Grzechotka
DE Hebelumschaltknarre
RU Трещотка
CZ Ráčna
HU Racsnis hajtókar
RO Dispozitiv de prindere cu dchet
FR Clé à cliquet
IT Cricchetto bussola
ES Carraca
CN 快速脱落棘轮扳手

3/8" 9.5 mm
QUICK RELEASE SZYBKO-ZŁĄCZE
72T
CrV 6140

EN Telescopic ratchet handle
PL Grzechotka z przedłużanym uchwytem
DE Umschaltknarre
RU Трещотка
CZ Ráčna
HU Racsnis hajtókar
RO Antrenor cu dchet
FR Clé à cliquet
IT Cricchetto bussola
ES Carraca telescópico
CN 可伸缩快速脱落棘轮扳手



3/8" 9.5 mm
QUICK RELEASE SZYBKO-ZŁĄCZE
72T
CrV 6135



YATO	Ø	T	L [mm]	PCS PER PKG	Box
YT-0731	3/8" (9.5 mm)	72	200	6	6/48



YATO	Ø	T	L [mm]	PCS PER PKG	Box
YT-0298	3/8" (9.5 mm)	72	215-315	6	6/24

- EN Hexagonal socket
- PL Nasadka sześciokątna
- DE Sechskantenschlüssel
- RU Головка шестигранная короткая
- CZ Šestihranný nástavec
- HU Dugókulcs hatszög
- RO Cheie tubulară hexagonală
- FR Douille courte
- IT Chiave a bussola esagonale
- ES Boquilla hexagonal corta
- CN 六角套筒

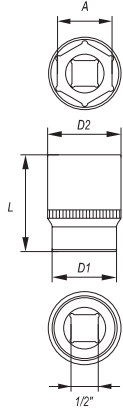

1/2"
12.7mm

DIN
3121

CrV
50BV30

AS-DRIVE

- Drive locks
- Surface finish: chromed, satin / mirror
- Zamki blokujące
- Wykończenie powierzchni: chromowana, satynowa / polerowana

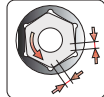

YATO	o A [mm]	D1 [mm]	D2 [mm]	L [mm]	PCS PIECE	
YT-1201	8	12	22	38	12	120/240
YT-1202	9	14	22	38	12	120/240
YT-1203	10	15	22	38	12	120/240
YT-1204	11	16	22	38	12	120/240
YT-1205	12	18	22	38	12	120/240
YT-1206	13	19	22	38	12	120/240
YT-1207	14	20	22	38	12	120/240
YT-1208	15	21	22	38	12	120/240
YT-1209	16	23	22	38	12	120/240
YT-1210	17	24	23	38	12	120/240
YT-1211	18	25	23	38	12	120/240
YT-1212	19	27	24	38	12	120/240
YT-1213	20	28	24	38	12	120/240
YT-1214	21	29	24	38	12	120/240
YT-1215	22	30	26	38	12	120/240
YT-1216	23	31	28	38	12	60/120
YT-1217	24	32	28	38	12	60/120
YT-1218	27	36	30	42	12	60/120
YT-1219	30	40	34	42	12	60/120
YT-1220	32	42	36	42	6	24/48

- EN Bi-hexagonal socket
- PL Nasadka dwunastokątna
- DE Zwölfkant-Steckschlüssel-Einsatz
- RU Головка 12-гранная
- CZ Nástrčný ořech dvanáctihřanný
- HU Dugókulcs 12-szögű
- RO Cheie tubulară bihexagonală
- FR Douille courte
- IT Chiave a bussola bi-esagonale
- ES Boquilla de anillo
- CN 十二角套筒

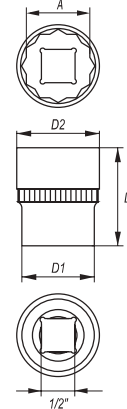

1/2"
12.7mm

DIN
3121

CrV
50BV30

AS-DRIVE

- Drive locks
- Surface finish: chromed, satin / mirror
- Zamki blokujące
- Wykończenie powierzchni: chromowana, satynowa / polerowana

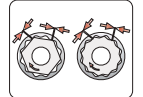

YATO	o A [mm]	D1 [mm]	D2 [mm]	L [mm]	PCS PIECE	
YT-1270	8	12	22	38	12	120/240
YT-1271	9	14	22	38	12	120/240
YT-1272	10	15	22	38	12	120/240
YT-1273	11	16	22	38	12	120/240
YT-1274	12	17	22	38	12	120/240
YT-1275	13	19	22	38	12	120/240
YT-1276	14	20	22	38	12	120/240
YT-1277	15	21	22	38	12	120/240
YT-1278	16	23	22	38	12	120/240
YT-1279	17	24	22	38	12	120/240
YT-1280	18	25	23	38	12	120/240
YT-1281	19	27	24	38	12	120/240
YT-1282	20	28	24	38	12	120/240
YT-1283	21	29	24	38	12	120/240
YT-1284	22	30	26	38	12	120/240
YT-1285	23	31	28	38	12	60/120
YT-1286	24	32	28	38	12	60/120
YT-1289	27	36	30	42	12	60/120
YT-1291	30	40	34	42	6	48/96
YT-1292	32	42	36	42	6	48/96

- EN Spline socket
- PL Nasadka Spline
- DE Steckschlüssel Spline
- RU Головка Spline
- CZ Nástrčný klíč profil Spline
- HU Dugókulcs Spline
- RO Cheie tubulară cu stifturi
- FR Douille
- IT Chiave a bussola Spline
- ES Boquilla Spline
- CN 花键型套筒

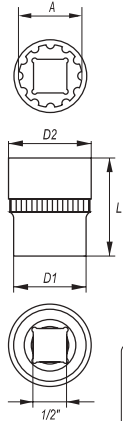

1/2"
12.7mm

DIN
3121

CrV
50BV30

- Drive locks
- Enables to undo 5 types of screws
- Surface finish: chromed, satin / mirror
- Zamki blokujące
- Możliwość odkręcenia 5 rodzajów śrub
- Wykończenie powierzchni: chromowana, satynowa / polerowana



YATO	o A [mm]	D1 [mm]	D2 [mm]	L [mm]	PCS PIECE	
YT-1460	8	13	22	38	12	120/240
YT-1461	9	15	22	38	12	120/240
YT-1462	10	16	22	38	12	120/240
YT-1463	11	17	22	38	12	120/240
YT-1464	12	18	22	38	12	120/240
YT-1465	13	19	22	38	12	120/240
YT-1466	14	20	22	38	12	120/240
YT-1467	15	22	23	38	12	120/240
YT-1468	16	23	22	38	12	120/240
YT-1469	17	25	23	38	12	120/240
YT-1470	18	26	23	38	12	120/240
YT-1471	19	27	24	38	12	120/240
YT-1472	20	28	24	38	12	120/240
YT-1473	21	30	24	38	12	120/240
YT-1474	22	31	26	38	12	120/240
YT-1475	23	32	28	38	12	60/120
YT-1476	24	34	28	38	12	60/120
YT-1478	27	37	30	42	12	60/120
YT-1480	30	41	34	42	6	60/120
YT-1481	32	44	36	42	6	60/120

- EN Spline socket
- PL Nasadka Spline
- DE Steckschlüssel Spline
- RU Головка Spline
- CZ Nástrčný klíč profil Spline
- HU Dugókulcs Spline
- RO Cheie tubulară cu stifturi
- FR Douille
- IT Chiave a bussola Spline
- ES Boquilla Spline
- CN 花键型套筒

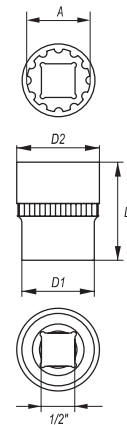

1/2"
12.7mm

CrV
50BV30

- Drive locks
- Enables to undo 5 types of screws
- Surface finish: chromed, satin / mirror
- Zamki blokujące
- Możliwość odkręcenia 5 rodzajów śrub
- Wykończenie powierzchni: chromowana, satynowa / polerowana

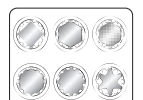

YATO	o A [mm]	D1 [mm]	D2 [mm]	L [mm]	PCS PIECE	
YT-14820	8	13	22	38	10/200	
YT-14821	9	15	22	38	10/200	
YT-14822	10	16	22	38	10/200	
YT-14824	12	18	22	38	10/200	
YT-14825	13	19	22	38	10/200	
YT-14826	14	20	22	38	10/200	
YT-14827	15	22	22	38	10/200	
YT-14828	16	23	22	38	10/200	
YT-14829	17	25	23	38	10/200	
YT-14830	18	26	23	38	10/200	
YT-14831	19	27	24	38	10/200	
YT-14833	21	30	24	38	10/160	
YT-14834	22	31	26	38	10/160	
YT-14836	24	34	28	38	10/160	
YT-14838	30	41	34	42	5/60	
YT-14839	32	44	36	45	5/60	

EN Hexagonal deep socket
PL Nasadka sześciokątna długa
DE Sechskantenschlüssel, lange
RU Головка шестигранная длинная
CZ Šestihranný hluboký nástavec
HU Dugókulcs hatszög hosszú
RO Cheie tubulară hexagonală adâncă
FR Douille longue
IT Chiave a bussola esagonale
ES Boquilla hexagonal larga
CN 六角长套筒

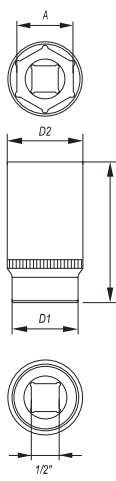

1/2"
12.7mm

DIN
3121

CrV
50BV30

AS-DRIVE



• Drive locks
• Surface finish: chromed, satin / mirror

• Zamki blokujące
• Wykończenie powierzchni: chromowana, satynowa / polerowana

YATO	o A [mm]	D1 [mm]	D2 [mm]	L [mm]	PCS ROCK	
YT-1221	8	13	22	76	12	60/120
YT-1222	9	14	22	76	12	60/120
YT-1223	10	15	22	76	12	60/120
YT-1224	11	17	22	76	12	60/120
YT-1225	12	18	22	76	12	60/120
YT-1226	13	19	22	76	12	60/120
YT-1227	14	20	22	76	12	60/120
YT-1228	15	21	22	76	12	60/120
YT-1229	16	24	22	76	12	60/120
YT-1230	17	24	22	76	12	60/120
YT-1231	18	25	23	76	12	60/120
YT-1232	19	27	24	76	12	60/120
YT-1233	20	28	24	76	12	60/120
YT-1234	21	29	24	76	12	60/120
YT-1235	22	30	26	76	12	60/120
YT-1236	23	31	28	76	12	60/120
YT-1237	24	32	28	76	12	60/120
YT-1238	27	36	30	76	12	36/72
YT-1239	30	40	36	76	12	24/48
YT-1240	32	42	38	76	6	24/48

EN Bi-hexagonal deep socket
PL Nasadka dwunastokątna długa
DE Zwölfkant-Steckschlüssel-Einsatz, lange
RU Головка 12-гранная длинная
CZ Dvanáctihřanný hluboký nástavec
HU Dugókulcs 12-szög hosszú
RO Cheie tubulară bihexagonală adâncă
FR Douille longue
IT Chiave a bussola bi-esagonale
ES Boquilla de anillo larga
CN 十二角长套筒

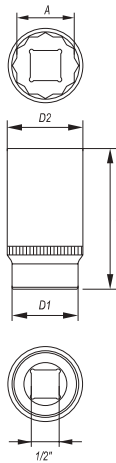

1/2"
12.7mm

DIN
3121

CrV
50BV30

AS-DRIVE



YATO	o A [mm]	D1 [mm]	D2 [mm]	L [mm]	PCS ROCK	
YT-12930	8	22	14	77	12	60/120
YT-12931	9	22	16	77	12	60/120
YT-12932	10	22	16	77	12	60/120
YT-12933	11	22	18	77	12	60/120
YT-12934	12	22	18	77	12	60/120
YT-12935	13	22	19	77	12	60/120
YT-12936	14	22	19	77	12	60/120
YT-12937	15	21	22	77	12	60/120
YT-12938	16	21	22	77	12	60/120
YT-12939	17	22	24	77	12	60/120
YT-12940	18	22	26	77	12	60/120
YT-12941	19	22	26	77	12	60/120
YT-12942	20	24	28	77	12	60/120
YT-12943	21	24	28	77	12	60/120
YT-12944	22	26	30	77	12	60/120
YT-12945	23	27	32	77	12	60/120
YT-12946	24	28	32	77	12	60/120
YT-12947	27	30	36	77	12	36/72
YT-12948	30	34	40	77	6	24/48
YT-12949	32	36	42	77	6	24/48

EN Extension bar
PL Przedłużka
DE Verlängerung
RU Удлинитель для воротка
CZ Prodlužovací přípravek
HU Toldalék

RO Prelungitor
FR Rallonge
IT Prolunga
ES Tubo de prolongación
CN 接杆

1/2"
12.7mm

DIN
3121

CrV
50BV30

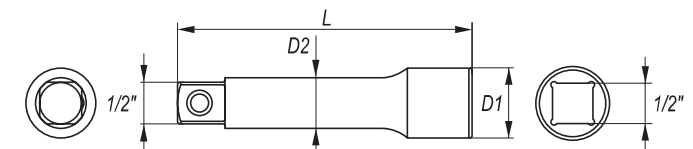

YATO	o	D1 [mm]	D2 [mm]	L [mm]	PCS ROCK	
YT-1246	1/2" (12.7 mm)	24	14.5	76	15	30/120
YT-1247	1/2" (12.7 mm)	24	14.5	127	5	20/80
YT-1248	1/2" (12.7 mm)	24	14.5	254	5	20/40

EN Extension bar with wobble
PL Przedłużka uchylna
DE Gelenkverlängerung
RU Удлинитель наклонный
CZ Odchylný prodlužovací přípravek
HU Csuklós toldalék

RO Prelungitor rabatabil
FR Rallonge angulaire
IT Prolunga
ES Tubo de prolongación desviado
CN 转向接杆

1/2"
12.7mm

DIN
3121

CrV
50BV30

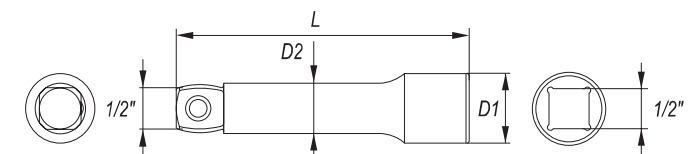

YATO	o	D1 [mm]	D2 [mm]	L [mm]	PCS ROCK	
YT-1249	1/2" (12.7 mm)	24	14.5	76	15	30/120
YT-1250	1/2" (12.7 mm)	24	14.5	127	5	20/80
YT-1251	1/2" (12.7 mm)	24	14.5	254	5	20/40

EN Adapter
PL Redukcja
DE Reduktion
RU Переходник
HU Redukció
RO Reducție
FR Réduction
IT Riduttore
ES Reducción
CN 转换头

1/2"
12.7mm

3/4"
19mm

DIN
3121

CrV
50BV30

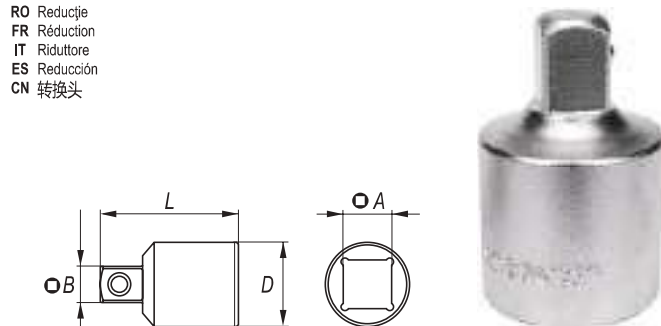

YATO	o A	o B	D [mm]	L [mm]	PCS ROCK	
YT-1255	1/2" (12.7 mm) (F)	3/8" (9.5 mm) (M)	22	34.0	10	100/200
YT-1258	1/2" (12.7 mm) (F)	3/4" (19.0 mm) (M)	27	45.5	10	50/100
YT-1259	3/4" (19.0 mm) (F)	1/2" (12.7 mm) (M)	35	51.0	5	50/100
YT-1356	1/2" (12.7 mm) (F)	3/4" (19.0 mm) (M)	26	48.0	12	48

- EN Bit adapter
- PL Adapter do bitów
- DE Bithalter
- RU Держатель винтовёртовых наконечников
- CZ Držák na šroubovakové koncovky
- HU Szár a csavarhúzóvégkeghez
- RO Capete şurubelniţă
- FR Adaptateur d'embouts
- IT Chiave esagonale a bussola
- ES Mandril para puntas
- CN 旋具头接头

1/2"
12.7mm

CrV
6140

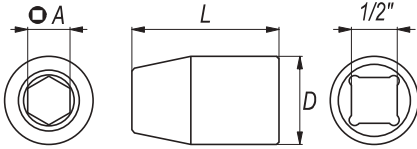

YATO	Ø	Ø A [mm]	D [mm]	L [mm]	
YT-12951	1/2" (12.7 mm)	8	21.9	38	5/300

- EN Bit adapter
- PL Adapter do bitów
- DE Bithalter
- RU Держатель винтовёртовых наконечников
- CZ Držák na šroubovakové koncovky
- HU Szár a csavarhúzóvégkeghez
- RO Capete şurubelniţă
- FR Adaptateur d'embouts
- IT Chiave esagonale a bussola
- ES Mandril para puntas
- CN 旋具头接头

1/2"
12.7mm

CrV
6140

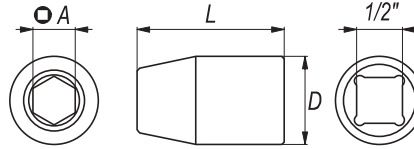

YATO	Ø	Ø A [mm]	D [mm]	L [mm]	PCS PIECE	
YT-1295	1/2" (12.7 mm)	8	21.9	38	10	150/300

- EN Universal joint
- PL Przegub Cardana
- DE Kardangelenk
- RU Карданный шарнир
- CZ Kardanový kloub
- HU Kardán csukló
- RO Articulaţie Cardanică
- FR Cardan
- IT Snodo cardanico
- ES Articulación Cardan
- CN 万向接头



1/2"
12.7mm

DIN
3121

CrV
50BV30

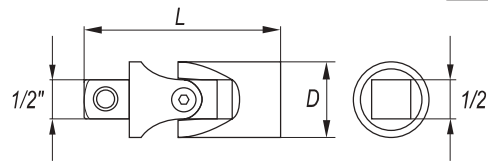

YATO	Ø	D [mm]	L [mm]	PCS PIECE	
YT-1252	1/2" (12.7 mm)	25	69	5	50/100

- EN Sliding T-bar
- PL Pokrętko typu „T”
- DE Handgriff mit Gleitstück
- RU Вороток Т-образный
- CZ Otočná ráčká typ „T”
- HU „T” alakú hajtókar
- RO Măner clupă tipul „T”
- FR Barre type „T”
- IT Manopola „T” scorrevole
- ES Mango tipo „T”
- CN 滑行杆

1/2"
12.7mm

DIN
3121

CrV
50BV30

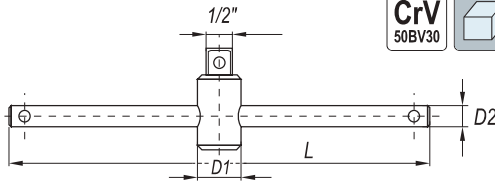

YATO	Ø	D1 [mm]	D2 [mm]	L [mm]	PCS PIECE	
YT-1243	1/2" (12.7 mm)	24	13.5	255	4	24/48

- EN Flexible handle
- PL Pokrętko lamane
- DE Gelenkgriff
- RU Вороток шарнирный
- CZ Otočná lomená ráčká
- HU Hajlított hajtókar
- RO Prelungitor cu prindere flexibilă
- FR Barre pivotante
- IT Manopola a snodo
- ES Mango articulado
- CN 转向手柄

1/2"
12.7mm

DIN
3121

CrV
50BV30

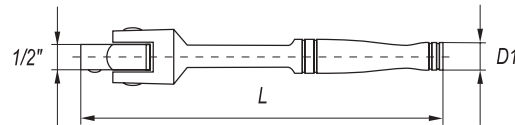

YATO	Ø	D [mm]	L [mm]	PCS PIECE	
YT-1241	1/2" (12.7 mm)	19	360	5	15/30
YT-1242	1/2" (12.7 mm)	20	457	5	10/20

- EN L-type handle
- PL Pokrętko typu „L”
- DE Admutterenschlüssel
- RU Вороток тип „L”
- CZ Páka zahnutá
- HU „L” alakú hajtókar
- RO Măner clupă tipul „L”
- FR Barre type „L”
- IT Leva tipo „L”
- ES Mango tipo „L”
- CN L型套筒扳手

1/2"
12.7mm

DIN
3121

CrV
50BV30

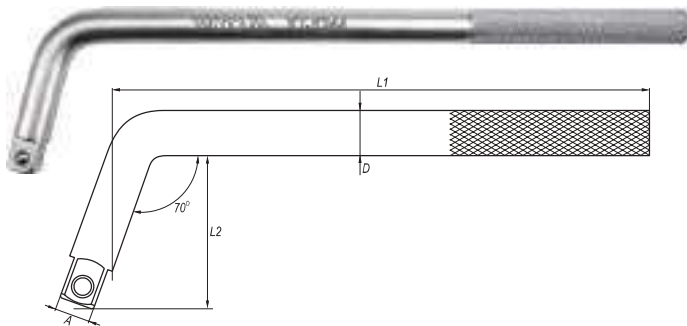

YATO	Ø	D [mm]	L1 [mm]	L2 [mm]	PCS PIECE	
YT-1244	1/2" (12.7 mm)	16	330	62	3	36

- EN L-type handle
- PL Pokrętko typu „L”
- DE Admutterenschlüssel
- RU Вороток тип „L”
- CZ Páka zahnutá
- HU „L” alakú hajtókar
- RO Măner clupă tipul „L”
- FR Barre type „L”
- IT Leva tipo „L”
- ES Mango tipo „L”
- CN L型扳手

1/2"
12.7mm

DIN
3122

CrV
50BV30

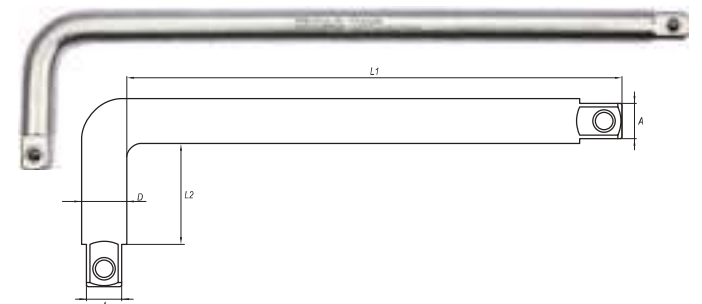

YATO	Ø	D [mm]	L1 [mm]	L2 [mm]	PCS PIECE	
YT-12439	1/2" (12.7 mm)	16	282	55	10	20
YT-12445	1/2" (12.7 mm)	16	585	190	4	4/12

EN Quick release ratchet handle
PL Grzechotka
DE Hebelumschaltknarre
RU Трещотка
CZ Řehtačka
HU Racsnis hajtókar

RO Dispozitiv de prindere cu dchet
FR Clé à cliquet
IT Cricchetto bussola
ES Carraca
CN 快速脱落棘轮扳手

1/2"
12.7mm
DIN
3122
72T
CrV
6140



YATO	Ø	T	L [mm]	PCS PKING	☐
YT-0309	1/2" (12.7 mm)	72	278	6	24



YATO	Ø	T	L [mm]	PCS PKING	☐
YT-0312	1/2" (12.7 mm)	72	250	6	12/24



YATO	Ø	T	L [mm]	PCS PKING	☐
YT-0315	1/2" (12.7 mm)	72	250	6	24



YATO	Ø	T	L [mm]	PCS PKING	☐
YT-0318	1/2" (12.7 mm)	72	250	6	24



YATO	Ø	T	L [mm]	PCS PKING	☐
YT-0324	1/2" (12.7 mm)	72	265	6	24

EN Quick release ratchet handle
PL Grzechotka
DE Hebelumschaltknarre
RU Трещотка
CZ Ráčna
HU Racsnis hajtókar

RO Dispozitiv de prindere cu dchet
FR Clé à cliquet
IT Cricchetto bussola
ES Carraca
CN 快速脱落棘轮扳手

1/2"
12.7mm
QUICK
RELEASE
SZYBKO-
ZŁĄCZE
72T
CrV
6140



YATO	Ø	T	L [mm]	PCS PKING	☐
YT-0732	1/2" (12.7 mm)	72	255	6	24

EN Telescopic ratchet handle
PL Grzechotka z przedłużanym uchwytem
DE Umschaltknarre
RU Трещотка

CZ Ráčna
HU Racsnis hajtókar
RO Antrenor cu clichet
FR Clé à cliquet

IT Cricchetto bussola
ES Carraca telescópico
CN 可伸缩快速脱落棘轮扳手



YATO	Ø	T	L [mm]	PCS PKING	☐
YT-0299	1/2" (12.7 mm)	72	305-445	6	24

EN Quick release ratchet handle
PL Grzechotka
DE Hebelumschaltknarre
RU Трещотка
CZ Ráčna
HU Racsnis hajtókar
RO Dispozitiv de prindere cu dchet
FR Clé à cliquet
IT Cricchetto bussola
ES Carraca
CN 快速脱落棘轮扳手

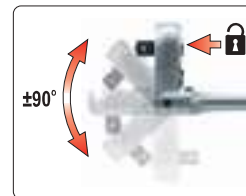

1/2"
12.7mm
QUICK
RELEASE
SZYBKO-
ZŁĄCZE
DIN
3122
72T
CrV
6140



YATO	Ø	T	L [mm]	PCS PKING	☐
YT-0327	1/2" (12.7 mm)	72	290	6	1/24

EN Quick release ratchet handle
PL Grzechotka powlekana
DE Hebelumschaltknarre
RU Трещотка
CZ Řehtačka
HU Racsnis hajtókar

RO Dispozitiv de prindere cu dchet
FR Clé à cliquet
IT Cricchetto bussola
ES Carraca
CN 快速脱落棘轮扳手

1/2"
12.7mm
DIN
3122
QUICK
RELEASE
SZYBKO-
ZŁĄCZE
72T
CrV
6135



YATO	Ø	T	L [mm]	PCS PKING	☐
YT-0292	1/2" (12.7 mm)	72	257	6	24



YATO	Ø	T	L [mm]	PCS PKING	☐
YT-0295	1/2" (12.7 mm)	72	257	6	24

EN Quick release ratchet handle
PL Grzechotka
DE Hebelumschaltknarre
RU Трещотка
CZ Ráčna
HU Racsnis hajtókar

RO Dispozitiv de prindere cu dchet
FR Clé à cliquet
IT Cricchetto bussola
ES Carraca
CN 快速脱落棘轮扳手

1/2"
12.7mm
QUICK
RELEASE
SZYBKO-
ZŁĄCZE
72T
CrV
6135





YATO	Ø	T	L [mm]	PCS PKING	☐
YT-0735	1/2" (12.7 mm)	72	255	6	24

EN Deep socket set
 PL Zestaw nasadek dlugich
 DE Lange Steckschlusselfsatz
 RU Набор высоких головок
 CZ Sada hlubokých nástavců
 HU Hosszú dugókulcs készlet
 RO Set tubulare
 FR Jeu de douilles longues
 IT Set di chiavi a bussola lunghe
 ES Juego de vasos largos
 CN 套筒组套

8 PCS **1/4"** 6.3mm **CrV** 50BV30 **AS-DRIVE** 









 1/4" (6.3 mm): 5.5, 6, 7, 8, 9, 10, 12, 13 mm (L=50 mm); CrV 50BV30

YATO 		
YT-14431	1/4" (6.3 mm)	10/20

EN Tool set
 PL Zestaw narzędziowy
 DE Werkzeug-Satz
 RU Набор инструмента
 CZ Sada nářadí
 HU Szerszámkészlet
 RO Trusa de scule
 FR Jeu d'outils
 IT Set di utensili
 ES Juego de herramientas
 CN 工具组套

23 PCS **1/4"** 6.3mm **CrV** 50BV30 **CrMo** 440
72T **AS-DRIVE** 









 1/4" (6.3 mm): 4, 5, 6, 7, 8, 9, 10, 12, 13 mm (L=25 mm); CrV 50BV30;
 1/4" (6.3 mm): 4, 5, 6, 7, 8, 9, 10, 12, 13 mm (L=50 mm); CrV 50BV30;
 1/4" (6.3 mm): (50.8, 152.4 mm); CrV 50BV30;
 1/4" (6.3 mm); CrV 50BV30;
 1/4" (6.3 mm); (155 mm); 72T; CrMo 440;
 1/4" (6.3 mm); (150 mm); CrV 50BV30



YATO 		
YT-14451	1/4" (6.3 mm)	10

EN Tool set
 PL Zestaw narzędziowy
 DE Werkzeug-Satz
 RU Набор инструмента
 CZ Sada nářadí
 HU Szerszámkészlet
 RO Trusa de scule
 FR Jeu d'outils
 IT Set di utensili
 ES Juego de herramientas
 CN 工具组套

20 PCS **1/4"** 6.3mm **CrV** 50BV30 **CrMo** 440
72T **AS-DRIVE** 









 1/4" (6.3 mm): 3.5, 4, 4.5, 5, 5.5, 6, 7, 8, 9, 10, 11, 12, 13, 14 mm (L=25 mm); CrV 50BV30;
 1/4" (6.3 mm); (51.6, 151.5 mm); CrV 50BV30;
 1/4" (6.3 mm); CrV 50BV30;
 1/4" (6.3 mm); (152.8 mm); CrV 50BV30;
 1/4" (6.3 mm); (155 mm); 72T; CrMo 440;
 1/4" (6.3 mm); (150 mm); CrV 50BV30



YATO 		
YT-14491	1/4" (6.3 mm)	10

EN Tool set
 PL Zestaw narzędziowy
 DE Werkzeug-Satz
 RU Набор инструмента
 CZ Sada nářadí
 HU Szerszámkészlet
 RO Trusa de scule
 FR Jeu d'outils
 IT Set di utensili
 ES Juego de herramientas
 CN 工具组套

25 PCS **1/4"** 6.3mm **CrV** 50BV30 **CrMo** 440
CrV 40 **72T** **AS-DRIVE** 



 1/4" (6.3 mm): 3.5, 4, 4.5, 5, 5.5, 6, 7, 8, 9, 10, 11, 12, 13, 14 mm (L=25 mm); CrV 50BV30;
 1/4" (6.3 mm): 8, 10, 11, 12, 13 mm (L=50 mm); CrV 50BV30;
 1/4" (6.3 mm); (50.8, 101.6 mm); CrV 50BV30;
 1/4" (6.3 mm); CrV 50BV30;
 1/4" (6.3 mm); (152.4 mm); CrV 40;
 1/4" (6.3 mm); (155 mm); 72T; CrMo 440;
 1/4" (6.3 mm); (150 mm); CrV 50BV30

YATO 		
YT-14461	1/4" (6.3 mm)	10











EN Tool set
PL Zestaw narzędziowy
DE Werkzeug-Satz
RU Набор инструмента



CZ Sada nářadí
HU Szerszámkészlet
RO Trusa de scule
FR Jeu d'outils

IT Set di utensili
ES Juego de herramientas
CN 工具组套

38 PCS	1/4" 6,3mm	CrV 50BV30	CrV 6150	CrV 40
CrMo 440	S2	72T	AS-DRIVE	



-  1/4" (6.3 mm): 3.5, 4, 4.5, 5, 5.5, 6, 7, 8, 9, 10, 11, 12, 13, 14 mm (L=25 mm); CrV 50BV30;
-  1/4" (6.3 mm): (50.8, 101.6 mm); CrV 50BV30;
-  1/4" (6.3 mm): CrV 50BV30;
-  1/4" (6.3 mm): (152.4 mm); CrV 40;
-  1/4" (6.3 mm): (155 mm); 72T; CrMo 440;
-  1/4" (6.3 mm): (150 mm); CrV 50BV30;
-  1/4" (6.3 mm): 4, 5.5, 6.5 mm (L=37 mm); AISI S2 / CrV 6150;
-  1/4" (6.3 mm): PH1, PH2 (L=37 mm); AISI S2 / CrV 6150;
-  1/4" (6.3 mm): PZ1, PZ2 (L=37 mm); AISI S2 / CrV 6150;
-  1/4" (6.3 mm): T10, T15, T20, T25, T30, T40 (L=37 mm); AISI S2 / CrV 6150;
-  1/4" (6.3 mm): 3, 4, 5, 6, 8 mm (L=37 mm); AISI S2 / CrV 6150

YATO 	○	
YT-14471	1/4" (6.3 mm)	10

EN Tool set
PL Zestaw narzędziowy
DE Werkzeug-Satz















RU Набор инструмента
CZ Sada nářadí
HU Szerszámkészlet



RO Trusa de scule
FR Jeu d'outils
IT Set di utensili

ES Juego de herramientas
CN 工具组套

56 PCS	1/4" 6,3mm	CrV 50BV30	CrV 6150	CrV 40
CrMo 440	S2	72T	AS-DRIVE	



-  1/4" (6.3 mm): 4, 4.5, 5, 5.5, 6, 7, 8, 9, 10, 11, 12, 13 mm (L=25 mm); CrV 50BV30;
-  1/4" (6.3 mm): 6, 7, 8, 9, 10, 11, 12, 13 mm (L=50 mm); CrV 50BV30;
-  1/4" (6.3 mm): E4, E5, E6, E7, E8, E10; CrV 6150;
-  1/4" (6.3 mm): (76, 152.4 mm); CrV 50BV30;
-  1/4" (6.3 mm): (150 mm); CrV 50BV30;
-  1/4" (6.3 mm); CrV 50BV30;
-  1/4" (6.3 mm): (152.4 mm); CrV 40;
-  1/4" (6.3 mm): (155 mm); 72T; CrMo 440;
-  1/4" (6.3 mm): (150 mm); CrV 50BV30;
-  1/4" (6.3 mm) (F) x 3/8" (9.5 mm) (M); CrV 50BV30;
-  1/4" (6.3 mm): 4, 5.5, 6.5 mm (L=37 mm); AISI S2 / CrV 6150;
-  1/4" (6.3 mm): PH1, PH2, PH3 (L=37 mm); AISI S2 / CrV 6150;
-  1/4" (6.3 mm): PZ1, PZ2, PZ3 (L=37 mm); AISI S2 / CrV 6150;
-  1/4" (6.3 mm): T8, T10, T15, T20, T25, T30, T40 (L=37 mm); AISI S2 / CrV 6150;
-  1/4" (6.3 mm): 3, 4, 5, 6, 7, 8 mm (L=37 mm); AISI S2 / CrV 6150

YATO 	○	
YT-14501	1/4" (6.3 mm)	10

EN Tool set
PL Zestaw narzędziowy
DE Werkzeug-Satz





RU Набор инструмента
CZ Sada nářadí
HU Szerszámkészlet

RO Trusa de scule
FR Jeu d'outils
IT Set di utensili

ES Juego de herramientas
CN 工具组套

22 PCS	3/8" 9,5mm	CrV 50BV30	CrV 40
CrMo 440	72T	AS-DRIVE	



-  3/8" (9.5 mm): 6, 7, 8, 9, 10, 11, 12, 13, 14, 15, 16 mm (L=28 mm); 17, 18, 19, 20, 21, 22 mm (L=30 mm); CrV 50BV30;
-  3/8" (9.5 mm): (76, 152.4 mm); CrV 50BV30;
-  3/8" (9.5 mm): CrV 50BV30;
-  3/8" (9.5 mm): (198 mm); CrV 40;
-  3/8" (9.5 mm): (200 mm); 72T; CrMo 440



YATO 	○	
YT-38561	3/8" (9.5 mm)	10

EN Deep socket set
 PL Zestaw nasadek dlugich
 DE Lange Steckschlüsselsatz
 RU Набор высоких головок
 CZ Sada hlubokých nástavců
 HU Hosszú dugókulcs készlet
 RO Set tubulare
 FR Jeu de douilles longues
 IT Set di chiavi a bussola lunghe
 ES Juego de vasos largos
 CN 套筒组套



10
PCS
1/2"
12.7mm
CrV
50BV30
AS-DRIVE



 1/2" (12.7 mm): 10, 12, 13, 14, 15, 17, 19, 21, 22, 24 mm (L=76 mm); CrV 50BV30



YATO 		
YT-38861	1/2" (12.7 mm)	5/10

EN Socket set and accessories
 PL Zestaw nasadek z akcesoriami
 DE Steckschlüsselsatz mit Zubehör
 RU Набор головок с принадлежностями
 CZ Sada nástavců s příslušenstvím
 HU Dugókulcs készlet tartozékokkal
 RO Trusă tubulare cu accesorii
 FR Jeu de douilles et accessoires
 IT Set di chiavi a bussola con accessori
 ES Juego de vasos y accesorios
 CN 套筒组套



12
PCS
1/2"
12.7mm
CrV
50BV30
CrMo
440
72T
AS-DRIVE



 1/2" (12.7 mm): 10, 11, 12, 13, 14, 15, 17, 19, 21, 24 mm (L=38 mm); CrV 50BV30;
 1/2" (12.7 mm): (127 mm); CrV 50BV30;
 1/2" (12.7 mm): (255 mm); 72T; CrMo 440

YATO 		
YT-38821	1/2" (12.7 mm)	5/10

EN Socket and ratchet set
 PL Zestaw nasadek z grzechotką
 DE Steckschlüsselsatz mit Hebelumschaltnarke
 RU Набор головок с трещоткой
 CZ Sada nástavců a ráčny
 HU Dugókulcs készlet racsnis hajtókkal
 RO Trusă tubulare și antrenor
 FR Jeu de douilles et clé à cliquet
 IT Set di chiavi a bussola con cricchetto
 ES Juego de vasos y carraca
 CN 套筒组套



19
PCS
1/2"
12.7mm
CrV
50BV30
CrMo
440
72T
AS-DRIVE

 1/2" (12.7 mm): 8, 9, 10, 11, 12, 13, 14, 15, 16, 17, 19, 21, 22, 23, 24 mm (L=38 mm);
 27, 30, 32 mm (L=42 mm); CrV 50BV30;
 1/2" (12.7 mm): (255 mm); 72T; CrMo 440



YATO 		
YT-38681	1/2" (12.7 mm)	3/6

EN Tool set
 PL Zestaw narzędziowy
 DE Werkzeug-Satz
 RU Набор инструмента
 CZ Sada nářadí
 HU Szerszámkészlet

RO Trusa de scule
 FR Jeu d'outils
 IT Set di utensili
 ES Juego de herramientas
 CN 工具组套

12
PCS
1/2"
12.7mm
CrV
50BV30
CrMo
440
72T
AS-DRIVE



 1/2" (12.7 mm): 10, 11, 12, 13, 14, 15, 17, 19, 21, 24 mm (L=38 mm); CrV 50BV30;
 1/2" (12.7 mm): (127 mm); CrV 50BV30;
 1/2" (12.7 mm): (255 mm); 72T; CrMo 440

YATO 		
YT-38671	1/2" (12.7 mm)	10

EN Tool set
 PL Zestaw narzędziowy
 DE Werkzeug-Satz







RU Набор инструмента
 CZ Sada nářadí
 HU Szerszámkészlet

RO Trusa de scule
 FR Jeu d'outils
 IT Set di utensili

ES Juego de herramientas
 CN 工具组套

25
PCS
1/2"
12.7mm
CrV
50BV30
CrV
6140
72T
AS-DRIVE



 1/2" (12.7 mm): 10, 11, 12, 13, 14, 15, 16, 17, 18, 19, 20, 21, 22, 23, 24 mm (L=38 mm);
 27, 30, 32 mm (L=42 mm); CrV 50BV30;
 1/2" (12.7 mm): (127 mm); CrV 50BV30;
 1/2" (12.7 mm): 16, 21 mm; CrV 50BV30;
 1/2" (12.7 mm): (255 mm); CrV 50BV30;
 1/2" (12.7 mm): (255 mm); 72T; CrV 6140;
 1/2" (12.7 mm): (317 mm); CrV 50BV30;
 1/2" (12.7 mm) (F) x 3/8" (9.5 mm) (M); CrV 50BV30

YATO 		
YT-38741	1/2" (12.7 mm)	2

EN Tool set
PL Zestaw narzędziowy
DE Werkzeug-Satz
RU Набор инструмента

CZ Sada nářadí
HU Szerszámkészlet
RO Trusa de scule
FR Jeu d'outils

IT Set di utensili
ES Juego de herramientas
CN 工具组套

60 PCS	1/2" 12.7mm	1/4" 6.3mm	CrV 50BV30	CrV 6150
CrV 6140	S2	72T	AS-DRIVE	



- 1/2" (12.7 mm): 10, 11, 12, 13, 14, 15, 16, 17, 18, 19, 20, 21, 22, 24 mm (L=38 mm); 27, 30, 32 mm (L=42 mm); CrV 50BV30;
- 1/2" (12.7 mm): (127 mm; 254 mm); CrV 50BV30;
- 1/2" (12.7 mm): 16, 21 mm; CrV 50BV30;
- 1/2" (12.7 mm): 10, 11, 12, 13, 14, 15, 16, 17, 18, 19 mm (L=76 mm); CrV 50BV30;
- 3/8" (9.5 mm) (F) x 1/2" (12.7 mm) (M); CrV 50BV30;
- 1/2" (12.7 mm); CrV 50BV30;
- 1/2" (12.7 mm); (255 mm); 72T; CrV 6140;
- 1/4" (6.3 mm); (150 mm); CrV 50BV30;
- 1/4" (6.3 mm) x 1/4" (6.3 mm); CrV 6140;
- 1/4" (6.3 mm); 2, 3, 4, 5, 6, 7, 8 mm (L=25 mm); AISI S2;
- 1/4" (6.3 mm); PZ1, PZ2, PZ3 (L=25 mm); AISI S2;
- 1/4" (6.3 mm); T8, T10, T15, T20, T25, T27, T30, T40 (L=25 mm); AISI S2;
- 1/4" (6.3 mm); 4, 5.5, 6.5 mm (L=37 mm); AISI S2 / CrV 6150;
- 1/4" (6.3 mm); PH1, PH2, PH3 (L=37 mm); AISI S2 / CrV 6150

YATO		
YT-12660	1/4" (6.3 mm), 1/2" (12.7 mm)	4

EN Tool set
PL Zestaw narzędziowy
DE Werkzeug-Satz
RU Набор инструмента

CZ Sada nářadí
HU Szerszámkészlet
RO Trusa de scule
FR Jeu d'outils

IT Set di utensili
ES Juego de herramientas
CN 工具组套

72 PCS	1/2" 12.7mm	1/4" 6.3mm	CrV 50BV30	CrV 6150
CrV 6140	72T	AS-DRIVE		



- 1/2" (12.7 mm): 10, 11, 12, 13, 14, 15, 16, 17, 18, 19, 20, 21, 22, 23, 24 mm (L=38 mm); 27 mm (L=42 mm); 1/4" (6.3 mm): 4, 5, 6, 7, 8, 9, 10, 11, 12, 13 mm (L=25 mm); CrV 50BV30;
- 1/2" (12.7 mm): (127, 254 mm); 1/4" (6.3 mm); (152.4 mm); CrV 50BV30;
- 3/8" (9.5 mm) (F) x 1/2" (12.7 mm) (M); CrV 50BV30;
- 1/2" (12.7 mm); CrV 50BV30;
- 1/2" (12.7 mm): 21 mm; CrV 50BV30;
- 1/2" (12.7 mm); (255 mm); 1/4" (6.3 mm); (155 mm); 72T; CrV 6140;
- 1/4" (6.3 mm); (150 mm); CrV 50BV30;
- 1/4" (6.3 mm) x 1/4" (6.3 mm); CrV 6140;
- 1/4" (6.3 mm); 4, 5, 5.5, 6, 7 mm (L=25 mm); CrV 6150;
- 1/4" (6.3 mm): PH0, PH1, PH2, PH3 (L=25 mm); CrV 6150;
- 1/4" (6.3 mm): PZ0, PZ1, PZ2, PZ3 (L=25 mm); CrV 6150;
- 1/4" (6.3 mm): T8, T9, T10, T15, T20, T25, T27, T30, T40 (L=25 mm); CrV 6150;
- 1/4" (6.3 mm): 3, 4, 5, 6, 7, 8 mm (L=25 mm); CrV 6150;
- 1/4" (6.3 mm): S0, S1, S2, S3 (L=25 mm); CrV 6150;
- 1.25, 1.5, 2.5, 3 mm; CrV 6150

YATO		
YT-38782	1/4" (6.3 mm), 1/2" (12.7 mm)	4

EN Tool set RU Набор инструмента RO Trusa de scule ES Juego de herramientas
 PL Zestaw narzędziowy CZ Sada nářadí FR Jeu d'outils CN 工具组套
 DE Werkzeug-Satz HU Szerszámkészlet IT Set di utensili

77 PCS	1/2" 12.7mm	1/4" 6.3mm	CrV 50BV30	CrV 6150
CrMo 440	S2	72T	AS-DRIVE	



- 1/2" (12.7 mm): 10, 11, 12, 13, 14, 15, 17, 19, 22, 24 mm (L=38 mm); 27, 30, 32 mm (L=42 mm);
- 1/4" (6.3 mm): 4, 5, 6, 7, 8, 9, 10, 11, 12 mm (L=25 mm); CrV 50BV30;
- 1/2" (12.7 mm): (127, 254 mm), 1/4" (6.3 mm): (76, 101.6 mm); CrV 50BV30;
- 1/2" (12.7 mm), 1/4" (6.3 mm); CrV 50BV30;
- 1/2" (12.7 mm): 16, 21 mm; CrV 50BV30;
- 1/2" (12.7 mm): (255 mm), 1/4" (6.3 mm): (155 mm); 72T; CrMo 440;
- 1/4" (6.3 mm) x 1/4" (6.3 mm); CrV 50BV30;
- 1/4" (6.3 mm) x 1/4" (6.3 mm); CrV 50BV30;
- 1/4" (6.3 mm): 3, 4, 5.5, 7 mm (L=25 mm); AISI S2;
- 1/4" (6.3 mm): PH0, PH1, PH2, PH3 (L=25 mm); AISI S2;
- 1/4" (6.3 mm): PZ1, PZ2, PZ3 (L=25 mm); AISI S2;
- 1/4" (6.3 mm): T10, T15, T20, T25, T30 (L=25 mm); AISI S2;
- 1/4" (6.3 mm): 2, 3, 4, 5, 6 mm (L=25 mm); AISI S2;
- 7, 8, 9, 10, 11, 12, 13, 14, 15, 17, 19 mm; CrV;
- 8x9, 10x11, 12x13, 14x15 mm; CrV 50BV30;
- 1.5, 2, 2.5, 5, 6, 8, 10 mm; CrV 6150

YATO		
YT-38781	1/4" (6.3 mm), 1/2" (12.7 mm)	2

EN Tool set RU Набор инструмента RO Trusa de scule ES Juego de herramientas
 PL Zestaw narzędziowy CZ Sada nářadí FR Jeu d'outils CN 工具组套
 DE Werkzeug-Satz HU Szerszámkészlet IT Set di utensili

79 PCS	1/2" 12.7mm	1/4" 6.3mm	CrV 50BV30	CrV 6140	CrV 60
CrMo	SK5	S2	72T	AS-DRIVE	



- 1/2" (12.7 mm): 10, 11, 12, 13, 14, 16, 17, 19, 22, 24, 26 mm (L=38 mm);
- 27, 30, 32 mm (L=42 mm); 1/4" (6.3 mm): 5, 6, 7, 8, 9, 10, 11, 12, 13 mm (L=25 mm); CrV 50BV30;
- 1/2" (12.7 mm): 10, 11, 12, 13, 14, 17, 19 mm (L=76 mm); CrV 50BV30;
- 1/2" (12.7 mm): (125 mm), 1/4" (6.3 mm): (50 mm); CrV 50BV30;
- 1/2" (12.7 mm); CrV 50BV30;
- 1/2" (12.7 mm): 16, 21 mm; CrV 50BV30;
- 1/2" (12.7 mm): (255 mm), 1/4" (6.3 mm): (155 mm); 72T; CrV 6140;
- 1/4" (6.3 mm): (150 mm); CrV 50BV30;
- 1/2" (12.7 mm): (457 mm);
- 6, 7, 8, 9, 10, 11, 12, 13, 14, 16, 17, 19, 22, 24 mm; CrV;
- 2.0x50, 2.4x75 mm; S2;
- 3.0x75, 4.0x100, 6.5x150, 8.0x150 mm; S2;
- PH0x75 mm; S2;
- PH1x75, PH2x100 mm; S2;
- 180 mm;
- 160 mm;
- 160, 200 mm;
- 250 mm;
- 300 g;
- 300 mm;
- 180 mm; CrMo;
- 120 mm; CrV 60;
- SK5;
- 2.5, 3, 4, 5, 6, 8, 10 mm; CrV

YATO		
YT-38911	1/4" (6.3 mm), 1/2" (12.7 mm)	2

EN Tool set
PL Zestaw narzędziowy
DE Werkzeug-Satz

RU Набор инструмента
CZ Sada nářadí
HU Szerszámkészlet

RO Trusa de scule
FR Jeu d'outils
IT Set di utensili

ES Juego de herramientas
CN 工具组套

82
PCS

1/2"
12.7mm

1/4"
6.3mm

CrV
50BV30

CrV
6150

CrV
40

CrMo
440

S2

72T

AS-DRIVE



2



- 1/2" (12.7 mm): 14, 15, 16, 17, 18, 19, 20, 22, 24 mm (L=38 mm); 27, 30, 32 mm (L=42 mm); 1/4" (6.3 mm): 4, 4.5, 5, 5.5, 6, 7, 8, 9, 10, 11, 12, 13, 14 mm (L=25 mm); CrV 50BV30;
- 1/2" (12.7 mm): (127, 254 mm); 1/4" (6.3 mm): (50.8, 101.6 mm); CrV 50BV30;
- 3/8" (9.5 mm) (F) x 1/2" (12.7 mm) (M); CrV 50BV30;
- 1/4" (6.3 mm); (150 mm); CrV 50BV30;
- 1/2" (12.7 mm), 1/4" (6.3 mm); CrV 50BV30;
- 1/2" (12.7 mm): 16, 21 mm; CrV 50BV30;
- 1/4" (6.3 mm); (152.4 mm); CrV 40;
- 1/2" (12.7 mm); (255 mm); 1/4" (6.3 mm); (155 mm); 72T; CrMo 440;
- 1/4" (6.3 mm); (150 mm); CrV 50BV30;
- 1/2" (12.7 mm) x 5/16" (7.9 mm); CrV 50BV30;
- 1/4" (6.3 mm) x 1/4" (6.3 mm); CrV 50BV30;
- 5/16" (7.9 mm): 8, 10, 12 mm (L=30 mm); AISI S2;
- 5/16" (7.9 mm): PH3, PH4 (L=30 mm); AISI S2;
- 5/16" (7.9 mm): PZ3, PZ4 (L=30 mm); AISI S2;
- 5/16" (7.9 mm): T40, T45, T50, T55 (L=30 mm); AISI S2;
- 5/16" (7.9 mm): 8, 10, 12, 14 mm (L=30 mm); AISI S2;
- 1/4" (6.3 mm): 4, 5.5, 7 mm (L=37 mm); AISI S2 / CrV 6150;
- 1/4" (6.3 mm): PH1, PH2 (L=37 mm); AISI S2 / CrV 6150;
- 1/4" (6.3 mm): PZ1, PZ2 (L=37 mm); AISI S2 / CrV 6150;
- 1/4" (6.3 mm): T8, T10, T15, T20, T25, T30 (L=37 mm); AISI S2 / CrV 6150;
- 1/4" (6.3 mm): 3, 4, 5, 6 mm (L=37 mm); AISI S2 / CrV 6150;
- 8, 10, 11, 12, 13, 14, 17, 19, 22 mm; CrV

YATO	1/4" (6.3 mm), 1/2" (12.7 mm)	2
YT-12691		

EN Tool set
PL Zestaw narzędziowy
DE Werkzeug-Satz

RU Набор инструмента
CZ Sada nářadí
HU Szerszámkészlet

RO Trusa de scule
FR Jeu d'outils
IT Set di utensili

ES Juego de herramientas
CN 工具组套

94
PCS

1/2"
12.7mm

1/4"
6.3mm

CrV
50BV30

CrV
6150

CrV
40

CrMo
440

S2

72T

AS-DRIVE



- 1/2" (12.7 mm): 10, 11, 12, 13, 14, 15, 16, 17, 18, 19, 20, 21, 22, 23, 24 mm (L=38 mm); 27, 30, 32 mm (L=42 mm); 1/4" (6.3 mm): 4, 4.5, 5, 5.5, 6, 7, 8, 9, 10, 11, 12, 13, 14 mm (L=25 mm); CrV 50BV30;
- 1/2" (12.7 mm): 14, 15, 17, 19 mm (L=76 mm); 1/4" (6.3 mm): 6, 7, 8, 9, 10, 11, 12, 13 mm (L=50 mm); CrV 50BV30;
- 1/2" (12.7 mm): (127, 254 mm); 1/4" (6.3 mm): (50.8, 101.6 mm); CrV 50BV30;
- 3/8" (9.5 mm) (F) x 1/2" (12.7 mm) (M); CrV 50BV30;
- 1/4" (6.3 mm); (150 mm); CrV 50BV30;
- 1/2" (12.7 mm), 1/4" (6.3 mm); CrV 50BV30;
- 1/2" (12.7 mm): 16, 21 mm; CrV 50BV30;
- 1/4" (6.3 mm); (152.4 mm); CrV 40;
- 1/2" (12.7 mm); (255 mm); 1/4" (6.3 mm); (155 mm); 72T; CrMo 440;
- 1/4" (6.3 mm); (150 mm); CrV 50BV30;
- 1/2" (12.7 mm) x 5/16" (7.9 mm); CrV 50BV30;
- 1/4" (6.3 mm) x 1/4" (6.3 mm); CrV 50BV30;
- 5/16" (7.9 mm): 8, 10, 12 mm (L=30 mm); AISI S2;
- 5/16" (7.9 mm): PH3, PH4 (L=30 mm); AISI S2;
- 5/16" (7.9 mm): PZ3, PZ4 (L=30 mm); AISI S2;
- 5/16" (7.9 mm): T40, T45, T50, T55 (L=30 mm); AISI S2;
- 5/16" (7.9 mm): 8, 10, 12, 14 mm (L=30 mm); AISI S2;
- 1/4" (6.3 mm): 4, 5.5, 7 mm (L=37 mm); AISI S2 / CrV 6150;
- 1/4" (6.3 mm): PH1, PH2 (L=37 mm); AISI S2 / CrV 6150;
- 1/4" (6.3 mm): PZ1, PZ2 (L=37 mm); AISI S2 / CrV 6150;
- 1/4" (6.3 mm): T8, T10, T15, T20, T25, T30 (L=37 mm); AISI S2 / CrV 6150;
- 1/4" (6.3 mm): 3, 4, 5, 6 mm (L=37 mm); AISI S2 / CrV 6150;
- 1.5, 2, 2.5 mm; CrV 6150

YATO	1/4" (6.3 mm), 1/2" (12.7 mm)	2
YT-12681		

EN Tool set
 PL Zestaw narzędziowy
 DE Werkzeug-Satz

RU Набор инструмента
 CZ Sada nářadí
 HU Szerszámkészlet























RO Trusa de scule
 FR Jeu d'outils
 IT Set di utensili



ES Juego de herramientas
 CN 工具组套

108 PCS	1/2" 12.7mm	1/4" 6.3mm	CrV 50BV30	CrV 6150	CrV 40
CrMo 440	S2	72T	AS-DRIVE		

2



-  1/2" (12.7 mm): 10, 11, 12, 13, 14, 15, 16, 17, 18, 19, 20, 21, 22, 24 mm (L=38 mm); 27, 30, 32 mm (L=42 mm), 1/4" (6.3 mm): 4, 4.5, 5, 5.5, 6, 7, 8, 9, 10, 11, 12, 13, 14 mm (L=25 mm); CrV 50BV30;
-  1/2" (12.7 mm): 14, 15, 17, 19, 22 mm (L=76 mm);
-  1/4" (6.3 mm): 6, 7, 8, 9, 10, 11, 12, 13 mm (L=50 mm); CrV 50BV30;
-  1/2" (12.7 mm): E10, E11, E12, E14, E16, E18, E20, E24, 1/4" (6.3 mm): E4, E5, E6, E7, E8; CrV 50BV30;
-  1/2" (12.7 mm): (127, 254 mm), 1/4" (6.3 mm): (50.8, 101.6 mm); CrV 50BV30;
-  3/8" (9.5 mm) (F) x 1/2" (12.7 mm) (M); CrV 50BV30;
-  1/2" (12.7 mm), 1/4" (6.3 mm); CrV 50BV30;
-  1/2" (12.7 mm): 16, 21 mm; CrV 50BV30;
-  1/4" (6.3 mm): (152.4 mm); CrV 40;
-  1/2" (12.7 mm): (255 mm), 1/4" (6.3 mm): (155 mm); 72T; CrMo 440;
-  1/4" (6.3 mm): (150 mm); CrV 50BV30;
-  1/2" (12.7 mm) x 5/16" (7.9 mm); CrV 50BV30;
-  5/16" (7.9 mm): 8, 10, 12 mm (L=30 mm); AISI S2;
-  5/16" (7.9 mm): PH3, PH4 (L=30 mm); AISI S2;
-  5/16" (7.9 mm): PZ3, PZ4 (L=30 mm); AISI S2;
-  5/16" (7.9 mm): T40, T45, T50, T55, T60 (L=30 mm); AISI S2;
-  5/16" (7.9 mm): 7, 8, 10, 12, 14 mm (L=30 mm); AISI S2;
-  1/4" (6.3 mm): 4, 5.5, 6.5 mm (L=37 mm); AISI S2 / CrV 50BV30;
-  1/4" (6.3 mm): PH1, PH2 (L=37 mm); AISI S2 / CrV 50BV30;
-  1/4" (6.3 mm): PZ1, PZ2 (L=37 mm); AISI S2 / CrV 50BV30;
-  1/4" (6.3 mm): T8, T10, T15, T20, T25, T27, T30 (L=37 mm); AISI S2 / CrV 50BV30;
-  1/4" (6.3 mm): 3, 4, 5, 6 mm (L=37 mm); AISI S2 / CrV 50BV30;
-  1.5, 2, 2.5 mm; CrV 6150

YATO 		
YT-38791	1/4" (6.3 mm), 1/2" (12.7 mm)	2

EN Tool set
 PL Zestaw narzędziowy
 DE Werkzeug-Satz

















RU Набор инструмента

CZ Sada nářadí
 HU Szerszámkészlet
 RO Trusa de scule
 FR Jeu d'outils

IT Set di utensili
 ES Juego de herramientas
 CN 工具组套

109 PCS	1/2" 12.7mm	1/4" 6.3mm	CrV 50BV30	CrV 6150	CrV 6140
CrMo 440	S2	72T	AS-DRIVE		



-  1/2" (12.7 mm): 12, 13, 14, 15, 16, 17, 18, 19, 20, 21, 22, 24 mm (L=38 mm); 27, 30, 32 mm (L=42 mm);
-  1/4" (6.3 mm): 4, 4.5, 5, 5.5, 6, 7, 8, 9, 10, 11, 12, 13, 14 mm (L=25 mm); CrV 50BV30;
-  1/2" (12.7 mm): 10, 12, 13, 14, 17, 19 mm (L=76 mm), 1/4" (6.3 mm): 4, 5, 6, 7, 8, 9 mm (L=50 mm); CrV 50BV30;
-  1/2" (12.7 mm): E10, E12, E14, E16, E18, E20, E22, E24; CrV 6150;
-  1/2" (12.7 mm): (254 mm), 1/4" (6.3 mm): (152.4 mm); CrV 50BV30;
-  3/8" (9.5 mm) (F) x 1/2" (12.7 mm) (M), 3/8" (9.5 mm) (F) x 1/4" (6.3 mm) (M); CrV 50BV30;
-  1/2" (12.7 mm), 1/4" (6.3 mm); CrV 50BV30;
-  1/2" (12.7 mm): 16, 21 mm; CrV 50BV30;
-  1/2" (12.7 mm): (255 mm), 1/4" (6.3 mm): (155 mm); 72T; CrMo 440;
-  1/4" (6.3 mm): (150 mm); CrV 50BV30;
-  1/4" (6.3 mm): 4, 5.5, 6.5 mm (L=37 mm); AISI S2 / CrV 6150;
-  1/4" (6.3 mm): PH1, PH2, PH3 (L=37 mm); AISI S2 / CrV 6150;
-  1/4" (6.3 mm): PZ2, PZ3 (L=37 mm); AISI S2 / CrV 6150;
-  1/4" (6.3 mm): T8, T10, T15, T20, T25 (L=37 mm); AISI S2 / CrV 6150;
-  1/4" (6.3 mm): T10, T15, T20, T25, T40 (L=37 mm); AISI S2 / CrV 6150;
-  1/4" (6.3 mm): 3, 4, 5, 6 mm (L=37 mm); AISI S2 / CrV 6150;
- 8, 9, 10, 11, 12, 13, 14, 15, 16, 17, 18, 19 mm; CrV;
- 8x9, 10x11, 12x13, 14x15 mm; CrV 50BV30;
- 8x10, 12x13, 17x19 mm; CrV 6140;
- 3x75, 4x100, 6x150, PH1x75, PH2x100, PH3x150 mm; S2;
- 180 mm;
- 160 mm;
- 300 g

YATO 		
YT-38891	1/4" (6.3 mm), 1/2" (12.7 mm)	2



























EN Tool set
PL Zestaw narzędziowy
DE Werkzeug-Satz
RU Набор инструмента



CZ Sada nářadí
HU Szerszámkészlet
RO Trusa de scule
FR Jeu d'outils

IT Set di utensili
ES Juego de herramientas
CN 工具组套

122 PCS	1/2" 12.7mm	1/4" 6.3mm	CrV 50BV30	CrV 6150
CrMo 440	S2	72T	AS-DRIVE	



-  1/2" (12.7 mm): 12, 13, 14, 15, 16, 17, 18, 19, 20, 21, 22, 24 mm (L=38 mm); 27, 30, 32 mm (L=42 mm);
- 1/4" (6.3 mm): 4, 4.5, 5, 5.5, 6, 7, 8, 9, 10, 11, 12, 13, 14 mm (L=25 mm); CrV 50BV30;
-  1/2" (12.7 mm): 10, 12, 13, 14, 17, 19 mm (L=76 mm); 1/4" (6.3 mm): 4, 5, 6, 7, 8, 9 mm (L=50 mm); CrV 50BV30;
-  1/2" (12.7 mm): E10, E12, E14, E16, E18, E20, E22, E24; CrV 6150;
-  1/2" (12.7 mm); (254 mm); 1/4" (6.3 mm); (152.4 mm); CrV 50BV30;
-  3/8" (9.5 mm) (F) x 1/2" (12.7 mm) (M); 3/8" (9.5 mm) (F) x 1/4" (6.3 mm) (M); CrV 50BV30;
-  1/2" (12.7 mm); 1/4" (6.3 mm); CrV 50BV30;
-  1/2" (12.7 mm): 16, 21 mm; CrV 50BV30;
-  1/2" (12.7 mm); (255 mm); 1/4" (6.3 mm); (155 mm); 72T; CrMo 440;
-  1/4" (6.3 mm); (150 mm); CrV 50BV30;
-  1/4" (6.3 mm) x 1/4" (6.3 mm); CrV 50BV30;
-  1/4" (6.3 mm): 3, 4, 5, 6 mm (L=25 mm); AISI S2;
-  1/4" (6.3 mm): PH0, PH1, PH2 (L=25 mm); AISI S2;
-  1/4" (6.3 mm): PZ0, PZ1, PZ2 (L=25 mm); AISI S2;
-  1/4" (6.3 mm): 4, 5.5, 6.5 mm (L=37 mm); AISI S2 / CrV 6150;
-  1/4" (6.3 mm): PH1, PH2, PH3 (L=37 mm); AISI S2 / CrV 6150;
-  1/4" (6.3 mm): PZ2, PZ3 (L=37 mm); AISI S2 / CrV 6150;
-  1/4" (6.3 mm): T8, T10, T15, T20, T25 (L=37 mm); AISI S2 / CrV 6150;
-  1/4" (6.3 mm): T10, T15, T20, T25, T40 (L=37 mm); AISI S2 / CrV 6150;
-  1/4" (6.3 mm): 3, 4, 5, 6 mm (L=37 mm); AISI S2 / CrV 6150;
-  8, 9, 10, 11, 12, 13, 14, 15, 16, 17, 18, 19 mm; CrV;
-  4x100, 6x150, PH2x100, PH3x150 mm; S2;
-  180 mm;
-  160 mm;
-  160 mm;
-  250 mm; CrV;
-  300 g;
-  2, 2.5, 3, 4, 5, 6, 7, 8, 10 mm; CrV 6150

YATO 		
YT-38901	1/4" (6.3 mm), 1/2" (12.7 mm)	2

















EN Tool set
PL Zestaw narzędziowy
DE Werkzeug-Satz
RU Набор инструмента



CZ Sada nářadí
HU Szerszámkészlet
RO Trusa de scule
FR Jeu d'outils

IT Set di utensili
ES Juego de herramientas
CN 工具组套

111 PCS	1/2" 12.7mm	3/8" 9.5mm	1/4" 6.3mm	CrV 50BV30	CrV 6150
CrMo 440	S2	72T	AS-DRIVE		



-  1/2" (12.7 mm): 14, 15, 16, 17, 18, 19, 20, 21, 22, 23, 24 mm (L=38 mm); 27, 30, 32 mm (L=42 mm);
- 3/8" (9.5 mm): 9, 10, 11, 12, 13, 14, 15, 16 mm (L=28 mm); 17, 18, 19 mm (L=30 mm);
- 1/4" (6.3 mm): 3.5, 4, 4.5, 5, 5.5, 6, 7, 8, 9, 10, 11, 12, 13 mm (L=25 mm); CrV 50BV30;
-  1/2" (12.7 mm): (127, 254 mm); 3/8" (9.5 mm); (76, 152.4 mm); 1/4" (6.3 mm); (50.8, 152.4 mm); CrV 50BV30;
-  3/8" (9.5 mm) (F) x 1/2" (12.7 mm) (M); 1/2" (12.7 mm) (F) x 3/8" (9.5 mm) (M);
- 3/8" (9.5 mm) (F) x 1/4" (6.3 mm) (M); CrV 50BV30;
-  1/2" (12.7 mm); 3/8" (9.5 mm); 1/4" (6.3 mm); CrV 50BV30;
-  1/2" (12.7 mm): 16, 21 mm; 3/8" (9.5 mm): 16, 21 mm; CrV 50BV30;
-  1/2" (12.7 mm); (255 mm); 3/8" (9.5 mm); (200 mm); 1/4" (6.3 mm); (155 mm); 72T; CrMo 440;
-  1/4" (6.3 mm); (150 mm); CrV 50BV30;
-  1/2" (12.7 mm) x 5/16" (7.9 mm); 3/8" (9.5 mm) x 5/16" (7.9 mm); CrV 50BV30;
-  5/16" (7.9 mm): 6, 6.5, 8 mm (L=30 mm); AISI S2;
-  5/16" (7.9 mm): PH2, PH3 (L=30 mm); AISI S2;
-  5/16" (7.9 mm): PZ2, PZ3 (L=30 mm); AISI S2;
-  5/16" (7.9 mm): T27, T30, T35, T40, T45 (L=30 mm); AISI S2;
-  5/16" (7.9 mm): 5.5, 6, 6.5 mm (L=30 mm); AISI S2;
-  1/4" (6.3 mm): 4, 5.5, 6.5 mm (L=37 mm); AISI S2 / CrV 6150;
-  1/4" (6.3 mm): PH1, PH2 (L=37 mm); AISI S2 / CrV 6150;
-  1/4" (6.3 mm): PZ1, PZ2 (L=37 mm); AISI S2 / CrV 6150;
- 1/4" (6.3 mm): T8, T10, T15, T20, T25 (L=37 mm); AISI S2 / CrV 6150;
- 1/4" (6.3 mm): T10, T15, T20, T25, T40 (L=37 mm); AISI S2 / CrV 6150;
- 1/4" (6.3 mm): 3, 4, 5, 6 mm (L=37 mm); AISI S2 / CrV 6150;
- 8, 9, 10, 11, 12, 13, 14, 15, 16, 17, 18, 19 mm; CrV;
- 1.5, 2, 2.5 mm; CrV 6150



















YATO 		
YT-38831	1/4" (6.3 mm), 3/8" (9.5 mm), 1/2" (12.7 mm)	2



EN Tool set
 PL Zestaw narzędziowy
 DE Werkzeug-Satz
 RU Набор инструмента
 CZ Sada nářadí
 HU Szerszámkészlet

RO Trusa de scule
 FR Jeu d'outils
 IT Set di utensili
 ES Juego de herramientas
 CN 工具组套

120 PCS	1/2" 12,7mm	3/8" 9,5mm	1/4" 6,3mm
METRIC SAE	CrV 50BV30	CrV 6150	CrMo 440
S2	72T	AS-DRIVE	



-  1/2" (12.7 mm): 20, 21, 22, 24 mm (L=38 mm); 27, 30, 32 mm (L=42 mm);
- 3/8" (9.5 mm): 9, 10, 11, 12, 13, 14, 15, 16 mm (L=28 mm); 17, 18, 19 mm (L=30 mm);
- 1/4" (6.3 mm): 4, 5, 6, 7, 8, 9, 10, 11, 12, 13 mm (L=25 mm); CrV 50BV30;
-  3/8" (9.5 mm): 13, 14, 15, 17 mm (L=63 mm); 1/4" (6.3 mm): 8, 9, 10, 12 mm (L=50 mm); CrV 50BV30;
-  1/2" (12.7 mm) x 15/16" (23.8 mm), 1/2" (12.7 mm) x 1" (25.4 mm), 1/2" (12.7 mm) x 1-1/16" (27.0 mm),
- 1/2" (12.7 mm) x 1-1/4" (31.8 mm), 3/8" (9.5 mm) x 3/8" (9.5 mm), 3/8" (9.5 mm) x 7/16" (11.1 mm),
- 3/8" (9.5 mm) x 1/2" (12.7 mm), 3/8" (9.5 mm) x 9/16" (14.3 mm), 3/8" (9.5 mm) x 5/8" (15.9 mm),
- 3/8" (9.5 mm) x 11/16" (17.5 mm), 3/8" (9.5 mm) x 3/4" (19.0 mm), 3/8" (9.5 mm) x 13/16" (20.6 mm),
- 3/8" (9.5 mm) x 7/8" (22.2 mm), 1/4" (6.3 mm) x 5/32" (4.0 mm), 1/4" (6.3 mm) x 3/16" (4.8 mm),
- 1/4" (6.3 mm) x 7/32" (5.6 mm), 1/4" (6.3 mm) x 1/4" (6.3 mm), 1/4" (6.3 mm) x 9/32" (7.1 mm),
- 1/4" (6.3 mm) x 5/16" (7.9 mm), 1/4" (6.3 mm) x 11/32" (8.7 mm), 1/4" (6.3 mm) x 3/8" (9.5 mm),
- 1/4" (6.3 mm) x 7/16" (11.1 mm), 1/4" (6.3 mm) x 1/2" (12.7 mm); CrV 50BV30;
-  1/2" (12.7 mm): 17, 19, 21, 23 mm; CrV 50BV30;
-  3/8" (9.5 mm): E8, E10, E11, E12, E14, E16, E18, E20; CrV 6150;
-  1/2" (12.7 mm): (127, 254 mm), 3/8" (9.5 mm): (76, 152.4 mm), 1/4" (6.3 mm): (50.8 mm); CrV 50BV30;
-  1/2" (12.7 mm), 3/8" (9.5 mm), 1/4" (6.3 mm); CrV 50BV30;
-  3/8" (9.5 mm): 16, 21 mm; CrV 50BV30;
-  1/2" (12.7 mm): (255 mm), 3/8" (9.5 mm): (200 mm), 1/4" (6.3 mm): (155 mm); 72T; CrMo 440;
-  1/4" (6.3 mm): (150 mm); CrV 50BV30;
-  1/4" (6.3 mm) x 1/4" (6.3 mm); CrV 50BV30;
-  1/4" (6.3 mm): T10, T15, T20, T25, T27, T30, T40 (L=25 mm); AISI S2;
-  3/8" (9.5 mm): 5.5, 6.5 mm (L=50 mm); AISI S2 / CrV 6150;
-  3/8" (9.5 mm): PH1, PH2 (L=50 mm); AISI S2 / CrV 6150;
-  3/8" (9.5 mm): PZ1, PZ2 (L=50 mm); AISI S2 / CrV 6150;
-  3/8" (9.5 mm): T20, T30, T40, T45, T50, T55, T60 (L=50 mm); AISI S2 / CrV 6150;
-  3/8" (9.5 mm): 3, 4, 5, 6 mm (L=50 mm); AISI S2 / CrV 6150;
-  8, 9, 10, 11, 12, 13, 14, 17, 18, 19 mm; CrV



























YATO 	○	
YT-38801	1/4" (6.3 mm), 3/8" (9.5 mm), 1/2" (12.7 mm)	2

EN Tool set
 PL Zestaw narzędziowy
 DE Werkzeug-Satz
 RU Набор инструмента
 CZ Sada nářadí
 HU Szerszámkészlet

RO Trusa de scule
 FR Jeu d'outils
 IT Set di utensili
 ES Juego de herramientas
 CN 工具组套

126 PCS	1/2" 12,7mm	3/8" 9,5mm	1/4" 6,3mm
CrV 50BV30	CrV 6150	CrV 6140	S2
72T	AS-DRIVE		



-  1/2" (12.7 mm): 20, 21, 22, 24 mm (L=38 mm); 27, 30, 32 mm (L=42 mm);
- 3/8" (9.5 mm): 9, 10, 11, 12, 13, 14, 15, 16 mm (L=28 mm); 17, 18, 19 mm (L=30 mm);
- 1/4" (6.3 mm): 4, 4.5, 5, 5.5, 6, 7, 8, 9, 10, 11, 12, 13 mm (L=25 mm); CrV 50BV30;
-  3/8" (9.5 mm): 13, 14, 15, 17 mm (L=63 mm); 1/4" (6.3 mm): 8, 9, 10, 12 (L=50 mm); CrV 50BV30;
-  3/8" (9.5 mm): E8, E10, E11, E12, E14, E16, E18, E20; CrV 6150;
-  1/2" (12.7 mm): (127, 254 mm), 3/8" (9.5 mm): (76, 152.4 mm), 1/4" (6.3 mm): (50.8 mm); CrV 50BV30;
-  3/8" (9.5 mm) (F) x 1/2" (12.7 mm) (M); CrV 50BV30; 1/2" (12.7 mm), 3/8" (9.5 mm), 1/4" (6.3 mm); CrV 50BV30;
-  3/8" (9.5 mm): 16, 21 mm; CrV 50BV30;
-  1/2" (12.7 mm): (255 mm), 3/8" (9.5 mm): (200 mm), 1/4" (6.3 mm): (155 mm); 72T; CrV 6140;
-  1/4" (6.3 mm): (150 mm); CrV 50BV30;
-  1/2" (12.7 mm) (F) x 3/8" (9.5 mm) (M), 3/8" (9.5 mm) (F) x 1/2" (12.7 mm) (M), 3/8" (9.5 mm) (F) x 1/4" (6.3 mm) (M); CrV 50BV30;
-  1/4" (6.3 mm) x 1/4" (6.3 mm); CrV 6140;
-  1/4" (6.3 mm): 4, 5, 6.5 mm (L=25 mm); AISI S2;
-  1/4" (6.3 mm): PH1, PH3 (L=25 mm); AISI S2;
-  1/4" (6.3 mm): PZ1, PZ2 (L=25 mm); AISI S2;
-  1/4" (6.3 mm): T10, T15, T20, T25, T27, T30, T40 (L=25 mm); AISI S2;
-  1/4" (6.3 mm): 3, 4, 5, 6 mm (L=25 mm); AISI S2;
-  3/8" (9.5 mm): 5.5, 6.5 mm (L=50 mm); AISI S2 / CrV 6150;
-  3/8" (9.5 mm): PH1, PH2 x2 (L=50 mm); AISI S2 / CrV 6150;
-  3/8" (9.5 mm): T20, T30, T40 (L=50 mm), 1/2" (12.7 mm): T52 (L=125 mm); AISI S2 / CrV 6150;
-  3/8" (9.5 mm): T45, T50, T55, T60 (L=50 mm); AISI S2 / CrV 6150;
-  3/8" (9.5 mm): 3, 4, 5, 6, 7 mm (L=50 mm); AISI S2 / CrV 6150;
-  8, 10, 12, 13, 14, 16, 17, 18, 19 mm; CrV;
-  8x10 mm, 11x12 mm; CrV 6140;
-  6x100 mm, PH2x100 mm; CrV 6150;
-  6-24 V;
-  150 mm;
-  1/2" (12.7 mm), 3/8" (9.5 mm): 63-120 mm; CrV;
-  1.5, 2, 2.5, 3, 4, 5, 6, 8, 10 mm; S2

YATO 	○	
YT-38875	1/4" (6.3 mm), 3/8" (9.5 mm), 1/2" (12.7 mm)	2

EN Tool set
PL Zestaw narzędziowy
DE Werkzeug-Satz
RU Набор инструмента
CZ Sada nářadí
HU Szerszámkészlet

RO Trusa de scule
FR Jeu d'outils
IT Set di utensili
ES Juego de herramientas
CN 工具组套

128
PCS

1/2"
12,7mm

3/8"
9,5mm

1/4"
6,3mm

CrV
50BV30

CrV
6150

CrMo
440

S2

72T

AS-DRIVE



2



- 1/2" (12.7 mm): 14, 15, 16, 17, 18, 19, 20, 21, 22, 24 mm (L=38 mm); 27, 30, 32 mm (L=42 mm);
- 3/8" (9.5 mm): 10, 11, 12, 13, 14, 15, 16 mm (L=28 mm); 17, 18 mm (L=30 mm);
- 1/4" (6.3 mm): 6, 7, 8, 9, 10, 11, 12, 13 mm (L=25 mm); CrV 50BV30;
- 1/2" (12.7 mm): 17, 18, 19, 22 mm (L=76 mm); 3/8" (9.5 mm): 8, 10, 12, 13, 14, 15 mm (L=63 mm);
- 1/4" (6.3 mm): 6, 7, 8, 10, 12, 13 mm (L=50 mm); CrV 50BV30;
- 1/2" (12.7 mm): 17, 19, 21, 22 mm; CrV 50BV30;
- 3/8" (9.5 mm): E8, E10, E11, E12, E14, E16; CrV 6150;
- 1/2" (12.7 mm): (127, 254 mm); 3/8" (9.5 mm): (152.4, 254 mm); 1/4" (6.3 mm): (50.8, 101.6 mm); CrV 50BV30;
- 3/8" (9.5 mm) (F) x 1/2" (12.7 mm) (M); CrV 50BV30;
- 1/2" (12.7 mm), 3/8" (9.5 mm), 1/4" (6.3 mm); CrV 50BV30;
- 1/2" (12.7 mm): 16, 21 mm; CrV 50BV30;
- 3/8" (9.5 mm): (198 mm); 1/4" (6.3 mm): (152.4 mm); CrV 50BV30;
- 1/2" (12.7 mm): (255 mm); 3/8" (9.5 mm): (200 mm); 1/4" (6.3 mm): (155 mm); 72T; CrMo 440;
- 1/4" (6.3 mm): (150 mm); CrV 50BV30;
- 1/2" (12.7 mm): (250 mm); CrV 50BV30;
- 3/8" (9.5 mm) x 5/16" (7.9 mm); CrV 50BV30;
- 1/2" (12.7 mm) x 3/8" (9.5 mm), 3/8" (9.5 mm) x 1/4" (6.3 mm); CrV 50BV30;
- 1/4" (6.3 mm) x 1/4" (6.3 mm); CrV 50BV30;
- 3/8" (9.5 mm): 5.5, 6.5 mm (L=70 mm); AISI S2;
- 3/8" (9.5 mm): PH1, PH2, PH3 (L=70 mm); AISI S2;
- 3/8" (9.5 mm): T20, T30, T40, T45, T50, T55 (L=70 mm); AISI S2;
- 3/8" (9.5 mm): 6, 7, 8, 10, 12 mm (L=70 mm); AISI S2;
- 1/4" (6.3 mm): PZ1, PZ2 (L=25 mm); AISI S2;
- 1/4" (6.3 mm): T8, T10 (L=25 mm); AISI S2;
- 1/4" (6.3 mm): 4, 5.5, 6.5 mm (L=37 mm); AISI S2 / CrV 6150;
- 1/4" (6.3 mm): PH1, PH2 (L=37 mm); AISI S2 / CrV 6150;
- 1/4" (6.3 mm): T8, T10, T15, T20, T25, T30, T40 (L=37 mm); AISI S2 / CrV 6150;
- 1/4" (6.3 mm): 3, 4, 5, 6 mm (L=37 mm); AISI S2 / CrV 6150;
- 8, 10, 12, 13, 14, 15, 16, 17, 18, 19 mm; CrV;
- 1.5, 2, 2.5 mm; CrV 6150

YATO		
YT-38872	1/4" (6.3 mm), 3/8" (9.5 mm), 1/2" (12.7 mm)	2

EN Tool set
PL Zestaw narzędziowy
DE Werkzeug-Satz
RU Набор инструмента
CZ Sada nářadí
HU Szerszámkészlet

RO Trusa de scule
FR Jeu d'outils
IT Set di utensili
ES Juego de herramientas
CN 工具组套

129
PCS

1/2"
12,7mm

3/8"
9,5mm

1/4"
6,3mm

CrV
50BV30

CrV
6150

CrMo
440

S2

72T

AS-DRIVE



- 1/2" (12.7 mm): 12, 13, 14, 15, 16, 17, 18, 19, 20, 21, 22, 24 mm (L=38 mm); 27, 30, 32 mm (L=42 mm);
- 3/8" (9.5 mm): 10, 11, 12, 13, 14, 15, 16 mm (L=28 mm); 17, 18, 19 mm (L=30 mm);
- 1/4" (6.3 mm): 4, 4.5, 5, 5.5, 6, 7, 8, 9, 10, 11, 12, 13, 14 mm (L=25 mm); CrV 50BV30;
- 1/2" (12.7 mm): 10, 12, 13, 14, 17, 19 mm (L=76 mm); 1/4" (6.3 mm): 4, 5, 6, 7, 8, 9 mm (L=50 mm); CrV 50BV30;
- 1/2" (12.7 mm): 17, 19, 21, 23 mm; CrV 50BV30;
- 3/8" (9.5 mm): E8, E10, E11, E12, E14, E16, E18, E20; CrV 6150;
- 1/2" (12.7 mm): (127, 254 mm); 3/8" (9.5 mm): (76, 152.4 mm); 1/4" (6.3 mm): (50.8 mm); CrV 50BV30;
- 1/2" (12.7 mm), 3/8" (9.5 mm), 1/4" (6.3 mm); CrV 50BV30;
- 3/8" (9.5 mm): 16, 21 mm; CrV 50BV30;
- 1/2" (12.7 mm): (255 mm); 3/8" (9.5 mm): (200 mm); 1/4" (6.3 mm): (155 mm); 72T; CrMo 440;
- 1/4" (6.3 mm): (150 mm); CrV 50BV30;
- 3/8" (9.5 mm): 4, 5.5, 6.5 mm (L=50 mm); AISI S2 / CrV 6150;
- 3/8" (9.5 mm): PH1, PH2, PH3 (L=50 mm); AISI S2 / CrV 6150;
- 3/8" (9.5 mm): PZ1, PZ2, PZ3 (L=50 mm); AISI S2 / CrV 6150;
- 3/8" (9.5 mm): T20, T30, T40, T45, T50, T55, T60 (L=50 mm); AISI S2 / CrV 6150;
- 3/8" (9.5 mm): 3, 4, 5, 6, 8, 10 mm (L=50 mm); AISI S2 / CrV 6150;
- 8, 10, 11, 12, 13, 14, 15, 16, 17, 18, 19, 22 mm; CrV;
- 3x75, 4x100, 6x150, PH1x75, PH2x100, PH3x150 mm; S2;
- 160 mm;
- 160 mm;
- 160 mm;
- 1.5, 2, 2.5, 3, 4, 5, 6, 7, 8, 10 mm; CrV 6150

YATO		
YT-38881	1/4" (6.3 mm), 3/8" (9.5 mm), 1/2" (12.7 mm)	2

EN Tool set RU Набор инструмента RO Trusa de scule ES Juego de herramientas
 PL Zestaw narzędziowy CZ Sada nářadí FR Jeu d'outils CN 工具组套
 DE Werkzeug-Satz HU Szerszámkészlet IT Set di utensili

150 PCS	1/2" 12.7mm	3/8" 9.5mm	1/4" 6.3mm
METRIC SAE	CrV 50BV30	CrV 6150	CrV 6140
CrMo 440	S2	72T	AS-DRIVE

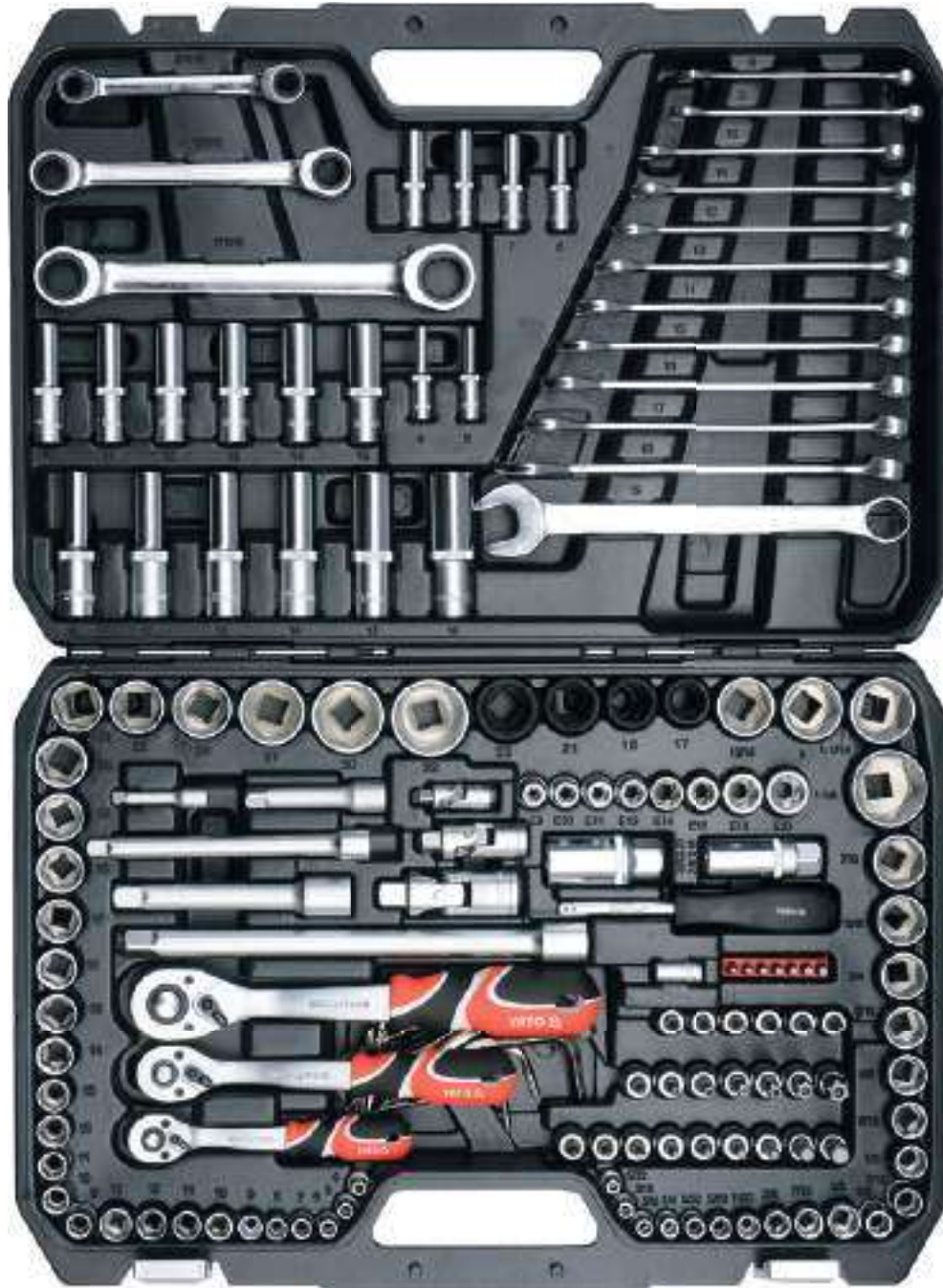

- 1/2" (12.7 mm): 20, 21, 22, 24 mm (L=38 mm); 27, 30, 32 mm (L=42 mm), 3/8" (9.5 mm): 9, 10, 11, 12, 13, 14, 15, 16 mm (L=28 mm); 17, 18, 19 mm (L=30 mm), 1/4" (6.3 mm): 4, 5, 6, 7, 8, 9, 10, 11, 12, 13 mm (L=25 mm); CrV 50BV30;
- 1/2" (12.7 mm): 10, 12, 13, 14, 17, 19 mm (L=76 mm), 3/8" (9.5 mm): 10, 11, 12, 13, 14, 15 mm (L=63 mm), 1/4" (6.3 mm): 4, 5, 6, 7, 8, 9 mm (L=50 mm); CrV 50BV30;
- 1/2" (12.7 mm) x 15/16" (23.8 mm), 1/2" (12.7 mm) x 1" (25.4 mm), 1/2" (12.7 mm) x 1-1/16" (27.0 mm), 1/2" (12.7 mm) x 1-1/4" (31.8 mm), 3/8" (9.5 mm) x 3/8" (9.5 mm), 3/8" (9.5 mm) x 7/16" (11.1 mm), 3/8" (9.5 mm) x 1/2" (12.7 mm), 3/8" (9.5 mm) x 9/16" (14.3 mm), 3/8" (9.5 mm) x 5/8" (15.9 mm), 3/8" (9.5 mm) x 11/16" (17.5 mm), 3/8" (9.5 mm) x 3/4" (19.0 mm), 3/8" (9.5 mm) x 13/16" (20.6 mm), 3/8" (9.5 mm) x 7/8" (22.2 mm), 1/4" (6.3 mm) x 5/32" (4.0 mm), 1/4" (6.3 mm) x 3/16" (4.8 mm), 1/4" (6.3 mm) x 7/32" (5.6 mm), 1/4" (6.3 mm) x 1/4" (6.3 mm), 1/4" (6.3 mm) x 9/32" (7.1 mm), 1/4" (6.3 mm) x 5/16" (7.9 mm), 1/4" (6.3 mm) x 11/32" (8.7 mm), 1/4" (6.3 mm) x 3/8" (9.5 mm), 1/4" (6.3 mm) x 7/16" (11.1 mm), 1/4" (6.3 mm) x 1/2" (12.7 mm); CrV 50BV30;
- 1/2" (12.7 mm): 17, 19, 21, 23 mm; CrV 50BV30;
- 3/8" (9.5 mm): E8, E10, E11, E12, E14, E16, E18, E20; CrV 6150;
- 1/2" (12.7 mm): (127, 254 mm), 3/8" (9.5 mm): (76, 152.4 mm), 1/4" (6.3 mm): (50.8 mm); CrV 50BV30;
- 1/2" (12.7 mm), 3/8" (9.5 mm), 1/4" (6.3 mm); CrV 50BV30;

- 3/8" (9.5 mm): 16, 21 mm; CrV 50BV30;
- 1/2" (12.7 mm): (255 mm), 3/8" (9.5 mm): (200 mm), 1/4" (6.3 mm): (155 mm); 72T; CrMo 440;
- 1/4" (6.3 mm): (150 mm); CrV 50BV30;
- 1/4" (6.3 mm) x 1/4" (6.3 mm); CrV 50BV30;
- 1/4" (6.3 mm): T10, T15, T20, T25, T27, T30, T40 (L=25 mm); AISI S2;
- 3/8" (9.5 mm): 4, 5.5, 6.5 mm (L=50 mm); AISI S2 / CrV 6150;
- 3/8" (9.5 mm): PH1, PH2, PH3 (L=50 mm); AISI S2 / CrV 6150;
- 3/8" (9.5 mm): PZ1, PZ2, PZ3 (L=50 mm); AISI S2 / CrV 6150;
- 3/8" (9.5 mm): T20, T30, T40, T45, T50, T55, T60 (L=50 mm); AISI S2 / CrV 6150;
- 3/8" (9.5 mm): 3, 4, 5, 6, 8, 10 mm (L=50 mm); AISI S2 / CrV 6150;
- 8, 9, 10, 11, 12, 13, 14, 15, 16, 17, 18, 19 mm; CrV;
- 8x10, 12x13, 17x19 mm; CrV 6140;
- 1.5, 2, 2.5, 3, 4, 5, 6, 7, 8, 10 mm; CrV 6150

YATO	○	☐
YT-38811	1/4" (6.3 mm), 3/8" (9.5 mm), 1/2" (12.7 mm)	2

EN Tool set
PL Zestaw narzędziowy
DE Werkzeug-Satz

RU Набор инструмента
CZ Sada nářadí
HU Szerszámkészlet

RO Trusa de scule
FR Jeu d'outils
IT Set di utensili

ES Juego de herramientas
CN 工具组套

173 PCS	1/2" 12.7mm	3/8" 9.5 mm	1/4" 6.3mm
CrV 50BV30	CrV 6150	CrV 40	CrMo 440
S2	72T	AS-DRIVE	

2



- 1/2" (12.7 mm): 10, 11, 12, 13, 14, 15, 16, 17, 18, 19, 20, 21, 22, 23, 24 mm (L=38 mm); 27, 30, 32 mm (L=42 mm), 3/8" (9.5 mm): 10, 11, 12, 13, 14, 15, 16 mm (L=28 mm); 17, 18, 19 mm (L=30 mm), 1/4" (6.3 mm): 4, 4.5, 5, 5.5, 6, 7, 8, 9, 10, 11, 12, 13, 14 mm (L=25 mm); CrV 50BV30;
- 1/2" (12.7 mm): 16, 17, 18, 19, 22 mm (L=76 mm), 3/8" (9.5 mm): 10, 11, 12, 13, 14, 15 mm (L=63 mm), 1/4" (6.3 mm): 4, 5, 6, 7, 8, 9, 10 mm (L=50 mm); CrV 50BV30;
- 1/2" (12.7 mm): E18, E20, E24, 3/8" (9.5 mm): E10, E11, E12, E14, E16, 1/4" (6.3 mm): E4, E5, E6, E7, E8; CrV 6150;
- 1/2" (12.7 mm): (127, 254 mm), 3/8" (9.5 mm): (152.4 mm), 1/4" (6.3 mm): (50.8, 101.6 mm); CrV 50BV30;
- 3/8" (9.5 mm) (F) x 1/2" (12.7 mm); CrV 50BV30;
- 1/2" (12.7 mm), 3/8" (9.5 mm), 1/4" (6.3 mm); CrV 50BV30;
- 1/2" (12.7 mm): 16, 21 mm, 3/8" (9.5 mm): 18 mm; CrV 50BV30;
- 1/4" (6.3 mm); (152.4 mm); CrV 40;
- 1/2" (12.7 mm); (255 mm), 3/8" (9.5 mm); (200 mm), 1/4" (6.3 mm); (155 mm); 72T; CrMo 440;
- 1/4" (6.3 mm); (150 mm); CrV 50BV30;
- 1/2" (12.7 mm) x 5/16" (7.9 mm), 3/8" (9.5 mm) x 5/16" (7.9 mm); CrV 50BV30;
- 1/4" (6.3 mm) x 1/4" (6.3 mm); CrV 50BV30;
- 5/16" (7.9 mm): 8, 10, 12 mm (L=30 mm); AISI S2;

- 5/16" (7.9 mm): PH3, PH4 (L=30 mm); AISI S2;
- 5/16" (7.9 mm): PZ3, PZ4 (L=30 mm); AISI S2;
- 5/16" (7.9 mm): T40, T45, T50, T55, T60, T70 (L=30 mm); AISI S2;
- 5/16" (7.9 mm): T40, T45, T50, T55, T60, T70 (L=30 mm); AISI S2;
- 5/16" (7.9 mm): 7, 8, 10, 12, 14 mm (L=30 mm); AISI S2;
- 1/4" (6.3 mm): T5, T6, T7 (L=25 mm); AISI S2;
- 1/4" (6.3 mm): T7, T10, T15, T20, T25, T27, T30, T40, T45 (L=25 mm); AISI S2;
- 1/4" (6.3 mm): M5, M6, M8 (L=25 mm); AISI S2;
- 1/4" (6.3 mm): RM5, RM6, RM7, RM8, RM9 (L=25 mm); AISI S2;
- 1/4" (6.3 mm) 4, 5.5, 6.5, 7 mm (L=37 mm); AISI S2 / CrV 6150;
- 1/4" (6.3 mm): PH0, PH1, PH2 (L=37 mm); AISI S2 / CrV 6150;
- 1/4" (6.3 mm) PZ0, PZ1, PZ2 (L=37 mm); AISI S2 / CrV 6150;
- 1/4" (6.3 mm): T8, T9, T10, T15, T20, T25, T27, T30 (L=37 mm); AISI S2 / CrV 6150;
- 1/4" (6.3 mm): T8, T9, T10, T15, T20, T25, T27, T30 (L=37 mm); AISI S2 / CrV 6150;
- 1/4" (6.3 mm): 3, 4, 5, 6 mm (L=37 mm); AISI S2 / CrV 6150;
- 1.25, 1.5, 2, 2.5, 3, 4, 5 mm; CrV 6150



YATO		
YT-38931	1/4" (6.3 mm), 3/8" (9.5 mm), 1/2" (12.7 mm)	2

EN Tool set
 PL Zestaw narzędziowy
 DE Werkzeug-Satz



















RU Набор инструмента
 CZ Sada nářadí
 HU Szerszámkészlet























RO Trusa de scule
 FR Jeu d'outils
 IT Set di utensili



ES Juego de herramientas
 CN 工具组套

216 PCS	1/2" 12.7mm	3/8" 9.5mm	1/4" 6.3mm
CrV 50BV30	CrV 6150	CrV 40	CrMo 440
S2	72T	AS-DRIVE	
			



-  1/2" (12.7 mm): 10, 11, 12, 13, 14, 15, 17, 19, 20, 21, 22, 24 mm (L=38 mm); 27, 30, 32 mm (L=42 mm);
- 3/8" (9.5 mm): 10, 11, 12, 13, 14, 15, 16 mm (L=28 mm); 17, 18, 19 mm (L=30 mm);
- 1/4" (6.3 mm): 4, 4.5, 5, 5.5, 6, 7, 8, 9, 10, 11, 12, 13, 14 mm (L=25 mm); CrV 50BV30;
-  1/2" (12.7 mm): 16, 17, 18, 19, 22 mm (L=76 mm); 3/8" (9.5 mm): 10, 11, 12, 13, 14, 15 mm (L=63 mm);
- 1/4" (6.3 mm): 4, 5, 6, 7, 8, 9, 10 mm (L=50 mm); CrV 50BV30;
-  1/2" (12.7 mm): E20, E22, E24, 3/8" (9.5 mm): E10, E11, E12, E14, E16, E18,
- 1/4" (6.3 mm): E4, E5, E6, E7, E8; CrV 50BV30;
-  1/2" (12.7 mm): (127, 254 mm); 3/8" (9.5 mm): (125 mm), 1/4" (6.3 mm): (50.8, 101.6 mm); CrV 50BV30;
-  1/2" (12.7 mm); 3/8" (9.5 mm), 1/4" (6.3 mm); CrV 50BV30;
-  1/2" (12.7 mm): 16, 21 mm; 3/8" (9.5 mm): 18 mm; CrV 50BV30;
-  1/2" (12.7 mm); (255 mm), 1/4" (6.3 mm); (152.4 mm); CrV 40;
-  1/2" (12.7 mm); (255 mm), 3/8" (9.5 mm); (200 mm), 1/4" (6.3 mm); (155 mm); 72T; CrMo 440;
-  1/4" (6.3 mm); (150 mm); CrV 50BV30;
-  1/4" (6.3 mm); (200 mm);
-  1/2" (12.7 mm) x 5/16" (7.9 mm), 3/8" (9.5 mm) x 5/16" (7.9 mm); CrV 50BV30;
-  1/4" (6.3 mm) x 1/4" (6.3 mm); CrV 50BV30;
-  5/16" (7.9 mm): 6, 6.5, 8 mm (L=30 mm); AISI S2;
-  5/16" (7.9 mm): PH3, PH4 (L=30 mm); AISI S2;
-  5/16" (7.9 mm): PZ3, PZ4 (L=30 mm); AISI S2;
-  5/16" (7.9 mm): T25, T27, T30, T35, T40 x2, T45, T50 (L=30 mm); AISI S2;
-  5/16" (7.9 mm): T27, T30, T35, T40, T45, T50 (L=30 mm); AISI S2;
-  5/16" (7.9 mm): 5.5, 6, 6.5, 7, 8 mm (L=30 mm); AISI S2;

-  5/16" (7.9 mm): M5, M6, M8, M10 (L=30 mm); AISI S2;
-  1/4" (6.3 mm): 4, 5.5, 6.5 mm (L=25 mm); AISI S2;
-  1/4" (6.3 mm): PH1, PH2 (L=25 mm); AISI S2;
-  1/4" (6.3 mm): PZ1, PZ2 (L=25 mm); AISI S2;
-  1/4" (6.3 mm): T8, T10, T15, T20, T25 (L=25 mm); AISI S2;
-  1/4" (6.3 mm): T8, T10 x2, T15 x2, T20 x2, T25 x2, T40 (L=25 mm); AISI S2;
-  1/4" (6.3 mm): 3, 4, 5, 6 mm (L=25 mm); AISI S2;
-  1/4" (6.3 mm): 3, 4, 5, 6 mm (L=25 mm); AISI S2;
-  1/4" (6.3 mm): M5, M6, M8 (L=25 mm); AISI S2;
-  1/4" (6.3 mm): S1, S2 (L=25 mm); AISI S2;
-  1/4" (6.3 mm): 1, 2, 3 mm (L=25 mm); AISI S2;
-  1/4" (6.3 mm): 6, 8, 10 mm (L=25 mm); AISI S2;
-  1/4" (6.3 mm): 4, 6, 8 mm (L=25 mm); AISI S2;
-  1/2" (12.7 mm): T55, T60 (L=50 mm); AISI S2 / CrV 50BV30;
-  1/4" (6.3 mm): 6, 6.5, 8 mm (L=37 mm); AISI S2 / CrV 50BV30;
-  1/4" (6.3 mm): PH3, PH4 (L=37 mm); AISI S2 / CrV 50BV30;
-  1/4" (6.3 mm): PZ3, PZ4 (L=37 mm); AISI S2 / CrV 50BV30;
-  1/4" (6.3 mm): T25, T27, T30, T35, T40 x2, T45, T50 (L=37 mm); AISI S2 / CrV 50BV30;
-  1/4" (6.3 mm): T27, T30, T35, T40, T45, T50 (L=37 mm); AISI S2 / CrV 50BV30;
-  1/4" (6.3 mm): 5.5, 6, 6.5, 7, 8 mm (L=37 mm); AISI S2 / CrV 50BV30;
-  1/4" (6.3 mm): M5, M6, M8, M10 (L=37 mm); AISI S2 / CrV 50BV30;
-  8, 10, 11, 12, 13, 14, 15, 16, 17, 18, 19, 22 mm; CrV;
-  1.27, 1.5, 2, 2.5, 3, 4, 5 mm; CrV 6150

YATO 		
YT-38841	1/4" (6.3 mm), 3/8" (9.5 mm), 1/2" (12.7 mm)	2

EN Tool set
PL Zestaw narzędziowy
DE Werkzeug-Satz

RU Набор инструмента
CZ Sada náradí
HU Szerszámkészlet

RO Trusa de scule
FR Jeu d'outils
IT Set di utensili

ES Juego de herramientas
CN 工具组套

225 PCS	1/2" 12.7mm	3/8" 9.5mm	1/4" 6.3mm
METRIC SAE	CrV 50BV30	CrV 6150	CrV 6140
CrV 40	CrMo 440	S2	72T
AS-DRIVE			



- 1/2" (12.7 mm): 10, 13, 15, 16, 17, 18, 19, 20, 21, 22, 23, 24 mm (L=38 mm); 27, 30, 32 mm (L=42 mm);
- 3/8" (9.5 mm): 10, 11, 12, 13, 14, 15, 16 mm (L=28 mm); 17, 18, 19 mm (L=30 mm);
- 1/4" (6.3 mm): 3.5, 4, 4.5, 5, 5.5, 6, 7, 8, 9, 10, 11, 12, 13, 14 mm (L=25 mm); CrV 50BV30;
- 1/2" (12.7 mm): 10, 11, 12, 13, 14, 15, 17, 19, 21 mm (L=76 mm);
- 3/8" (9.5 mm): 6, 7, 8, 9, 10 mm (L=63 mm); CrV 50BV30;
- 1/2" (12.7 mm) x 7/16" (11.1 mm), 1/2" (12.7 mm) x 1/2" (12.7 mm), 1/2" (12.7 mm) x 9/16" (14.3 mm),
- 1/2" (12.7 mm) x 5/8" (15.9 mm), 1/2" (12.7 mm) x 11/16" (17.5 mm), 1/2" (12.7 mm) x 3/4" (19.0 mm),
- 1/2" (12.7 mm) x 13/16" (20.6 mm), 1/2" (12.7 mm) x 7/8" (22.2 mm), 1/4" (6.3 mm) x 1/4" (6.3 mm),
- 1/4" (6.3 mm) x 9/32" (7.1 mm), 1/4" (6.3 mm) x 5/16" (7.9 mm), 1/4" (6.3 mm) x 11/32" (8.7 mm),
- 1/4" (6.3 mm) x 3/8" (9.5 mm); CrV 50BV30;
- 1/2" (12.7 mm): 17, 19, 21 mm; CrV 50BV30;
- 1/2" (12.7 mm): E16, E18, E20, E22, E24, 3/8" (9.5 mm): E10, E11, E12, E14,
- 1/4" (6.3 mm): E4, E5, E6, E7, E8; CrV 6150;
- 1/2" (12.7 mm): (127, 254 mm), 3/8" (9.5 mm): (76, 254 mm), 1/4" (6.3 mm): (50.8, 101.6 mm); CrV 50BV30;
- 3/8" (9.5 mm) (F) x 1/2" (12.7 mm) (M), 1/2" (12.7 mm) (F) x 3/8" (9.5 mm) (M); CrV 50BV30;
- 1/2" (12.7 mm), 3/8" (9.5 mm), 1/4" (6.3 mm); CrV 50BV30;
- 1/2" (12.7 mm): 16, 21 mm (L=64 mm); 3/8" (9.5 mm): 18 mm (L=63 mm); CrV 50BV30;
- 1/4" (6.3 mm): (152.4 mm); CrV 40;
- 1/2" (12.7 mm); (255 mm), 3/8" (9.5 mm); (200 mm), 1/4" (6.3 mm); (155 mm); 72T; CrMo 440;
- 1/4" (6.3 mm); (150 mm); CrV 50BV30;
- 1/4" (6.3 mm); (200 mm); CrV 6140;
- 1/2" (12.7 mm) x 5/16" (7.9 mm), 3/8" (9.5 mm) x 5/16" (7.9 mm), 3/8" (9.5 mm) x 1/4" (6.3 mm); CrV 50BV30;
- 1/4" (6.3 mm) x 1/4" (6.3 mm); CrV 50BV30;
- 1/4" (6.3 mm) x 3/8" (9.5 mm) (L=50 mm), 1/4" (6.3 mm) x 1/4" (6.3 mm) (L=50 mm), 1/4" (6.3 mm) x 1/4"

- (6.3mm) (L=25 mm); CrV 50BV30;
- 1/4" (6.3 mm) (L=60 mm);
- 5/16" (7.9 mm): T20, T25, T27, T30, T40, T45, T50, T55 (L=75 mm); AISI S2;
- 5/16" (7.9 mm): 8, 10 mm (L=30 mm); AISI S2;
- 5/16" (7.9 mm): PH3, PH4 (L=30 mm); AISI S2;
- 5/16" (7.9 mm): PZ3, PZ4 (L=30 mm); AISI S2;
- 5/16" (7.9 mm): T40, T45, T50, T55, T60, T70 (L=30 mm); AISI S2;
- 5/16" (7.9 mm): T40, T45, T50, T55, T60, T70 (L=30 mm); AISI S2;
- 5/16" (7.9 mm): 10, 12, 14 mm (L=30 mm); AISI S2;
- 1/4" (6.3 mm): 3, 4, 5.5, 6.5, 7, 8, 9 mm (L=25 mm); AISI S2;
- 1/4" (6.3 mm): PH0, PH1, PH2, PH3 (L=25 mm); AISI S2;
- 1/4" (6.3 mm): PZ0, PZ1, PZ2, PZ3 (L=25 mm); AISI S2;
- 1/4" (6.3 mm): T8, T9, T10, T15, T20, T25, T27, T30 (L=25 mm); AISI S2;
- 1/4" (6.3 mm): T8, T9, T10, T15, T20, T25, T27, T30 (L=25 mm); AISI S2;
- 1/4" (6.3 mm): 3, 4, 5, 6, 7, 8 mm; (L=25 mm); AISI S2;
- 1/4" (6.3 mm): 3, 4, 5, 6, 7, 8 mm (L=25 mm); AISI S2;
- 1/4" (6.3 mm): 4, 5, 6, 7, 8 mm (L=25 mm); AISI S2;
- 1/4" (6.3 mm): 1, 2, 3, 4 (L=25 mm); AISI S2;
- 1/4" (6.3 mm): 6, 8, 10 (L=25 mm); AISI S2;
- 1/4" (6.3 mm): 4, 6, 8, 10 mm (L=25 mm); AISI S2;
- 8, 9, 10, 11, 12, 13, 14, 15, 17, 19, 22 mm; CrV;
- 6x38, PH2X38; S2;
- 180 mm;
- 250 mm; CrV;
- 2, 2.5, 3, 4, 5, 6, 7, 8, 10, 12 mm; CrV 6150

YATO		
YT-38941	1/4" (6.3 mm), 3/8" (9.5 mm), 1/2" (12.7 mm)	2

EN Tool set
PL Zestaw narzędziowy
DE Werkzeug-Satz

RU Набор инструмента
CZ Sada nářadí
HU Szerszámkészlet

RO Trusa de scule
FR Jeu d'outils
IT Set di utensili

ES Juego de herramientas
CN 工具组套

23 PCS
1/4" 6.3mm
CrV 50BV30

CrV 6140
72T
AS-DRIVE



- 1/4" (6.3 mm): 4, 5, 6, 7, 8, 9, 10, 12, 13 mm (L=25 mm); CrV 50BV30;
- 1/4" (6.3 mm): 4, 5, 6, 7, 8, 9, 10, 12, 13 mm (L=50 mm); CrV 50BV30;
- 1/4" (6.3 mm): (50.8, 152.4 mm); CrV 50BV30;
- 1/4" (6.3 mm); CrV 50BV30;
- 1/4" (6.3 mm); (127 mm); 72T; CrV 6140;
- 1/4" (6.3 mm); (150 mm); CrV 50BV30

YATO	○	
YT-14421	1/4" (6.3 mm)	10

EN Go through socket set
PL Zestaw nasadek przelotowych z grzechotką
DE Ratschensteckschlüsselsatz

RU Набор проходных головок с трещоткой
CZ Sada násadových koncovek s ráčnou
HU Dugókulcs készlet racsníval

RO Set tubulare pt. suruburi lungi
FR Jeu de douilles traversantes avec cliquet
IT Set di bussole con chiave a cricchetto

ES Juego de puntas de paso de trinqueta
CN 穿心套筒组套

29 PCS
1/4" 6.3mm

CrV 50BV30
S2
72T

QUICK RELEASE SZYBKO-ZŁACZE



- 4, 5, 5.5, 6, 7, 8, 9, 10, 11, 12, 13 mm; CrV 50BV30;
- 1/4" (6.3 mm); (L=100 mm); CrV 50BV30;
- 1/4" (6.3 mm); CrV 50BV30;
- (L=142 mm); 72T; CrV 50BV30;
- 1/4" (6.3 mm); CrV 50BV30;
- 1/4" (6.3 mm); CrV 50BV30;
- 1/4" (6.3 mm) x 1/4" (6.3 mm); CrV 50BV30;
- 1/4" (6.3 mm); CrV 50BV30;
- (L=50 mm); CrV 50BV30;
- 1/4" (6.3 mm); 4, 5, 7 mm; S2;
- 1/4" (6.3 mm); PH1, PH2; S2;
- 1/4" (6.3 mm); PZ1, PZ2; S2;
- 1/4" (6.3 mm); T10, T15, T20; S2

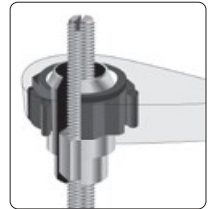

YATO	○	
YT-38650	1/4" (6.3 mm)	20

EN Tool set
PL Zestaw narzędziowy
DE Werkzeug-Satz

RU Набор инструмента
CZ Sada nářadí
HU Szerszámkészlet

RO Trusa de scule
FR Jeu d'outils
IT Set di utensili

ES Juego de herramientas
CN 工具组套

25 PCS
1/2" 12.7mm
CrV 50BV30

CrV 6140
72T
AS-DRIVE



- 1/2" (12.7 mm): 10, 11, 12, 13, 14, 15, 16, 17, 18, 19, 20, 21, 22, 23, 24 mm (L=38 mm); 27, 30, 32 mm (L=42 mm); CrV 50BV30;
- 1/2" (12.7 mm); (50, 125 mm); CrV 50BV30;
- 1/2" (12.7 mm): 16, 21 mm; CrV 50BV30;
- 1/2" (12.7 mm); (250 mm); CrV 50BV30;
- 1/2" (12.7 mm); (250 mm); 72T; CrV 6140;
- 1/2" (12.7 mm); (317 mm); CrV 50BV30

YATO	○	
YT-12671	1/2" (12.7 mm)	5

EN Go through socket set
PL Zestaw nasadek przelotowych z grzechotką
DE Ratschensteckschlüsselsatz

RU Набор проходных головок с трещоткой
CZ Sada násadových koncovek s ráčnou
HU Dugókulcs készlet racsníval

RO Set tubulare pt. suruburi lungi
FR Jeu de douilles traversantes avec cliquet
IT Set di bussole con chiave a cricchetto

ES Juego de puntas de paso de trinqueta
CN 穿心套筒组套

17 PCS
1/2" 12.7mm
3/8" 9.5mm
CrV 50BV30
72T
QUICK RELEASE SZYBKO-ZŁACZE



- 10, 11, 12, 13, 14, 15, 16, 17, 18, 19, 21, 22, 24 mm; CrV 50BV30;
- (L=195 mm); 72T; CrV 50BV30;
- (L=76 mm); CrV 50BV30;
- 1/2" (12.7 mm); 3/8" (9.5 mm); CrV 50BV30

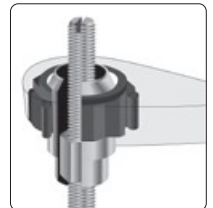

YATO	○	
YT-38653	3/8" (9.5 mm), 1/2" (12.7 mm)	10

EN Tool set
PL Zestaw narzędziowy
DE Werkzeug-Satz
RU Набор инструмента
CZ Sada nářadí
HU Szerszámkészlet

RO Trusa de scule
FR Jeu d'outils
IT Set di utensili
ES Juego de herramientas
CN 工具组套

44
PCS

1/4"
6.3mm

⊖ ⊕ ⊛ ⊚

CrV S2 SK2



- ⌀ 6x7, 8x9, 10x11, 12x13, 14x15 mm;
- ⌀ 1/4" (6.3 mm): 3, 4, 5, 5.5, 6 mm (L=25 mm); AISI S2;
- ⊕ 1/4" (6.3 mm): PH1, PH2, PH3 (L=25 mm); AISI S2;
- ⊛ 1/4" (6.3 mm): T8, T10, T15, T20, T25, T27 (L=25 mm); AISI S2;
- ⊚ 1/4" (6.3 mm): 2, 2.5, 3, 4, 5, 6 mm (L=25 mm); AISI S2;
- 160 mm;
- 160 mm;
- 200 mm;
- 300 g (L=300 mm);
- 3 m x 16 mm;
- 18 mm; SK2;
- 1/4" (6.3 mm); CrV;
- 5x75, 6x100, PH2x100 mm; S2;
- 1.5, 2, 2.5, 3, 4, 5, 6, 8, 10 mm; CrV 6150

EN Torx socket
PL Nasadka Torx
DE Torx-Steckschlüssel
RU Головка
CZ Nástavec Torx
HU Dugókulcs Torx
RO Cheie tubulară Torx
FR Douille Torx
IT Bullone Torx
ES Boquilla Torx
CN 星型套筒

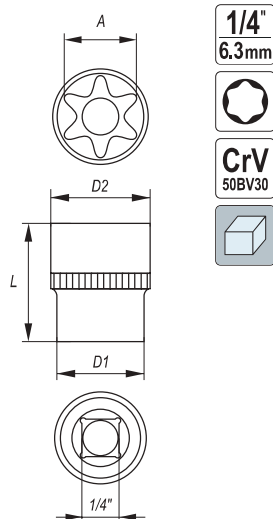

YATO	⊛ A	D1 [mm]	D2 [mm]	L [mm]	PCS	FOUR
YT-05211	E4	11.9	6.7	25	24	240/480
YT-05212	E5	11.9	7.2	25	24	240/480
YT-05213	E6	11.9	8.3	25	24	240/480
YT-05214	E7	11.9	9.4	25	24	240/480
YT-05215	E8	11.9	10	25	24	240/480

YATO ⊚
YT-39280 1/4" (6.3 mm) 4

EN Torx socket
PL Nasadka Torx
DE Torx-Steckschlüssel
RU Головка
CZ Nástavec Torx
HU Dugókulcs Torx
RO Cheie tubulară Torx
FR Douille Torx
IT Bullone Torx
ES Boquilla Torx
CN 星型套筒

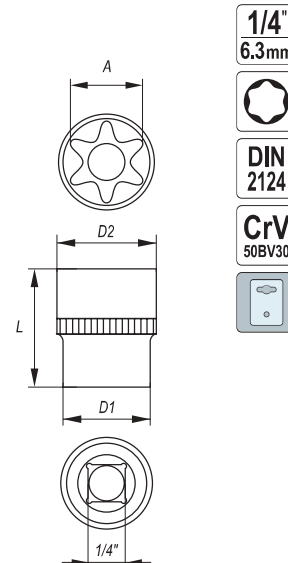

YATO	⊛ A	D1 [mm]	D2 [mm]	L [mm]	PCS
YT-05244	E8	11.9	10	25	6/360



- EN Torx socket set
- PL Klucze nasadowe Torx
- DE Torx-Steckschlüsselsatz
- RU Набор ронцов
- CZ Nástrčné klíče
- HU Dugókulcsok Torx
- RO Trusa tubulară
- FR Clés à tube
- IT Chiavi a bussola bulloni Torx
- ES Llaves de vaso
- CN 星型套筒组套

9 PCS

1/4"
6.3mm

3/8"
9.5mm

CrV
50BV30

1/4" (6.3 mm): E5, E6, E7, E8, 3/8" (9.5 mm): E10, E12, E14, E16;
1/4" (6.3 mm) (M) x 3/8" (9.5 mm) (F)

YATO	Ø A	PCS
YT-0520	1/4" (6.3 mm)	10/40



- EN Torx socket
- PL Nasadka Torx
- DE Torx-Steckschlüssel
- RU Головка
- CZ Nástavec Torx
- HU Dugókulcs Torx
- RO Cheie tubulară Torx
- FR Douille Torx
- IT Bullone Torx
- ES Boquilla Torx
- CN 星型套筒



1/2"
12.7mm

DIN
2124

CrV
50BV30

YATO	Ø A	D1 [mm]	D2 [mm]	L [mm]	PCS
YT-05245	E10	21.8	13.1	38	6/180
YT-05246	E11	21.8	13.9	38	6/180
YT-05247	E12	21.8	14.9	38	6/180
YT-05248	E14	21.8	16.3	38	6/180
YT-05249	E16	21.8	18.2	38	6/180
YT-05250	E18	23.8	19.4	38	6/180
YT-05251	E20	21.8	23.9	38	6/180

- EN Hexagonal socket
- PL Nasadka sześciokątna
- DE Sechskantenschlüssel
- RU Головка шестигранная короткая
- CZ Šestihranný nástavec
- HU Dugókulcs hatszög
- RO Cheie tubulară hexagonală
- FR Douille courte
- IT Chiave a bussola esagonale
- ES Boquilla hexagonal corta
- CN 六角套筒



- Application: industry, car service stations and workshops
- For high loads
- Drive locks
- Surface finish: chromed, satin
- Przeznaczenie: przemysł, serwisy i warsztaty
- Do największych obciążeń
- Zamki blokujące
- Wykończenie powierzchni: chromowana, satynowa

YATO	Ø A [mm]	D1 [mm]	D2 [mm]	L [mm]	PCS
YT-1301	19	30	36	50	12 96
YT-1302	21	32	36	50	12 96
YT-1303	22	32	36	50	12 96
YT-1304	23	34	36	50	12 96
YT-1305	24	34	36	50	12 96
YT-1306	25	36	36	50	12 96
YT-1307	26	37	34	50	12 96
YT-1308	27	38	34	50	12 96
YT-1309	28	40	34	50	12 96
YT-1310	29	40	35	50	12 96
YT-1311	30	42	36	55	8 48
YT-1312	32	44	37	55	8 48
YT-1313	33	46	38	55	8 48

- EN Torx socket
- PL Nasadka Torx
- DE Torx-Steckschlüssel
- RU Головка
- CZ Nástavec Torx
- HU Dugókulcs Torx
- RO Cheie tubulară Torx
- FR Douille Torx
- IT Bullone Torx
- ES Boquilla Torx
- CN 星型套筒



1/2"
12.7mm

CrV
50BV30







YATO	Ø A	D1 [mm]	D2 [mm]	L [mm]	PCS
YT-05220	E10	21.8	13.1	38	12 120/240
YT-05221	E11	21.8	13.9	38	12 120/240
YT-05222	E12	21.8	14.9	38	12 120/240
YT-05223	E14	21.8	16.3	38	12 120/240
YT-05224	E16	21.8	18.2	38	12 120/240
YT-05225	E18	23.8	19.4	38	12 120/240
YT-05226	E20	21.8	23.9	38	12 120/240
YT-05227	E22	23.2	25.7	38	12 120/240
YT-05228	E24	23.8	27.8	38	12 60/120

- EN Torx socket set
- PL Klucze nasadowe Torx
- DE Torx-Steckschlüsselsatz
- RU Набор ронцов
- CZ Nástrčné klíče
- HU Dugókulcsok Torx
- RO Trusa tubulară
- FR Clés à tube
- IT Chiavi a bussola bulloni Torx
- ES Llaves de vaso
- CN 星型套筒组套

9 PCS

1/2"
12.7mm

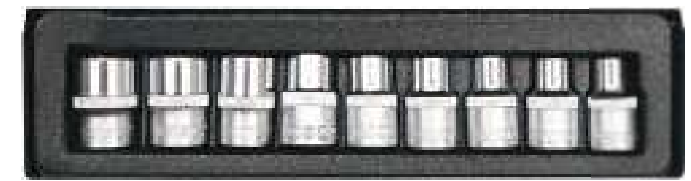
CrV
50BV30

1/2" (12.7 mm): E10, E11, E12, E14, E16, E18, E20, E22, E24

YATO	Ø A	PCS
YT-0521	1/2" (12.7 mm)	20

3/4"
19mm

DIN
3121

CrV
50BV30

AS-DRIVE

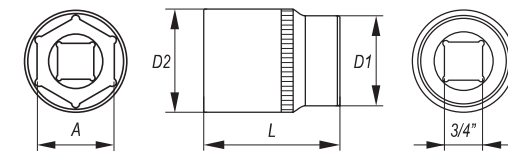



YATO	Ø A [mm]	D1 [mm]	D2 [mm]	L [mm]	PCS
YT-1314	34	47	38	55	8 48
YT-1315	35	48	42	60	6 36
YT-1316	36	50	42	60	6 36
YT-1317	38	52	45	60	6 36
YT-1318	41	56	45	65	4 32
YT-1319	42	57	45	65	4 32
YT-1320	43	58	45	65	4 32
YT-1322	46	62	48	70	4 32
YT-1323	48	64	48	70	4 24
YT-1324	50	68	48	70	4 24
YT-1326	52	70	48	70	4 20
YT-1328	55	73	48	75	4 20
YT-1330	60	80	48	80	4 20

- EN Extension bar
- PL Przedłużka
- DE Verlängerung
- RU Удлинитель для воротка
- CZ Prodlužovací přípravek
- HU Toldalék
- RO Prelungitor
- FR Rallonge
- IT Prolunga
- ES Tubo de prolongación
- CN 接杆

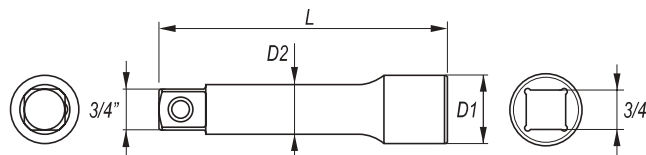

3/4" 19mm
DIN 3121
CrV 50BV30



YATO	Ø	D1 [mm]	D2 [mm]	L [mm]	PCS RODIE	☐
YT-1340	3/4" (19.0 mm)	36	22	100	6	36
YT-1341	3/4" (19.0 mm)	36	22	200	5	20
YT-1342	3/4" (19.0 mm)	36	22	400	5	10

- EN Adapter
- PL Redukcja
- DE Reduktion
- RU Переходник
- CZ Redukce
- HU Redukció
- RO Reducție
- FR Réduction
- IT Riduttore
- ES Reducción
- CN 转换头

3/4" 19mm
DIN 3121
CrV 50BV30

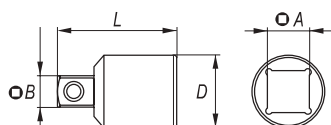

YATO	ØA	ØB	D [mm]	L [mm]	PCS RODIE	☐
YT-1355	3/4" (19.0 mm) (F)	1/2" (12.7 mm) (M)	36	53	12	48

- EN Sliding T-bar
- PL Pokrętko typu „T”
- DE Handgriff mit Gleitstück
- RU Вороток Т-образный
- CZ Otočná ráčka typ „T”
- HU „T” alakú hajtókar
- RO Mâner clupă tipul „T”
- FR Barre type „T”
- IT Manopola „T” scorrevole
- ES Mango tipo „T”
- CN 滑杆

3/4" 19mm
DIN 3121
CrV 50BV30

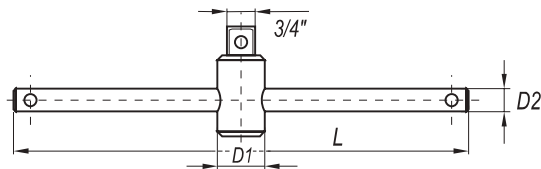

YATO	Ø	D1 [mm]	D2 [mm]	L [mm]	PCS RODIE	☐
YT-1350	3/4" (19.0 mm)	37	20	500	5	10

- EN Flexible handle
- PL Pokrętko łamane
- DE Gelenkgriff
- RU Вороток шарнирный
- CZ Otočná lomená ráčka
- HU Hajlított hajtókar
- RO Prelungitor cu prindere flexibilă
- FR Barre pivotante
- IT Manopola a snodo
- ES Mango articulado
- CN 转向手柄

3/4" 19mm
DIN 3121
CrV 50BV30

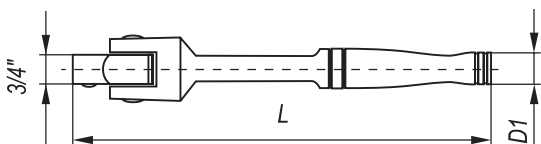

YATO	Ø	D [mm]	L [mm]	PCS RODIE	☐
YT-1345	3/4" (19.0 mm)	25	507	5	10

- EN L-type handle
- PL Pokrętko typu „L”
- DE Admüternschlüssel
- RU Вороток тип „L”
- CZ Páka zahnutá
- HU „L” alakú hajtókar
- RO Măner clupă tipul „L”
- FR Barre type „L”
- IT Leva tipo „L”
- ES Mango tipo „L”
- CN L型扳手

3/4"
19mm

DIN
3121

CrV
50BV30



- EN L-type handle
- PL Pokrętko typu „L”
- DE Admüternschlüssel
- RU Вороток тип „L”
- CZ Páka zahnutá
- HU „L” alakú hajtókar
- RO Măner clupă tipul „L”
- FR Barre type „L”
- IT Leva tipo „L”
- ES Mango tipo „L”
- CN L型扳手

3/4"
19mm

DIN
3122

CrV
50BV30

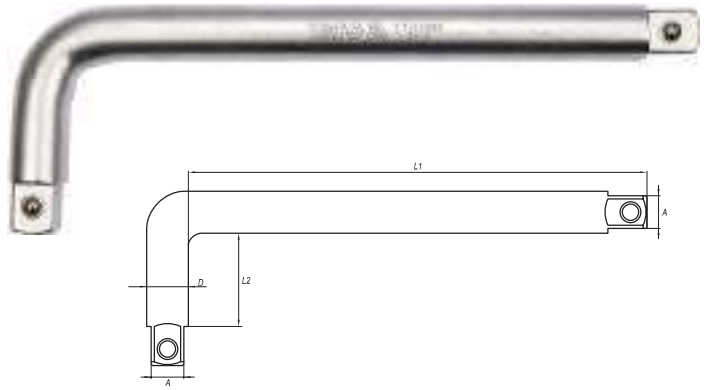
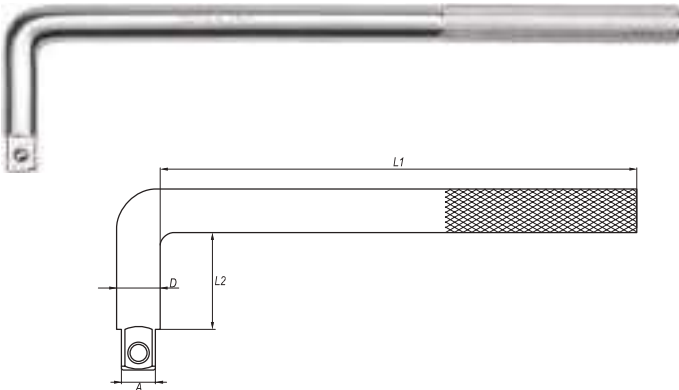
YATO	Ø	D [mm]	L1 [mm]	L2 [mm]	PCS ROZET	
YT-1347	3/4" (19.0 mm)	25	360	75	5	10
YT-1348	3/4" (19.0 mm)	25	410	75	5	10

YATO	Ø	D [mm]	L1 [mm]	L2 [mm]	
YT-13465	3/4" (19.0 mm)	25	275	75	2/12
YT-13475	3/4" (19.0 mm)	25	373	75	2/8
YT-13490	3/4" (19.0 mm)	25	578	75	2/8

- EN Quick release ratchet handle
- PL Grzechotka
- DE Hebelumschaltknarre
- RU Трещотка
- CZ Ráčna
- HU Racsnis hajtókar
- RO Dispozitiv de prindere cu clichet
- FR Clé à cliquet
- IT Cricchetto bussola
- ES Carraca
- CN 快速脱落棘轮扳手



3/4"
19mm

DIN
3112

**QUICK
RELEASE
SZYBKO-
ZŁĄCZE**

24T

CrV
6140



YATO	Ø	T	L [mm]	
YT-1360	3/4" (19.0 mm)	24	615	10

- EN Tool set
- PL Zestaw narzędziowy
- DE Werkzeug-Satz
- RU Набор инструмента
- CZ Sada nářadí
- HU Szerszámkészlet
- RO Trusa de scule
- FR Jeu d'outils
- IT Set di utensili
- ES Juego de herramientas
- CN 工具组套



15
PCS

3/4"
19mm

CrV
50BV30

CrV
6140

**QUICK
RELEASE
SZYBKO-
ZŁĄCZE**

24T

AS-DRIVE



- 3/4" (19.0 mm); 30, 32, 34 (L=55 mm); 36, 38 (L=60 mm); 41 (L=65 mm); 46, 50 (L=70 mm); 55 (L=75 mm); 60 mm (L=80 mm); CrV 50BV30;
- 3/4" (19.0 mm); (L=100, 200 mm); CrV 50BV30;
- 3/4" (19.0 mm); (L=106 mm); CrV 50BV30;
- 3/4" (19.0 mm); (L=500 mm); CrV 50BV30;
- 3/4" (19.0 mm); (L=500 mm); 24T; CrV 6140

YATO	Ø	
YT-1334	3/4" (19.0 mm)	1

- EN Tool set
- PL Zestaw narzędziowy
- DE Werkzeug-Satz
- RU Набор инструмента
- CZ Sada nářadí
- HU Szerszámkészlet
- RO Trusa de scule
- FR Jeu d'outils
- IT Set di utensili
- ES Juego de herramientas
- CN 工具组套



20
PCS

3/4"
19mm

CrV
50BV30

CrV
6140

**QUICK
RELEASE
SZYBKO-
ZŁĄCZE**

24T

AS-DRIVE



- 3/4" (19.0 mm); 19, 21, 22, 24 mm (L=50 mm); 26, 27, 28 mm (L=52 mm); 30, 32 mm (L=53 mm); 33, 34 mm (L=56 mm); 36 mm (L=58 mm); 38 mm (L=60 mm); 41 mm (L=64 mm); 46 mm (L=68 mm); 50 mm (L=72mm); CrV 50BV30;
- 3/4" (19.0 mm); (L=100, 200 mm); CrV 50BV30;
- 3/4" (19.0 mm); (L=500 mm); CrV 50BV30;
- 3/4" (19.0 mm); (L=620 mm); CrV 6140

YATO	Ø	
YT-1335	3/4" (19.0 mm)	1

EN Bit socket
PL Klucz trzpieniowy
DE Bit-Stecknuss
RU Головка торцевая с вставкой
CZ Hlavice s bitem
HU Csapkulcs
RO Chei cu cozi
FR Douille tournevis
IT Chiavi a bussola a giravite
ES Llave de mandril
CN 星型旋具套筒

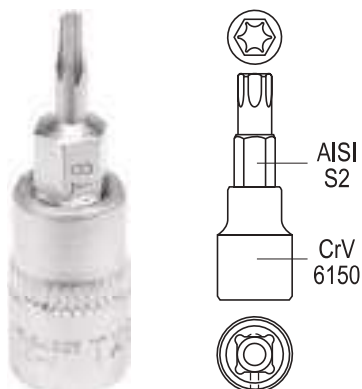

YATO	Ø	⊕	L [mm]	[Nm]	📦
YT-04301	1/4" (6.3 mm)	T8	37	2.6	150/600
YT-04302	1/4" (6.3 mm)	T10	37	4.6	150/600
YT-04303	1/4" (6.3 mm)	T15	37	7.7	150/600
YT-04304	1/4" (6.3 mm)	T20	37	12.7	150/600
YT-04305	1/4" (6.3 mm)	T25	37	19.0	150/600
YT-04306	1/4" (6.3 mm)	T30	37	37.4	150/600
YT-04307	1/4" (6.3 mm)	T40	37	65.0	150/600

EN Bit socket
PL Klucz trzpieniowy
DE Bit-Stecknuss
RU Головка торцевая с вставкой
CZ Hlavice s bitem
HU Csapkulcs
RO Chei cu cozi
FR Douille tournevis
IT Chiavi a bussola a giravite
ES Llave de mandril
CN 六角旋具套筒

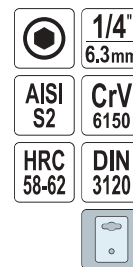

YATO	Ø	⊙ [mm]	L [mm]	[Nm]	📦
YT-04370	1/4" (6.3 mm)	3	37	6.6	150/600
YT-04371	1/4" (6.3 mm)	4	37	16.0	150/600
YT-04372	1/4" (6.3 mm)	5	37	30.0	150/600
YT-04373	1/4" (6.3 mm)	6	37	52.2	150/600
YT-04374	1/4" (6.3 mm)	7	37	78.0	150/600
YT-04375	1/4" (6.3 mm)	8	37	120.0	150/600

EN Bit socket
PL Klucz trzpieniowy
DE Bit-Stecknuss
RU Головка торцевая с вставкой
CZ Hlavice s bitem
HU Csapkulcs
RO Chei cu cozi
FR Douille tournevis
IT Chiavi a bussola a giravite
ES Llave de mandril
CN 十字旋具套筒

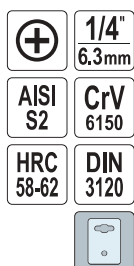

YATO	Ø	⊕	L [mm]	[Nm]	📦
YT-04411	1/4" (6.3 mm)	PH1	37	3.5	150/600
YT-04412	1/4" (6.3 mm)	PH2	37	8.2	150/600
YT-04413	1/4" (6.3 mm)	PH3	37	19.5	150/600

EN Bit socket
PL Klucz trzpieniowy
DE Bit-Stecknuss
RU Головка торцевая с вставкой
CZ Hlavice s bitem
HU Csapkulcs
RO Chei cu cozi
FR Douille tournevis
IT Chiavi a bussola a giravite
ES Llave de mandril
CN 十字旋具套筒

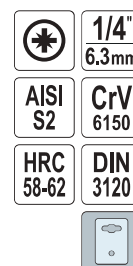

YATO	Ø	⊕	L [mm]	[Nm]	📦
YT-04417	1/4" (6.3 mm)	PZ1	37	3.5	150/600
YT-04418	1/4" (6.3 mm)	PZ2	37	8.2	150/600

EN Bit socket
 PL Klucz trzpieniowy
 DE Bit-Stecknuss
 RU Головка торцевая с вставкой
 CZ Hlavice s bitem
 HU Csapkulcs
 RO Chei cu cozi
 FR Douille tournevis
 IT Chiavi a bussola a giravite
 ES Llave de mandril
 CN 六角旋具套筒

1/2" 12.7mm
 AISI S2 CrV 6150
 HRC 58-62 DIN 3120



EN Bit socket
 PL Klucz trzpieniowy
 DE Bit-Stecknuss
 RU Головка торцевая с вставкой
 CZ Hlavice s bitem
 HU Csapkulcs
 RO Chei cu cozi
 FR Douille tournevis
 IT Chiavi a bussola a giravite
 ES Llave de mandril
 CN 十二角旋具套筒

1/2" 12.7mm
 AISI S2 CrV 6150
 HRC 58-62 DIN 3120



YATO	Ø	◎ [mm]	L [mm]	[Nm]	
YT-04381	1/2" (12.7 mm)	5	55	30	40/240
YT-04382	1/2" (12.7 mm)	6	55	52	40/240
YT-04383	1/2" (12.7 mm)	7	55	78	40/240
YT-04384	1/2" (12.7 mm)	8	55	120	40/240
YT-04385	1/2" (12.7 mm)	10	55	220	40/160
YT-04386	1/2" (12.7 mm)	12	55	370	40/160
YT-04387	1/2" (12.7 mm)	14	55	590	40/160
YT-04388	1/2" (12.7 mm)	17	55	1000	40/160

YATO	Ø	◎	L [mm]	[Nm]	
YT-04341	1/2" (12.7 mm)	M6	55	30	40/240
YT-04342	1/2" (12.7 mm)	M8	55	52	40/240
YT-04343	1/2" (12.7 mm)	M10	55	120	40/160
YT-04344	1/2" (12.7 mm)	M12	55	220	40/160
YT-04345	1/2" (12.7 mm)	M14	55	370	40/160
YT-04346	1/2" (12.7 mm)	M16	55	590	40/160

EN Bit socket
 PL Klucz trzpieniowy
 DE Bit-Stecknuss
 RU Головка торцевая с вставкой
 CZ Hlavice s bitem
 HU Csapkulcs
 RO Chei cu cozi
 FR Douille tournevis
 IT Chiavi a bussola a giravite
 ES Llave de mandril
 CN 星型旋具套筒

1/2" 12.7mm
 AISI S2 CrV 6150
 HRC 58-62 DIN 3120



EN Bit socket
 PL Klucz trzpieniowy
 DE Bit-Stecknuss
 RU Головка торцевая с вставкой
 CZ Hlavice s bitem
 HU Csapkulcs
 RO Chei cu cozi
 FR Douille tournevis
 IT Chiavi a bussola a giravite
 ES Llave de mandril
 CN 六角旋具套筒

1/2" 12.7mm
 AISI S2 CrV 6150
 HRC 58-62 DIN 3120

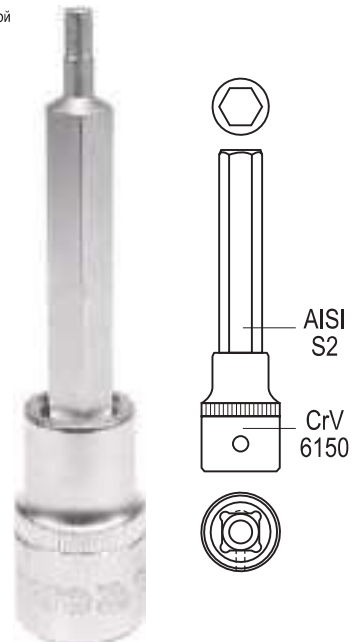

YATO	Ø	◎	L [mm]	[Nm]	
YT-04310	1/2" (12.7 mm)	T20	55	12.7	40/240
YT-04311	1/2" (12.7 mm)	T25	55	19.0	40/240
YT-04312	1/2" (12.7 mm)	T27	55	27.0	40/240
YT-04313	1/2" (12.7 mm)	T30	55	37.4	40/240
YT-04314	1/2" (12.7 mm)	T40	55	65.0	40/240
YT-04315	1/2" (12.7 mm)	T45	55	103.5	40/240
YT-04316	1/2" (12.7 mm)	T50	55	159.0	40/240
YT-04317	1/2" (12.7 mm)	T55	55	257.0	40/240
YT-04318	1/2" (12.7 mm)	T60	55	445.0	40/160
YT-04319	1/2" (12.7 mm)	T70	55	700.0	40/160

YATO	Ø	◎ [mm]	L [mm]	[Nm]	
YT-04390	1/2" (12.7 mm)	4	100	16	20/120
YT-04391	1/2" (12.7 mm)	5	100	30	20/120
YT-04392	1/2" (12.7 mm)	6	100	52	20/120
YT-04393	1/2" (12.7 mm)	7	100	78	20/120
YT-04394	1/2" (12.7 mm)	8	100	120	20/120
YT-04395	1/2" (12.7 mm)	10	100	220	20/120
YT-04396	1/2" (12.7 mm)	12	100	370	20/120
YT-04397	1/2" (12.7 mm)	14	100	590	20/120
YT-04398	1/2" (12.7 mm)	17	100	1000	20/120

EN Bit socket
PL Klucz trzpieniowy
DE Bit-Stecknuss
RU Головка торцевая с вставкой
CZ Hlavice s bitem
HU Csapkulcs
RO Chei cu cozi
FR Douille tournevis
IT Chiavi a bussola a giravite
ES Llave de mandril
CN 星型旋具套筒

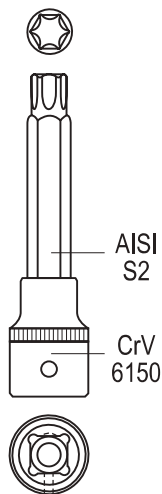

1/2"
12.7mm
AISI S2
CrV 6150
HRC 58-62
DIN 3120

EN Bit socket
PL Klucz trzpieniowy
DE Bit-Stecknuss
RU Головка торцевая с вставкой
CZ Hlavice s bitem
HU Csapkulcs
RO Chei cu cozi
FR Douille tournevis
IT Chiavi a bussola a giravite
ES Llave de mandril
CN 十二角旋具套筒

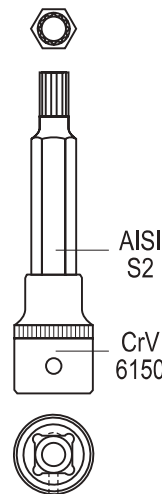

1/2"
12.7mm
AISI S2
CrV 6150
HRC 58-62
DIN 3120

YATO	Ø	⊙	L [mm]	[Nm]	☐
YT-04320	1/2" (12.7 mm)	T20	100	12.7	20/120
YT-04321	1/2" (12.7 mm)	T25	100	19.0	20/120
YT-04322	1/2" (12.7 mm)	T27	100	27.0	20/120
YT-04323	1/2" (12.7 mm)	T30	100	37.4	20/120
YT-04324	1/2" (12.7 mm)	T40	100	65.0	20/120
YT-04325	1/2" (12.7 mm)	T45	100	103.5	20/120
YT-04326	1/2" (12.7 mm)	T50	100	159.0	20/120
YT-04327	1/2" (12.7 mm)	T55	100	257.0	20/120
YT-04328	1/2" (12.7 mm)	T60	100	445.0	20/120
YT-04329	1/2" (12.7 mm)	T70	100	700.0	20/120

YATO	Ø	⊙	L [mm]	[Nm]	☐
YT-04350	1/2" (12.7 mm)	M5	100	16	20/120
YT-04351	1/2" (12.7 mm)	M6	100	30	20/120
YT-04352	1/2" (12.7 mm)	M8	100	52	20/120
YT-04353	1/2" (12.7 mm)	M10	100	120	20/120
YT-04354	1/2" (12.7 mm)	M12	100	220	20/120
YT-04355	1/2" (12.7 mm)	M14	100	370	20/120
YT-04356	1/2" (12.7 mm)	M16	100	590	20/120
YT-04357	1/2" (12.7 mm)	M17	100	590	20/120

EN Key wrench ratchet handle
PL Grzechołka Hex
DE Ratsche Hex
RU Трещотка Hex
CZ Ráčna Hex
HU Racsnis Hex
RO Antrenor cu dchet cu bit
FR Clé à cliquet Hex
IT Cricchetto Hex
ES Carraca Hex
CN 双向棘轮内六角扳手

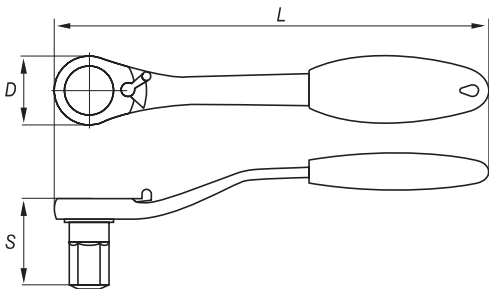

72T
HRC 42-48
CrV 50BV30

YATO	Ø [mm]	L [mm]	D [mm]	S [mm]	☐
YT-02390	4	135	18	29	8/160
YT-02391	5	135	18	29	8/160
YT-02392	6	145	23	32	6/120
YT-02393	8	145	23	32	6/120
YT-02394	10	190	31	35	6/60
YT-02395	12	190	31	35	6/60
YT-02396	14	225	36	36	5/40
YT-02397	17	225	36	36	5/40

EN Universal socket wrench
PL Klucz z uniwersalną nasadką
DE Universal-Steckschlüssel
RU Универсальная торцевая головка с трещоткой
CZ Univerzální klíč
HU Univerzális csavarkulcs
RO Antrenor cu dchet cu tubulara universala
FR Clé à douille universelle
IT Chiave con presa universale
ES Llave de tubo universal
CN 双向棘轮万能扳手

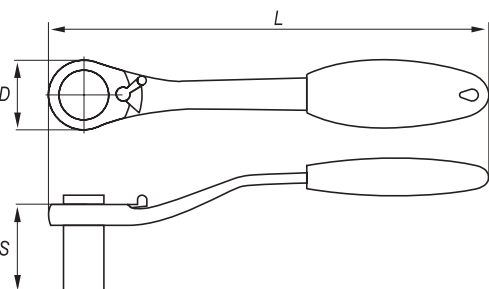

72T
HRC 40
CrV 50BV30



YATO	Ø [mm]	L [mm]	D [mm]	S [mm]	☐
YT-02400	8-19	225	36	54	5/40

EN Bit sockets
 PL Klucze trzpieniowe
 DE Bit-Stecknuss-Set
 RU Набор головок со вставкой
 CZ Sada nástrčných hlavíc s bitem
 HU Dugókulcs készlet
 RO Chei cu cozi
 FR Douille tournevis
 IT Serie di chiavi a bussola a giravite
 ES Juego de llaves de mandril
 CN 中孔星型旋具套筒组套

12 PCS		1/4" 6.3mm	3/8" 9.5mm	AISI S2
CrV 6150	HRC 58-62	DIN 3120		

EN Bit sockets
 PL Klucze trzpieniowe
 DE Bit-Stecknuss-Set
 RU Набор головок со вставкой
 CZ Sada nástrčných hlavíc s bitem
 HU Dugókulcs készlet
 RO Chei cu cozi
 FR Douille tournevis
 IT Serie di chiavi a bussola a giravite
 ES Juego de llaves de mandril
 CN 中孔星型旋具套筒组套

12 PCS		1/4" 6.3mm	3/8" 9.5mm	AISI S2
CrV 6150	HRC 58-62	DIN 3120		



1/4" (6.3 mm): T8, T10, T15, T20, T25, T27, T30 (L=37 mm);
 3/8" (9.5 mm): T40, T45, T47, T50, T55 (L=48 mm)

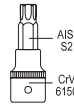

1/4" (6.3 mm): T8, T10, T15, T20, T25, T27, T30 (L=37 mm);
 3/8" (9.5 mm): T40, T45, T47, T50, T55 (L=48 mm)

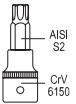

YATO	
YT-04331	10/40

YATO	
YT-04332	10/40

EN Bit sockets
 PL Klucze trzpieniowe
 DE Bit-Stecknuss-Set
 RU Набор головок со вставкой
 CZ Sada nástrčných hlavíc s bitem
 HU Dugókulcs készlet
 RO Chei cu cozi
 FR Douille tournevis
 IT Serie di chiavi a bussola a giravite
 ES Juego de llaves de mandril
 CN 中孔星型旋具套筒组套

9 PCS		1/4" 6.3mm	3/8" 9.5mm	AISI S2
CrV 6150	HRC 58-62	DIN 3120		

EN Bit sockets
 PL Klucze trzpieniowe
 DE Bit-Stecknuss-Set
 RU Набор головок со вставкой
 CZ Sada nástrčných hlavíc s bitem
 HU Dugókulcs készlet
 RO Chei cu cozi
 FR Douille tournevis
 IT Serie di chiavi a bussola a giravite
 ES Juego de llaves de mandril
 CN 中孔星型旋具套筒组套

5 PCS		1/4" 6.3mm	3/8" 9.5mm	AISI S2
CrV 6150	HRC 58-62	DIN 3120		



1/4" (6.3 mm): 2, 3, 4, 5, 6 mm (L=37 mm);
 3/8" (9.5 mm): 7, 8, 10, 12 mm (L=48 mm)

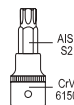

1/4" (6.3 mm): M5, M6 (L=37 mm);
 3/8" (9.5 mm): M8, M10, M12 (L=48 mm)

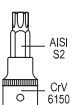

YATO	
YT-04401	6/36

YATO	
YT-04360	12/48

EN Bit sockets
 PL Klucze trzpieniowe
 DE Bit-Stecknuss-Set
 RU Набор головок со вставкой
 CZ Sada nástrčných hlavíc s bitem
 HU Dugókulcs készlet
 RO Chei cu cozi
 FR Douille tournevis
 IT Serie di chiavi a bussola a giravite
 ES Juego de llaves de mandril
 CN 中孔星型旋具套筒组套

7 PCS		1/4" 6.3mm	AISI S2	CrV 6150	DIN 3120	HRC 58-62	
----------	--	---------------	------------	-------------	-------------	--------------	--



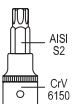

1/4" (6.3 mm): T10, T15, T20, T25, T27, T30, T40 (L=35 mm)



YATO	
YT-0461	12/48



- EN Bit socket set
- PL Zestaw kluczy trzpieniowych
- DE Aufsteckschlüssel-Satz
- RU Набор ронорок-эстабок
- CZ Čepové klíče
- HU Csapkulcs
- RO Chei cu cozi
- FR Set de douilles tournevis
- IT Chiavi a bussola a vite
- ES Juego de llaves de mandril
- CN 星型套筒批头组套



18 PCS		1/2" 12.7mm
1/4" 6.3mm	AISI S2	CrV 6150
DIN 3120	HRC 58-62	

2

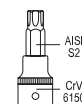

 1/2" (12.7 mm): T30, T40, T45, T50, T55, T60 (L=50 mm); T30, T40, T45, T50, T55, T60 (L=100 mm);
1/4" (6.3 mm): T10, T15, T20, T25, T30, T40 (L=37 mm); AISI S2 / CrV 6150

YATO 		
YT-7751	1/4" (6.3 mm), 1/2" (12.7 mm)	10





- EN Bit socket set
- PL Zestaw kluczy trzpieniowych
- DE Aufsteckschlüssel-Satz
- RU Набор ронорок-эстабок
- CZ Čepové klíče
- HU Csapkulcs
- RO Chei cu cozi
- FR Set de douilles tournevis
- IT Chiavi a bussola a vite
- ES Juego de llaves de mandril
- CN 批头组套





32 PCS		1/2" 12.7mm
S2	CrV	

 1/2" (12.7 mm): T20, T25, T27, T30, T40, T45, T50, T55, T60, T70 (L=55 mm);
1/2" (12.7 mm): T20, T25, T27, T30, T40, T45, T50, T55, T60, T70 (L=100 mm);
1/2" (12.7 mm): T40, T45, T50, T55, T60, T70 (L=140 mm);
1/2" (12.7 mm): T40, T45, T50, T55, T60, T70 (L=200 mm); S2 / CrV



YATO 		
YT-77541	1/2" (12.7 mm)	3

- EN Bit socket set
- PL Zestaw kluczy trzpieniowych
- DE Aufsteckschlüssel-Satz
- RU Набор ронорок-эстабок
- CZ Čepové klíče
- HU Csapkulcs
- RO Chei cu cozi
- FR Set de douilles tournevis
- IT Chiavi a bussola a vite
- ES Juego de llaves de mandril
- CN 六角套筒批头组套



18 PCS		1/2" 12.7mm
1/4" 6.3mm	AISI S2	CrV 6150
DIN 3120	HRC 58-62	

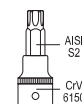

 1/2" (12.7 mm): 5, 6, 7, 8, 10, 12 mm (L=50 mm); 5, 6, 7, 8, 10, 12 mm (L=100 mm);
1/4" (6.3 mm): 3, 4, 5, 6, 7, 8 mm (L=37 mm); AISI S2 / CrV 6150

YATO 		
YT-7752	1/4" (6.3 mm), 1/2" (12.7 mm)	10





- EN Bit socket set
- PL Zestaw kluczy trzpieniowych
- DE Aufsteckschlüssel-Satz
- RU Набор роноров-вставок
- CZ Čepové klíče
- HU Csapkulcs
- RO Chei cu cozi
- FR Set de douilles tournevis
- IT Chiavi a bussola a vite
- ES Juego de llaves de mandril
- CN 批头组套





30 PCS		1/2" 12.7mm
S2	CrV	

-  1/2" (12.7 mm): 5, 6, 7, 8, 10, 12, 14, 17, 19 mm (L=55 mm);
- 1/2" (12.7 mm): 5, 6, 7, 8, 10, 11, 12, 13 mm (L=100 mm);
- 1/2" (12.7 mm): 5, 6, 7, 8, 10, 12, 14 mm (L=140 mm);
- 1/2" (12.7 mm): 5, 6, 7, 8, 10, 12 mm (L=200 mm); S2 / CrV



YATO 		
YT-77540	1/2" (12.7 mm)	3

- EN Bit socket set
- PL Zestaw kluczy trzpieniowych
- DE Aufsteckschlüssel-Satz
- RU Набор роноров-вставок
- CZ Čepové klíče
- HU Csapkulcs
- RO Chei cu cozi
- FR Set de douilles tournevis
- IT Chiavi a bussola a vite
- ES Juego de llaves de mandril
- CN 花型套筒批头组套



12 PCS		1/2" 12.7mm
AISI S2	CrV 6150	DIN 3120
HRC 58-62		

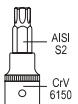

-  1/2" (12.7 mm): M12, M17 (L=50 mm); M6 (L=70 mm); M7, M8 (L=100 mm); M8, M10 (L=120 mm); M6, M10, M12 (L=140 mm); M5 (L=180 mm); M6 (L=250 mm); AISI S2 / CrV 6150

YATO 		
YT-7753	1/2" (12.7 mm)	10



- EN Bit socket set
- PL Zestaw kluczy trzpieniowych
- DE Aufsteckschlüssel-Satz
- RU Набор роноров-вставок
- CZ Čepové klíče
- HU Csapkulcs
- RO Chei cu cozi
- FR Set de douilles tournevis
- IT Chiavi a bussola a vite
- ES Juego de llaves de mandril
- CN 批头组套



26 PCS		1/2" 12.7mm
S2	CrV	

-  1/2" (12.7 mm): M5, M6, M8, M9, M10, M12, M14, M16 (L=55 mm);
- 1/2" (12.7 mm): M5, M6, M8, M9, M10, M12, M14 (L=100 mm);
- 1/2" (12.7 mm): M5, M6, M8, M9, M10, M12, M14 (L=140 mm);
- 1/2" (12.7 mm): M8, M10, M12, M14 (L=200 mm); S2 / CrV

YATO 		
YT-77542	1/2" (12.7 mm)	3