

<b>Floor laminate cutters</b> Gilotyny do cięcia paneli podłogowych	
.....	146

<b>Tile cutters &amp; accessories</b> Przyrządy do cięcia glazury i akcesoria	
.....	146-155

<b>Tile cutters</b> Przyrządy do glazury.....	146
--	-----

<b>Tile cutting pliers</b> Szcypce do glazury.....	147
---	-----

<b>Grout removers &amp; finishers</b> Skrobaki i szpachelki do fug.....	147
--	-----

<b>Accessories for tiles</b> Akcesoria do glazury.....	148
---	-----

<b>Burners &amp; soldering tools</b> Palniki i lutownice	
.....	155-156

<b>Gas burners &amp; accessories</b> Palniki gazowe i akcesoria	
.....	156-158

<b>Ladders &amp; supports</b> Drabiny i podpory	
.....	158-160

<b>Masonry tools</b> Narzędzia budowlane	
.....	160-185

<b>Floats</b> Pace.....	160
----------------------------	-----

<b>Trowels</b> Kielnie.....	163
--------------------------------	-----

<b>Plaster &amp; stucco spray guns</b> Tynkownice pneumatyczne.....	163
--	-----

<b>Tools for areated blocks</b> Narzędzia do betonu komórkowego.....	164
---	-----

<b>Tools for drywalls</b> Narzędzia do płyt gipsowo-kartonowych.....	165
---	-----

<b>Putty knives</b> Szpachelki.....	165
--	-----

<b>Scrapers</b> Skrobaki.....	169
----------------------------------	-----

<b>Mason's pans</b> Czerpaki murarskie.....	170
--	-----

<b>Building strainers</b> Sita budowlane.....	170
--	-----

<b>Paint mixers &amp; grout mixers</b> Mieszadła do farb i do zaprawy.....	170
---	-----

<b>Wallpapering tools</b> Narzędzia do tapetowania.....	172
--	-----

<b>Paint rollers &amp; accessories</b> Wałki do malowania i akcesoria.....	172
---	-----

<b>Paint brushes &amp; accessories</b> Pędzle malarskie i akcesoria.....	175
---	-----

<b>Painting sheets</b> Folie malarskie.....	177
--	-----

<b>Tapes</b> Taśmy.....	178
----------------------------	-----

<b>Plastic buckets &amp; tubs</b> Wiadra i kasty budowlane.....	179
--	-----

<b>Suction lifters</b> Uchwyty do szyb.....	180
--	-----

<b>Hooks „Juco”</b> Haki budowlane „Juco”.....	181
---	-----

<b>Pencils &amp; accessories</b> Ołówki i akcesoria.....	181
---	-----

<b>Benders</b> Giętarki.....	181
---------------------------------	-----

<b>Paving tools</b> Narzędzia brukarskie.....	182
--	-----

EN Floor laminate cutter  
 PL Gilotyna do cięcia paneli podłogowych  
 DE Laminat-Schneider  
 RU Гильотина для ламината  
 CZ Nůžky na laminátové plovoucí podlahy  
 RO Aparat de tăiat parchet laminat  
 HU Laminát padló vágógép  
 ES Guillotina cortapaneles

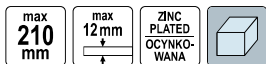

No.	Quantity
28880	2

EN Tile cutter  
 PL Przyrząd do cięcia glazury  
 DE Fliesenschneider  
 RU Плиткорез  
 CZ Příklad na řezání glazury  
 RO Mașină pt. tăiat faianța  
 HU Csempevágó  
 ES Cortadora de cerámica



No.	Cutting length / Długość cięcia [mm]	Guide bar diameter / Średnica prowadnicy [mm]	Quantity
00320	450	19	1

EN Tile cutter  
 PL Przyrząd do cięcia glazury  
 DE Fliesenschneider  
 RU Плиткорез  
 CZ Příklad na řezání glazury  
 RO Mașină pt. tăiat faianța  
 HU Csempevágó  
 ES Cortadora de cerámica



No.	Cutting length / Długość cięcia [mm]	Guide bar diameter / Średnica prowadnicy [mm]	Quantity
02300	280	16	6

EN Tile cutter  
 PL Przyrząd do cięcia glazury  
 DE Fliesenschneider  
 RU Плиткорез  
 CZ Příklad na řezání glazury  
 RO Mașină pt. tăiat faianța  
 HU Csempevágó  
 ES Cortadora de cerámica

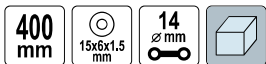

No.	Cutting length / Długość cięcia [mm]	Guide bar diameter / Średnica prowadnicy [mm]	Quantity
02400	400	14	6

EN Tile cutter  
 PL Przyrząd do cięcia glazury  
 DE Fliesenschneider  
 RU Плиткорез  
 CZ Příklad na řezání glazury  
 RO Mașină pt. tăiat faianța  
 HU Csempevágó  
 ES Cortadora de cerámica



No.	Cutting length / Długość cięcia [mm]	Guide bar diameter / Średnica prowadnicy [mm]	Quantity
00300	600	19	1

EN Tile cutter  
 PL Przyrząd do cięcia glazury  
 DE Fliesenschneider  
 RU Плиткорез  
 CZ Příklad na řezání glazury  
 RO Mașină pt. tăiat faianța  
 HU Csempevágó  
 ES Cortadora de cerámica



No.	Cutting length / Długość cięcia [mm]	Guide bar diameter / Średnica prowadnicy [mm]	Quantity
00510	500	16	1
00610	590	16	1

EN Tile cutter  
 PL Przyrząd do cięcia glazury  
 DE Fliesenschneider  
 RU Плиткорез  
 CZ Příklad na řezání glazury  
 RO Mașină pt. tăiat faianța  
 HU Csempevágó  
 ES Cortadora de cerámica

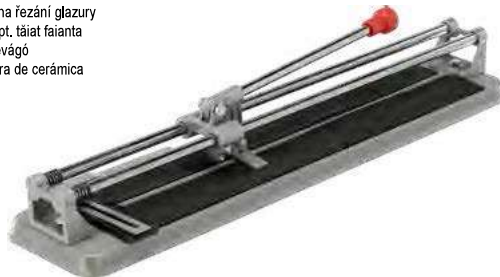

No.	Cutting length / Długość cięcia [mm]	Guide bar diameter / Średnica prowadnicy [mm]	Quantity
01060	600	15	1

EN Tile cutting wheel  
 PL Kółko wymienne ze śrubą  
 DE Schneidrad mit Schraube  
 RU Запасной ролик для плиткореза

CZ Výměnné kolečko se šroubem  
 RO Cutit rola  
 HU Cseregörgő csavarral  
 ES Recambio de cuchillo redondo



No.	Dimensions / Wymiary [mm]	For / Dla	Quantity
03150	15x6x1.5	02300, 02400	50/200
03160	16x6x3	00300, 00320	50/200
03220	22x6x2	00510, 00600, 00610, 01060	50/200

EN Tile cutting wheel  
 PL Kółko tnące wymienne  
 DE Schneiderrad  
 RU Запасной ролик для плиткореза  
 CZ Výměnné kolečko  
 RO Cuțit rolă  
 HU Cseregörgő csavarral  
 ES Recambio de cuchillo redondo



No.	Dimensions / Wymiary [mm]	For / Dla	
03221	22x10,5x2	00703	50/200

EN Tile cutting pliers  
 PL Szczypce do glazury  
 DE Glasurzange  
 RU Кусачки для плитки

CZ Kleště do glazury  
 RO Clește rupt faianța  
 HU Csempefogó  
 ES Tenazas para azulejos



No.	L [mm]	
04000	200	10/60

EN Tile cutting pliers  
 PL Szczypce do łamania glazury  
 DE Glasurzange  
 RU Кусачки для плитки  
 CZ Kleště do glazury  
 RO Clește rupt faianța  
 HU Csempefogó  
 ES Tenazas para azulejos

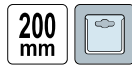

No.	L [mm]	
04022	200	6/60

EN Tile cutting nipper  
 PL Obcegi do glazury wygięte  
 DE Glasurzange  
 RU Клещи для плитки твердосплавные  
 CZ Kleště do glazury ohnuté  
 RO Clește curbate pt. glazură  
 HU Hajlított csempedarabfogó  
 ES Tenazas para azulejos curvo



No.	L [mm]	
04210	200	12/60

EN Tile cutting wheel  
 PL Kółko tnące wymienne  
 DE Schneiderrad  
 RU Ролик для плиткореза  
 CZ Výměnné kolečko  
 RO Cuțit rolă  
 HU Cseregörgő csavarral  
 ES Recambio de cuchillo redondo



No.	Dimensions / Wymiary [mm]	
03225	22x6x6	500

EN Tile cutting pliers  
 PL Szczypce do cięcia glazury  
 DE Glasurzange  
 RU Кусачки для плитки  
 CZ Kleště do glazury  
 RO Clește rupt faianța  
 HU Csempefogó  
 ES Tenazas para azulejos



No.	L [mm]	
04020	200	6/36

EN Tile cutting nipper  
 PL Szczypce do glazury  
 DE Glasurzange  
 RU Кусачки для плитки  
 CZ Kleště do glazury  
 RO Clește rupt faianța  
 HU Csempefogó  
 ES Tenazas para azulejos



No.	L [mm]	
04200	200	12/60

EN Grout finisher  
 PL Szpachelka do fugi  
 DE Fugenreiniger  
 RU Шпатель для затирки межплиточных швов  
 CZ Šúves skrôpers  
 RO Răzuitoare pt. rosturi  
 HU Fugakihúzó  
 ES Rascador para juntas



No.	
04410	450

EN Grout bag  
 PL Worek do aplikacji fugi  
 DE Fugenfüller-beutel  
 RU Мешок для нанесения расшивки

CZ Rukáv do spárování  
 RO Punga umplere rosturi  
 HU Fugázó zsák  
 ES Saco para la aplicación de juntas



No.		
04440		36/108

EN Tile laser  
 PL Laser glazurniczy  
 DE Fliesenlaser  
 RU Лазерный уровень для плитин  
 CZ Laserová vodováha  
 RO Nivel laser pt. plăci  
 HU Csempélézer  
 ES Láser de baldosas



No.	Vials / Libelle	
16030	2	20

EN Circular tile cutter  
 PL Wycinarka do otworów w glazurze  
 DE Fliesenlochbohrer mit Handschutz  
 RU Резак по плитке „Балеринка” с защитной решеткой  
 CZ Výseč otvorů v glazuře  
 RO Cuită rotativă tăiat faianță  
 HU Lyukkivágó csempéhez  
 ES Ruleta de corte para azulejos



No.	Cutting diameter / Średnica cięcia [mm]	
03940	20-94	24

EN Tile drilling guide  
 PL Prowadnica do wiercenia w płytkach  
 DE Führungsschiene zum Bohren in Fliesen  
 RU Направляющая для сверления плитки  
 CZ Vodítko pro vrtání v dlaždicích  
 RO Ghidaj pt. gaurit gresie  
 HU Csempé fúró vezető  
 ES Guía de brocas para baldosas



No.	Cutting diameter / Średnica cięcia [mm]	
03963	4, 5, 6, 8, 10, 12	12/36

EN Grout remover  
 PL Skrobak do fugi  
 DE Fugenreiniger  
 RU Скребок для швов плитки  
 CZ Škrábák na spáry  
 RO Spaclu pt. rosturi  
 HU Fugakihúzó  
 ES Rascador para juntas



No.	Blade size / Rozmiar ostrza [mm]	
04405	50x2	12/60

EN Circular tile cutter  
 PL Wycinarka do otworów w glazurze  
 DE Fliesenbohrzeug  
 RU Резак по плитке  
 CZ Výseč otvorů v glazuře  
 RO Cuită rotativă tăiat faianță  
 HU Lyukkivágó csempéhez  
 ES Ruleta de corte para azulejos

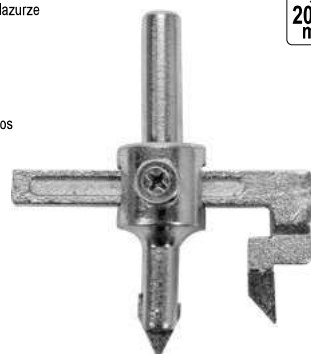

No.	Cutting diameter / Średnica cięcia [mm]	
03900	20-90	20/80

EN Adjustable plastic drill guide  
 PL Prowadnica do wiercenia w płytkach ceramicznych  
 DE Führungsschiene zum Bohren in Keramikfliesen  
 RU Направляющая для сверления керамической плитки  
 CZ Vodítko pro vrtání keramických obkládaček  
 RO Ghidaj gaurire ajustabil  
 HU Fúrószár vezető kerámia csempéhez  
 ES Guía para taladrar en azulejos cerámicos



No.	Cutting diameter / Średnica cięcia [mm]	
03960	4-24, 25-84	40

EN Hand tile cutter and breaker  
 PL Rysik do cięcia glazury  
 DE Fliesengriffel  
 RU Резак для плитки  
 CZ Rýsovací jehla na řezání glazury  
 RO Cuită tăiat / rupt faianță  
 HU Karctű csempévágáshoz  
 ES Cortador de azulejos



No.	L [mm]	
04050	130	50/400

EN TC tile cutter and breaker  
 PL Rysik do cięcia i lamania glazury  
 DE Fliesenriffel und Brecher  
 RU Плиткорез-карандаш с отплавивателем

CZ Rýsovací jehla na řezání a lámání glazury  
 RO Cutit taiat / rupt faianta  
 HU Karctű csempevágáshoz és töréshez  
 ES Cortador y rompedor de azulejos



No.	L [mm]	
04100	200	5/100

EN Tile leveling set  
 PL Przyrząd do poziomowania płytek  
 DE Schlagschnurgerät  
 RU Уровень для укладки кафеля  
 CZ Příklad pro regulaci úrovně dlaždiček  
 RO Fir pt. trasat  
 HU Padlóplanszintező eszköz  
 ES Nivelador de cuerda para azulejos

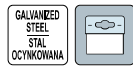

No.		
04500		60

EN Tile magnetic fittings  
 PL Uchwyty magnetyczne do płytek  
 DE Fliesen Magnete  
 RU Магнитные фитинги для плитки

CZ Magnety pod obklady  
 RO Balamale magnetice pt. imbinarea placilor  
 HU Csempevágnés  
 ES Trampilla magnética para la escotilla de inspección

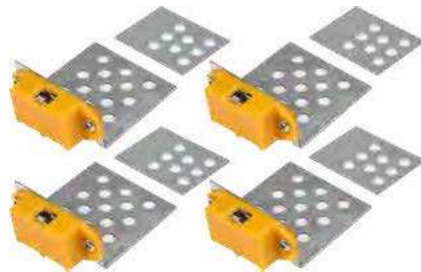

No.	pcs / szt.	
04490	4	50/100

EN Grouting sponge  
 PL Gąbka glazurnicza  
 DE Fliesenschwamm  
 RU Губка для затирки  
 CZ Houba na spárování obkladů  
 RO Burete pt. plăci ceramice  
 HU Csempézó szivacs  
 ES Esponja para azulejos

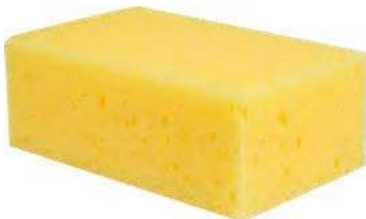

No.	Dimensions / Wymiary [mm]	
04540	165x100x60	74

EN Glass cutting tool  
 PL Nóż do płytek ceramicznych i szkła  
 DE Fliesen- und Glasschneider  
 RU Резак для керамической плитки и стекла  
 CZ Nůž na řezání keramických dlaždic a skla  
 RO Instrument de tăiat sticlă  
 HU Csempe- és üvegvágó kés  
 ES Cuchillo para cortar baldosas cerámicas y vidrio



No.	L [mm]	
04060	120	6/240

EN Magnetic lock  
 PL Maskownica uniwersalna  
 DE Universal verdeckung mit Magnet  
 RU Замок магнитный для кафеля  
 CZ Maskovací rám univerzální do glazury  
 RO Opritor magnetic  
 HU Univerzális maszkoló csempéhez  
 ES Cierre magnético universal



No.		
04510		40

EN Tile suction cup  
 PL Przyssawka do glazury  
 DE Saugnapf für Fliesen  
 RU Присоска для плитки  
 CZ Prísavka na obklady  
 RO Ventuze pt. plăci ceramice  
 HU Lapemelő tapadókorong  
 ES Ventosa para azulejos

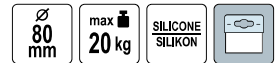

No.	Ø [mm]	Max. lifting capacity / Maks. udźwig [kg]	
05290	80	20	200

EN Grouting sponge  
 PL Gąbka glazurnicza  
 DE Fliesenschwamm  
 RU Губка для затирки  
 CZ Houba na spárování obkladů  
 RO Burete pt. plăci ceramice  
 HU Csempézó szivacs  
 ES Esponja para azulejos



No.	Dimensions / Wymiary [mm]	
04542	170x110x60	56

- EN Grouting sponge
- PL Gąbka glazuryczna
- DE Fliesenschwamm
- RU Губка для затирки
- CZ Houba na spráování obkladů
- RO Burete pt. plăci ceramice
- HU Csempézó szivacs
- ES Esponja para azulejos

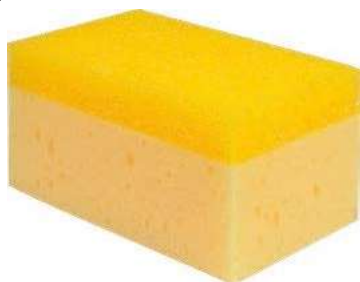

No.	Dimensions / Wymiary [mm]	
04544	165x100x80	18

- EN Glaze bucket
- PL Wiadro glazuryczna
- DE Fliesenwaschset Rolleneimer
- RU Ведро с роликом для затирки швов
- CZ Malířské vědro
- RO Galeata pt. zugravit
- HU Fugázó vödör
- ES Cubo de pintura



No.	Capacity / Pojemność [l]	
00250	10	2

- EN Tile leveling system (clips)
- PL System poziomowania płytek (klipsy)
- DE Fliesen Nivelliersystem (Clips)
- RU Система выравнивания плитки (зажимы)
- CZ Systém vyrovnání dlaždic (spony)
- RO Sistem nivelare plăci (deme)
- HU Csempeszintező rendszer (talpak)
- ES Sistema de nivelación de baldosas (clips)

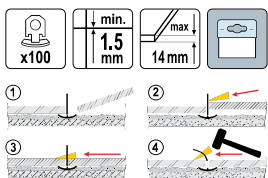

**FEATURES:**

- Useful when laying tiles on floors and walls
- Work great for large tiles
- Use with tiles of different thickness
- For use with 04718 wedges
- Save time and make work easy and efficient

**CECHY:**

- Ułatwia układanie płytek na ścianach i podłodze
- Szczególnie przydatny do płytek o większych rozmiarach
- Umożliwia poziomowanie płytek o różnych grubościach
- Do użytku z klinami 04718
- Ułatwia i przyspiesza prace



30x30	33x33	40x40	45x45	50x50	60x60	80x80	60x30	100x50	120x60
42	36	20	28	24	10	10	22	16	10

NUMBER OF CLIPS FOR VARIOUS DIMENSIONS TILES PER 1 M<sup>2</sup>  
LICZBA KLIPSÓW NA M<sup>2</sup> W ZALEŻNOŚCI OD ROZMIARU PŁYTKI



No.	pcs / szt.	
04690	100	15

- EN Grouting sponge
- PL Gąbka glazuryczna
- DE Fliesenschwamm
- RU Губка для затирки
- CZ Houba na spráování obkladů
- RO Burete pt. plăci ceramice
- HU Csempézó szivacs
- ES Esponja para azulejos



No.	Dimensions / Wymiary [mm]	
04546	150x100x50	10

- EN Tile leveling floor pliers
- PL Szczypce do poziomowania płytek
- DE Nivelliersystem Zange
- RU Щипцы до системы нивелировки
- CZ Kleště pro dlaždice vyrovnání
- RO Clește de nivelat gresie reglabil
- HU Lapszintező speciális fogó
- ES Tenaza para sistema de nivelación



No.		
04699		5/30

- EN Tile leveling system (clips and wedges)
- PL System poziomowania płytek (klipsy i kliny)
- DE Fliesen Nivelliersystem (Clips und Keile)
- RU Система выравнивания плитки (зажимы и клинья)
- CZ Systém vyrovnání dlaždic (spony a kliny)
- RO Sistem nivelare plăci (cleme si pene)
- HU Csempeszintező rendszer (talpak és ékek)
- ES Sistema de nivelación de baldosas (clips y cuñas)

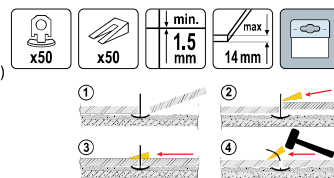

**FEATURES:**

- Useful when laying tiles on floors and walls
- Work great for large tiles
- Use with tiles of different thickness
- Wedges are reusable
- Save time and make work easy and efficient

**CECHY:**

- Ułatwia układanie płytek na ścianach i podłodze
- Szczególnie przydatny do płytek o większych rozmiarach
- Umożliwia poziomowanie płytek o różnych grubościach
- Kliny wielokrotnego użytku
- Ułatwia i przyspiesza prace



30x30	33x33	40x40	45x45	50x50	60x60	80x80	60x30	100x50	120x60
42	36	20	28	24	10	10	22	16	10

NUMBER OF CLIPS FOR VARIOUS DIMENSIONS TILES PER 1 M<sup>2</sup>  
LICZBA KLIPSÓW NA M<sup>2</sup> W ZALEŻNOŚCI OD ROZMIARU PŁYTKI



No.	pcs / szt.	
04691	50+50	15

EN Tile leveling system (clips and wedges)  
 PL System poziomowania płytek (klipsy i kliny)  
 DE Fliesen Nivelliersystem (Clips und Keile)  
 RU Система выравнивания плитки (зажимы и клинья)  
 CZ Systém vyrovnávání dlaždic (spony a kliny)  
 RO Sistem nivelare plăci (deme si pene)  
 HU Csempezintező rendszer (talpak és ékek)  
 ES Sistema de nivelación de baldosas (clips y cuñas)

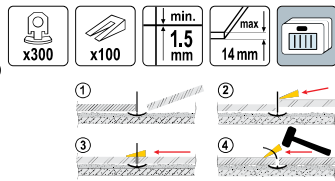

**FEATURES:**

- Useful when laying tiles on floors and walls
- Work great for large tiles
- Use with tiles of different thickness
- Wedges are reusable
- Save time and make work easy and efficient

**CECHY:**

- Ułatwia układanie płytek na ścianach i podłodze
- Szczególnie przydatny do płytek o większych rozmiarach
- Umożliwia poziomowanie płytek o różnych grubościach
- Kliny wielokrotnego użytku
- Ułatwia i przyspiesza prace

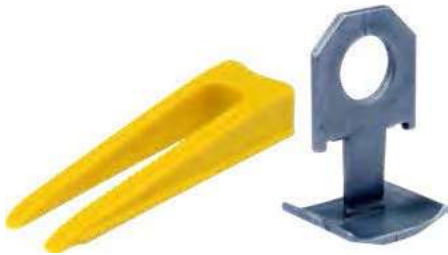

30x30	33x33	40x40	45x45	50x50	60x60	80x80	60x30	100x50	120x60
42	36	20	28	24	10	10	22	16	10

NUMBER OF CLIPS FOR VARIOUS DIMENSIONS TILES PER 1 M<sup>3</sup>  
 LICZBA KLIPSÓW NA M<sup>3</sup> W ZALEŻNOŚCI OD ROZMIARU PŁYTKI



No.	pcs / szt.	
04692	300+100	1

EN Tile leveling system (clips and wedges)  
 PL System poziomowania płytek (klipsy i kliny)  
 DE Fliesen Nivelliersystem (Clips und Keile)  
 RU Система выравнивания плитки (зажимы и клинья)  
 CZ Systém vyrovnávání dlaždic (spony a kliny)  
 RO Sistem nivelare plăci (deme si pene)  
 HU Csempezintező rendszer (talpak és ékek)  
 ES Sistema de nivelación de baldosas (clips y cuñas)

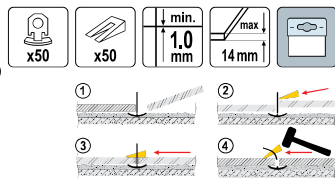

**FEATURES:**

- Useful when laying tiles on floors and walls
- Work great for large tiles
- Use with tiles of different thickness
- Wedges are reusable
- Save time and make work easy and efficient

**CECHY:**

- Ułatwia układanie płytek na ścianach i podłodze
- Szczególnie przydatny do płytek o większych rozmiarach
- Umożliwia poziomowanie płytek o różnych grubościach
- Kliny wielokrotnego użytku
- Ułatwia i przyspiesza prace



30x30	33x33	40x40	45x45	50x50	60x60	80x80	60x30	100x50	120x60
42	36	20	28	24	10	10	22	16	10

NUMBER OF CLIPS FOR VARIOUS DIMENSIONS TILES PER 1 M<sup>3</sup>  
 LICZBA KLIPSÓW NA M<sup>3</sup> W ZALEŻNOŚCI OD ROZMIARU PŁYTKI



No.	pcs / szt.	
04714	50+50	15

EN Tile leveling system (clips)  
 PL System poziomowania płytek (klipsy)  
 DE Fliesen Nivelliersystem (Clips)  
 RU Система выравнивания плитки (зажимы)  
 CZ Systém vyrovnávání dlaždic (spony)  
 RO Sistem nivelare plăci (deme)  
 HU Csempezintező rendszer (talpak)  
 ES Sistema de nivelación de baldosas (clips)

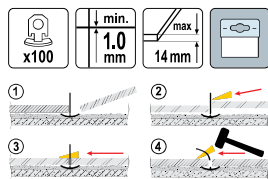

**FEATURES:**

- Useful when laying tiles on floors and walls
- Work great for large tiles
- Use with tiles of different thickness
- For use with 04718 wedges
- Save time and make work easy and efficient

**CECHY:**

- Ułatwia układanie płytek na ścianach i podłodze
- Szczególnie przydatny do płytek o większych rozmiarach
- Umożliwia poziomowanie płytek o różnych grubościach
- Do użytku z klinami 04718
- Ułatwia i przyspiesza prace



30x30	33x33	40x40	45x45	50x50	60x60	80x80	60x30	100x50	120x60
42	36	20	28	24	10	10	22	16	10

NUMBER OF CLIPS FOR VARIOUS DIMENSIONS TILES PER 1 M<sup>3</sup>  
 LICZBA KLIPSÓW NA M<sup>3</sup> W ZALEŻNOŚCI OD ROZMIARU PŁYTKI



No.	pcs / szt.	
04716	100	15

EN Tile leveling system (clips)  
 PL System poziomowania płytek (klipsy)  
 DE Fliesen Nivelliersystem (Clips)  
 RU Система выравнивания плитки (зажимы)  
 CZ Systém vyrovnávání dlaždic (spony)  
 RO Sistem nivelare plăci (deme)  
 HU Csempezintező rendszer (talpak)  
 ES Sistema de nivelación de baldosas (clips)

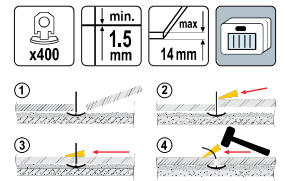

**FEATURES:**

- Useful when laying tiles on floors and walls
- Work great for large tiles
- Use with tiles of different thickness
- For use with 04718 wedges
- Save time and make work easy and efficient

**CECHY:**

- Ułatwia układanie płytek na ścianach i podłodze
- Szczególnie przydatny do płytek o większych rozmiarach
- Umożliwia poziomowanie płytek o różnych grubościach
- Do użytku z klinami 04718
- Ułatwia i przyspiesza prace



30x30	33x33	40x40	45x45	50x50	60x60	80x80	60x30	100x50	120x60
42	36	20	28	24	10	10	22	16	10

NUMBER OF CLIPS FOR VARIOUS DIMENSIONS TILES PER 1 M<sup>3</sup>  
 LICZBA KLIPSÓW NA M<sup>3</sup> W ZALEŻNOŚCI OD ROZMIARU PŁYTKI



No.	pcs / szt.	
04693	400	1

EN Tile leveling system (clips and wedges)  
 PL System poziomowania płytek (klipsy i kliny)  
 DE Fliesen Nivelliersystem (Clips und Keile)  
 RU Система выравнивания плитки (зажимы и клинья)  
 CZ Systém vyrovnávání dlaždic (spony a kliny)  
 RO Sistem nivelare plăci (deme si pene)  
 HU Csempezintező rendszer (talpak és ékek)  
 ES Sistema de nivelación de baldosas (clips y cuñas)

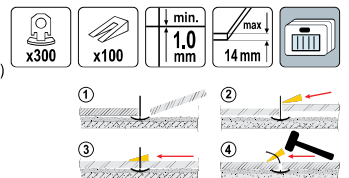

**FEATURES:**

- Useful when laying tiles on floors and walls
- Work great for large tiles
- Use with tiles of different thickness
- Wedges are reusable
- Save time and make work easy and efficient

**CECHY:**

- Ułatwia układanie płytek na ścianach i podłodze
- Szczególnie przydatny do płytek o większych rozmiarach
- Umożliwia poziomowanie płytek o różnych grubościach
- Kliny wielokrotnego użytku
- Ułatwia i przyspiesza prace



30x30	33x33	40x40	45x45	50x50	60x60	80x80	60x30	100x50	120x60
42	36	20	28	24	10	10	22	16	10

NUMBER OF CLIPS FOR VARIOUS DIMENSIONS TILES PER 1 M<sup>3</sup>  
 LICZBA KLIPSÓW NA M<sup>3</sup> W ZALEŻNOŚCI OD ROZMIARU PŁYTKI



No.	pcs / szt.	
04715	300+100	1

EN Tile leveling system (clips)  
 PL System poziomowania płytek (klipsy)  
 DE Fliesen Nivelliersystem (Clips)  
 RU Система выравнивания плитки (зажимы)  
 CZ Systém vyrovnávání dlaždic (spony)  
 RO Sistem nivelare plăci (deme)  
 HU Csempezintező rendszer (talpak)  
 ES Sistema de nivelación de baldosas (clips)

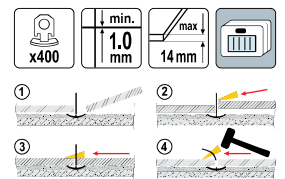

**FEATURES:**

- Useful when laying tiles on floors and walls
- Work great for large tiles
- Use with tiles of different thickness
- For use with 04718 wedges
- Save time and make work easy and efficient

**CECHY:**

- Ułatwia układanie płytek na ścianach i podłodze
- Szczególnie przydatny do płytek o większych rozmiarach
- Umożliwia poziomowanie płytek o różnych grubościach
- Do użytku z klinami 04718
- Ułatwia i przyspiesza prace



30x30	33x33	40x40	45x45	50x50	60x60	80x80	60x30	100x50	120x60
42	36	20	28	24	10	10	22	16	10

NUMBER OF CLIPS FOR VARIOUS DIMENSIONS TILES PER 1 M<sup>3</sup>  
 LICZBA KLIPSÓW NA M<sup>3</sup> W ZALEŻNOŚCI OD ROZMIARU PŁYTKI



No.	pcs / szt.	
04717	400	1

EN Tile leveling system (wedges)  
 PL System poziomowania płytek (kliny)  
 DE Fliesen Nivelliersystem (Keile)  
 RU Система выравнивания плитки (клинья)  
 CZ Systém vyrovnávání dlaždic (kliny)  
 RO Sistem nivelare plăci (pene)  
 HU Csempezintező rendszer (ékek)  
 ES Sistema de nivelación de baldosas (cuñas)

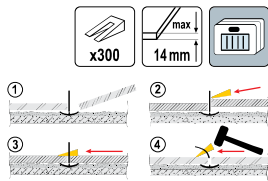

**FEATURES:**

- Useful when laying tiles on floors and walls
- Work great for large tiles
- Use with tiles of different thickness
- Wedges are reusable
- Save time and make work easy and efficient

**CECHY:**

- Ułatwia układanie płytek na ścianach i podłodze
- Szczególnie przydatny do płytek o większych rozmiarach
- Umożliwia poziomowanie płytek o różnych grubościach
- Kliny wielokrotnego użytku
- Ułatwia i przyspiesza prace



30x30	33x33	40x40	45x45	50x50	60x60	80x80	60x30	100x50	120x60
42	36	20	28	24	10	10	22	16	10

NUMBER OF CLIPS FOR VARIOUS DIMENSIONS TILES PER 1 M<sup>2</sup>  
 LICZBA KLIPSÓW NA M<sup>2</sup> W ZALEŻNOŚCI OD ROZMIARU PŁYTKI



No.	pcs / szt.	For / Dla	
04718	300	04690, 04693, 04716, 04717	1

11

EN Tile leveling system (clips and wedges)  
 PL System poziomowania płytek (klipsy i kliny)  
 DE Fliesen Nivelliersystem (Clips und Keile)  
 RU Система выравнивания плитки (зажимы и клинья)  
 CZ Systém vyrovnávání dlaždic (spony a kliny)  
 RO Sistem nivelare plăci (deme și pene)  
 HU Csempezintező rendszer (talpak és ékek)  
 ES Sistema de nivelación de baldosas (clips y cuñas)

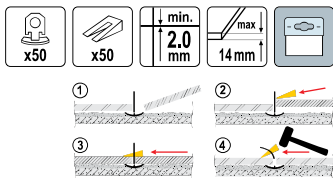

**FEATURES:**

- Useful when laying tiles on floors and walls
- Work great for large tiles
- Use with tiles of different thickness
- Wedges are reusable
- Save time and make work easy and efficient

**CECHY:**

- Ułatwia układanie płytek na ścianach i podłodze
- Szczególnie przydatny do płytek o większych rozmiarach
- Umożliwia poziomowanie płytek o różnych grubościach
- Kliny wielokrotnego użytku
- Ułatwia i przyspiesza prace



30x30	33x33	40x40	45x45	50x50	60x60	80x80	60x30	100x50	120x60
42	36	20	28	24	10	10	22	16	10

NUMBER OF CLIPS FOR VARIOUS DIMENSIONS TILES PER 1 M<sup>2</sup>  
 LICZBA KLIPSÓW NA M<sup>2</sup> W ZALEŻNOŚCI OD ROZMIARU PŁYTKI



No.	pcs / szt.	
04731	50+50	15

EN Tile leveling system (clips)  
 PL System poziomowania płytek (klipsy)  
 DE Fliesen Nivelliersystem (Clips)  
 RU Система выравнивания плитки (зажимы)  
 CZ Systém vyrovnávání dlaždic (spony)  
 RO Sistem nivelare plăci (deme)  
 HU Csempezintező rendszer (talpak)  
 ES Sistema de nivelación de baldosas (clips)

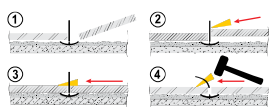

No.	pcs / szt.	
04734	400	1

EN Tile leveling system (clips)  
 PL System poziomowania płytek (klipsy)  
 DE Fliesen Nivelliersystem (Clips)  
 RU Система выравнивания плитки (зажимы)  
 CZ Systém vyrovnávání dlaždic (spony)  
 RO Sistem nivelare plăci (cleme)  
 HU Csempezintező rendszer (talpak)  
 ES Sistema de nivelación de baldosas (clips)

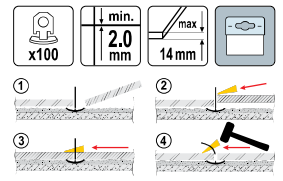

**FEATURES:**

- Useful when laying tiles on floors and walls
- Work great for large tiles
- Use with tiles of different thickness
- For use with 04718 wedges
- Save time and make work easy and efficient

**CECHY:**

- Ułatwia układanie płytek na ścianach i podłodze
- Szczególnie przydatny do płytek o większych rozmiarach
- Umożliwia poziomowanie płytek o różnych grubościach
- Do użytku z klinami 04718
- Ułatwia i przyspiesza prace



30x30	33x33	40x40	45x45	50x50	60x60	80x80	60x30	100x50	120x60
42	36	20	28	24	10	10	22	16	10

NUMBER OF CLIPS FOR VARIOUS DIMENSIONS TILES PER 1 M<sup>2</sup>  
 LICZBA KLIPSÓW NA M<sup>2</sup> W ZALEŻNOŚCI OD ROZMIARU PŁYTKI



No.	pcs / szt.	
04730	100	15

EN Tile leveling system (clips and wedges)  
 PL System poziomowania płytek (klipsy i kliny)  
 DE Fliesen Nivelliersystem (Clips und Keile)  
 RU Система выравнивания плитки (зажимы и клинья)  
 CZ Systém vyrovnávání dlaždic (spony a kliny)  
 RO Sistem nivelare plăci (deme și pene)  
 HU Csempezintező rendszer (talpak és ékek)  
 ES Sistema de nivelación de baldosas (clips y cuñas)

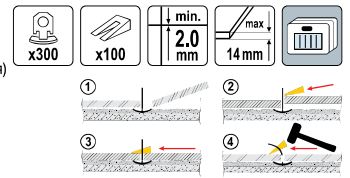

**FEATURES:**

- Useful when laying tiles on floors and walls
- Work great for large tiles
- Use with tiles of different thickness
- Wedges are reusable
- Save time and make work easy and efficient

**CECHY:**

- Ułatwia układanie płytek na ścianach i podłodze
- Szczególnie przydatny do płytek o większych rozmiarach
- Umożliwia poziomowanie płytek o różnych grubościach
- Kliny wielokrotnego użytku
- Ułatwia i przyspiesza prace



30x30	33x33	40x40	45x45	50x50	60x60	80x80	60x30	100x50	120x60
42	36	20	28	24	10	10	22	16	10

NUMBER OF CLIPS FOR VARIOUS DIMENSIONS TILES PER 1 M<sup>2</sup>  
 LICZBA KLIPSÓW NA M<sup>2</sup> W ZALEŻNOŚCI OD ROZMIARU PŁYTKI



No.	pcs / szt.	
04732	300+100	1



**FEATURES:**

- Useful when laying tiles on floors and walls
- Work great for large tiles
- Use with tiles of different thickness
- For use with 04718 wedges
- Save time and make work easy and efficient

**CECHY:**

- Ułatwia układanie płytek na ścianach i podłodze
- Szczególnie przydatny do płytek o większych rozmiarach
- Umożliwia poziomowanie płytek o różnych grubościach
- Do użytku z klinami 04718
- Ułatwia i przyspiesza prace

30x30	33x33	40x40	45x45	50x50	60x60	80x80	60x30	100x50	120x60
42	36	20	28	24	10	10	22	16	10

NUMBER OF CLIPS FOR VARIOUS DIMENSIONS TILES PER 1 M<sup>2</sup>  
 LICZBA KLIPSÓW NA M<sup>2</sup> W ZALEŻNOŚCI OD ROZMIARU PŁYTKI

EN Tile leveling system (clips)  
 PL System poziomowania płytek (klipsy)  
 DE Fliesen Nivelliersystem (Clips)  
 RU Система выравнивания плитки (зажимы)  
 CZ Systém vyrovnávání dlaždic (spony)  
 RO Sistem nivelare plăci (deme)  
 HU Csempeszintező rendszer (talpak)  
 ES Sistema de nivelación de baldosas (clips)

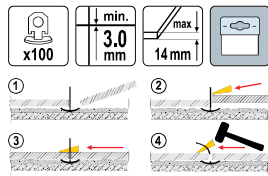

- FEATURES:**
- Useful when laying tiles on floors and walls
  - Work great for large tiles
  - Use with tiles of different thickness
  - For use with 04718 wedges
  - Save time and make work easy and efficient

- CECHY:**
- Ułatwia układanie płytek na ścianach i podłodze
  - Szczególnie przydatny do płytek o większych rozmiarach
  - Umożliwia poziomowanie płytek o różnych grubościach
  - Do użytku z klinami 04718
  - Ułatwia i przyspiesza pracę

30x30	33x33	40x40	45x45	50x50	60x60	80x80	60x30	100x50	120x60
42	36	20	28	24	10	22	16	10	10

NUMBER OF CLIPS FOR VARIOUS DIMENSIONS TILES PER 1 M<sup>3</sup>  
 LICZBA KLIPSÓW NA M<sup>3</sup> W ZALEŻNOŚCI OD ROZMIARU PŁYTKI

<b>No.</b>	pcs / szt.	
04735	100	15

EN Tile leveling system (clips and wedges)  
 PL System poziomowania płytek (klipsy i kliny)  
 DE Fliesen Nivelliersystem (Clips und Keile)  
 RU Система выравнивания плитки (зажимы и клинья)  
 CZ Systém vyrovnávání dlaždic (spony a kliny)  
 RO Sistem nivelare plăci (deme si pene)  
 HU Csempeszintező rendszer (talpak és ékek)  
 ES Sistema de nivelación de baldosas (clips y cuñas)

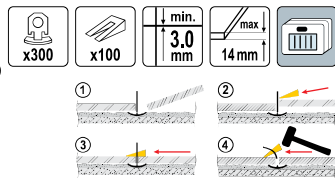

- FEATURES:**
- Useful when laying tiles on floors and walls
  - Work great for large tiles
  - Use with tiles of different thickness
  - Wedges are reusable
  - Save time and make work easy and efficient

- CECHY:**
- Ułatwia układanie płytek na ścianach i podłodze
  - Szczególnie przydatny do płytek o większych rozmiarach
  - Umożliwia poziomowanie płytek o różnych grubościach
  - Kliny wielokrotnego użytku
  - Ułatwia i przyspiesza pracę

30x30	33x33	40x40	45x45	50x50	60x60	80x80	60x30	100x50	120x60
42	36	20	28	24	10	22	16	10	10

NUMBER OF CLIPS FOR VARIOUS DIMENSIONS TILES PER 1 M<sup>3</sup>  
 LICZBA KLIPSÓW NA M<sup>3</sup> W ZALEŻNOŚCI OD ROZMIARU PŁYTKI

<b>No.</b>	pcs / szt.	
04737	300+100	1

EN Tile leveling system  
 PL Klipsy poziomujące płytki  
 DE Fliesen-Ausgleichssystem  
 RU Система выравнивания плитки-зажим СВПТ  
 CZ Dlaždice nivelační systém  
 RO Sistemul de nivelare plăci  
 HU Csempeszintező rendszer  
 ES Sistema de nivelación del azulejo



- FEATURES:**
- Useful when laying tiles on floors and walls
  - Work great for large tiles
  - Use with tiles of different thickness
  - Save time and make work easy and efficient

- CECHY:**
- Ułatwiają układanie płytek na ścianach i podłodze
  - Szczególnie przydatne do płytek o większych rozmiarach
  - Umożliwiają poziomowanie płytek o różnych grubościach
  - Ułatwiają i przyspieszają pracę

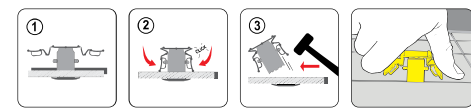

30x30	33x33	40x40	45x45	50x50	60x60	80x80	60x30	100x50	120x60
42	36	20	28	24	10	22	16	10	10

NUMBER OF CLIPS FOR VARIOUS DIMENSIONS TILES PER 1 M<sup>3</sup>  
 LICZBA KLIPSÓW NA M<sup>3</sup> W ZALEŻNOŚCI OD ROZMIARU PŁYTKI

<b>No.</b>	pcs / szt.	
04677	100	1

EN Tile leveling system (clips and wedges)  
 PL System poziomowania płytek (klipsy i kliny)  
 DE Fliesen Nivelliersystem (Clips und Keile)  
 RU Система выравнивания плитки (зажимы и клинья)  
 CZ Systém vyrovnávání dlaždic (spony a kliny)  
 RO Sistem nivelare plăci (deme si pene)  
 HU Csempeszintező rendszer (talpak és ékek)  
 ES Sistema de nivelación de baldosas (clips y cuñas)

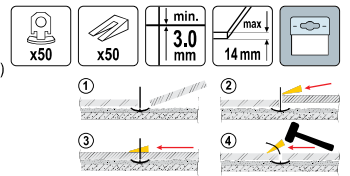

- FEATURES:**
- Useful when laying tiles on floors and walls
  - Work great for large tiles
  - Use with tiles of different thickness
  - Wedges are reusable
  - Save time and make work easy and efficient

- CECHY:**
- Ułatwia układanie płytek na ścianach i podłodze
  - Szczególnie przydatny do płytek o większych rozmiarach
  - Umożliwia poziomowanie płytek o różnych grubościach
  - Kliny wielokrotnego użytku
  - Ułatwia i przyspiesza pracę

30x30	33x33	40x40	45x45	50x50	60x60	80x80	60x30	100x50	120x60
42	36	20	28	24	10	22	16	10	10

NUMBER OF CLIPS FOR VARIOUS DIMENSIONS TILES PER 1 M<sup>3</sup>  
 LICZBA KLIPSÓW NA M<sup>3</sup> W ZALEŻNOŚCI OD ROZMIARU PŁYTKI

<b>No.</b>	pcs / szt.	
04736	50+50	15

EN Tile leveling system (clips)  
 PL System poziomowania płytek (klipsy)  
 DE Fliesen Nivelliersystem (Clips)  
 RU Система выравнивания плитки (зажимы)  
 CZ Systém vyrovnávání dlaždic (spony)  
 RO Sistem nivelare plăci (deme)  
 HU Csempeszintező rendszer (talpak)  
 ES Sistema de nivelación de baldosas (clips)

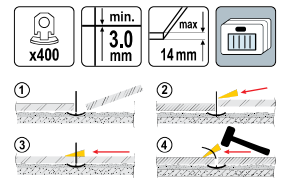

- FEATURES:**
- Useful when laying tiles on floors and walls
  - Work great for large tiles
  - Use with tiles of different thickness
  - For use with 04718 wedges
  - Save time and make work easy and efficient

- CECHY:**
- Ułatwia układanie płytek na ścianach i podłodze
  - Szczególnie przydatny do płytek o większych rozmiarach
  - Umożliwia poziomowanie płytek o różnych grubościach
  - Do użytku z klinami 04718
  - Ułatwia i przyspiesza pracę

30x30	33x33	40x40	45x45	50x50	60x60	80x80	60x30	100x50	120x60
42	36	20	28	24	10	22	16	10	10

NUMBER OF CLIPS FOR VARIOUS DIMENSIONS TILES PER 1 M<sup>3</sup>  
 LICZBA KLIPSÓW NA M<sup>3</sup> W ZALEŻNOŚCI OD ROZMIARU PŁYTKI

<b>No.</b>	pcs / szt.	
04739	400	1

EN Starter kit for levelling ceramic tiles  
 PL Zestaw startowy do poziomowania płytek  
 DE Startset für Nivellierung der Fliesen  
 RU Базовый комплект для выравнивания плитки  
 CZ Startovací sada pro vyrovnávání dlaždic  
 RO Kit pt. nivelat plăci ceramice  
 HU Csempeszintező kezdőkészlet  
 ES Kit inicial de nivelación de azulejos



- FEATURES:**
- Useful when laying tiles on floors and walls
  - Work great for large tiles
  - Use with tiles of different thickness
  - Save time and make work easy and efficient

- CECHY:**
- Ułatwia układanie płytek na ścianach i podłodze
  - Szczególnie przydatny do płytek o większych rozmiarach
  - Umożliwiają poziomowanie płytek o różnych grubościach
  - Ułatwia i przyspiesza pracę



<b>No.</b>	pcs / szt.	
04680	201	6/12

EN Additional tile levelling straps  
 PL Paski dodatkowe do zestawu do poziomowania płytek  
 DE Zusätzliche Stifte zum Set für Nivellierung der Fliesen  
 RU Дополнительные полоски для комплекта для выравнивания плитки  
 CZ Dodatkové pásky k sadě pro vyrovnání dlaždic  
 RO Benzii pt. nivelat placii  
 HU Plusz szjzak csempeszintező készlethez  
 ES Tiras auxiliares para el kit de nivelación de azulejos



No.	pcs / szt.	
04681	100	18

EN Additional tile levelling cups and straps  
 PL Paski i kubki dodatkowe do zestawu do poziomowania płytek  
 DE Zusätzliche Stifte und Kappen zum Set für Nivellierung der Fliesen  
 RU Дополнительные полоски и колпачки для комплекта для выравнивания плитки  
 CZ Dodatkové pásky a pohárky k sadě pro vyrovnání dlaždic  
 RO Benzii si cupe pt. nivelat placii ceramice  
 HU Plusz szjzak és feltétek csempeszintező készlethez  
 ES Tiras y cuñas auxiliares para el kit de nivelación de azulejos



No.	pcs / szt.	
04683	100	24

EN Cross shape tile spacers  
 PL Krzyżki dystansowe  
 DE Fliesenkreuze  
 RU Крестики для плитки

CZ Distanční křížky  
 RO Distanțiere în cruce  
 HU Hézagoló kereszt  
 ES Crucetas para juntas



No.	Thickness / Grubość [mm]	pcs / szt.	
04600	1.5	200	100
04610	2.0	200	100
04620	2.5	200	100
04630	3.0	150	100
04640	4.0	100	100
04650	5.0	100	100
04660	6.0	75	12/100
04668	8.0	30	100
04670	10.0	30	100

EN Additional tile levelling cups  
 PL Kubki dodatkowe do zestawu do poziomowania płytek  
 DE Zusätzliche Kappen zum Set für Nivellierung der Fliesen  
 RU Дополнительные колпачки для комплекта для выравнивания плитки  
 CZ Dodatkové pohárky k sadě pro vyrovnání dlaždic  
 RO Cupe pt. nivelat placii ceramice  
 HU Plusz feltétek csempeszintező készlethez  
 ES Cuñas auxiliares para el kit de nivelación de azulejos



No.	pcs / szt.	
04682	100	30

EN Levelling tongs for precision levelling straps  
 PL Szczypce do zaciągania pasków poziomujących  
 DE Spannzange für Nivellierstifte  
 RU Щипцы для затягивания выравнивающих полосок  
 CZ Kleště do utahování vyrovnávacích pásků  
 RO Dispozitiv pt. nivelare  
 HU Szintezőszij húzó fogó  
 ES Pinzas para tensar tiras de nivelación

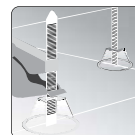

No.		
04684		12/48

EN Wedges for wall and floor tiles  
 PL Kliny do glazury  
 DE Keile für Wand und Bodenfliesen  
 RU Клинья для плитки  
 CZ Kliny do glazury  
 RO Distanțiere faianță  
 HU Ék csempéhez  
 ES Cuñas para juntas de azulejos



No.	Thickness / Grubość [mm]	pcs / szt.	
04700	4	100	100
04710	7	50	100

EN Cross shape tile spacers  
 PL Krzyżyki dystansowe  
 DE Fliesenkreuze  
 RU Крестики для плитки  
 CZ Distanční křížky  
 RO Distanțiere in cruce  
 HU Hézagoló kereszt  
 ES Crucetas para juntas



No.	Thickness / Grubość [mm]	pcs / szt.	
04591	5	50	100
04592	6	50	100
04593	8	30	100
04594	10	30	100

EN Gas soldering lamp  
 PL Gazowa lampa lutownicza  
 DE Gaslötlampe  
 RU Газовая паяльная лампа  
 CZ Plynová pájecí lampka  
 RO Lampă de lipit pe gaz  
 HU Gázos forrasztólámpa  
 ES Lampa de gas para soldar

1.7 kW max °C 1200 123 g/h BUTANE BUTAN  
 COMPOSITE BODY KOMPZYTOWY KORPUS 190 g



No.	Power / Moc [kW]	
73400	1.7	12

EN Gas soldering lamp  
 PL Gazowa lampa lutownicza  
 DE Gaslötlampe  
 RU Газовая паяльная лампа

CZ Plynová pájecí lampka  
 RO Lampă de lipit pe gaz  
 HU Gázos forrasztólámpa  
 ES Lampa de gas para soldar

1.7 kW PIEZO max °C 850 123 g/h GAS GAZ BUTANE BUTAN METAL BODY METALOWY KORPUS 190 g

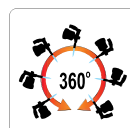

No.	Power / Moc [kW]	
73404	1.7	20

EN Panel clamps  
 PL Klamry do paneli ściennych  
 DE Klammern für Paneele  
 RU Крепеж для панелей  
 CZ Přichytky do panelů  
 RO Cleme lambriu  
 HU Kapcsok c panelekhez  
 ES Abrazaderas para paneles de paredes

100 PCS



No.	Type / Typ	pcs / szt.	
04720	C-3	100	50
04721	C-1	100	50

EN Gas soldering lamp  
 PL Gazowa lampa lutownicza  
 DE Gaslötlampe  
 RU Газовая паяльная лампа

CZ Plynová pájecí lampka  
 RO Lampă de lipit pe gaz  
 HU Gázos forrasztólámpa  
 ES Lampa de gas para soldar

1.7 kW PIEZO max °C 1200 123 g/h BUTANE BUTAN METAL BODY METALOWY KORPUS 190 g



No.	Power / Moc [kW]	
73403	1.7	12

EN Gas torch  
 PL Palnik gazowy  
 DE Gasbrenner  
 RU Газовая горелка  
 CZ Plynový hořák  
 RO Arzător de gaz  
 HU Gázégő  
 ES Soplete de gas

0.22 kW PIEZO max °C 1300 GAS GAZ BUTANE BUTAN LIGHTER GAS GAZ DO ZAPALNICZEK 10 g LOCK BLOKADA 30 min CHILDREN PROTECTION ZABEZPECZENIE PRZED DZIECIAMI 360°



No.	Power / Moc [kW]	
73420	0.22	10/60

EN Soldering tool 3 in 1  
 PL Lutownica gazowa 3 w 1  
 DE 3 in 1 Gaslötkolben  
 RU Газовый паяльник 3 в 1  
 CZ Plynová rajka 3 v 1  
 RO Ciocan de lipit cu gaz 3 in 1  
 HU Gaz-forrasztópaka 3 az 1  
 ES Soldador de gas 3 en 1

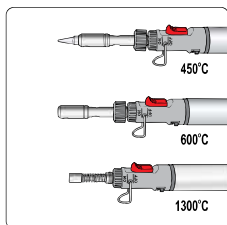

No.	Power / Moc [W]	
73410	25-80	12/48

EN Gas blow torch  
 PL Palnik gazowy  
 DE Lötbrenner  
 RU Газовая горелка  
 CZ Plynový hořák  
 RO Arzător de gaz  
 HU Gázégő  
 ES Soplete de gas

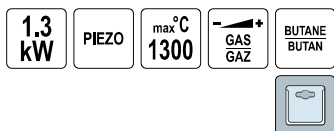

No.	Power / Moc [kW]	
73412	1.3	10/60

11



No.	Power / Moc [kW]	
73413	1.3	10/60

EN Point nozzle  
 PL Dysza do lutowania, płomień punktowy  
 DE Düse zum Löten, Punktflamme  
 RU Сопло паяльника  
 CZ Dýza na letování, bodový plamen  
 RO Duză pt. lipit, flacăără punct  
 HU Forrasztó égő, szűró láng  
 ES Tobera para soldadura, llama de punta

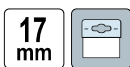

No.	Size / Rozmiar [mm]	
73330	17	50/250

EN Plumbers torch set with burners  
 PL Zestaw do lutowania z dyszami  
 DE Lötsatz  
 RU Набор для пайки  
 CZ Souprava k letování  
 RO Set pt. lipit  
 HU Forrasztó készlet  
 ES Juego para soldadura

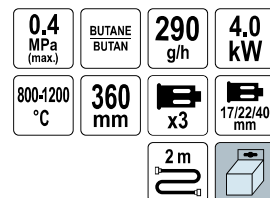

No.	Max. pressure / Maks. ciśnienie [MPa]	Power / Moc [kW]	L [mm]	
73325	0.4	4	360	20

EN Flat nozzle  
 PL Dysza do lutowania, płomień płaski  
 DE Düse zum Löten, flache Flamme  
 RU Сопло плоское  
 CZ Dýza na letování, plochý plamen  
 RO Duză pt. lipit, flacăără plată  
 HU Forrasztó égő, lapos láng  
 ES Tobera para soldadura, llama plana



No.	Size / Rozmiar [mm]	
73331	40	50/250

EN Roof heating torch with burners  
 PL Palnik dekarski z dyszami  
 DE Dachdeckerbrenner  
 RU Кровельная горелка  
 CZ Hořák pro pokrývče  
 RO Arzător pt. acoperiș  
 HU Bádógos forrasztó készülék  
 ES Soplete de techado



0.4 MPa (max.)	BUTANE BUTAN	930 g/h	13 kW	1500-1800 °C
360 mm	x3	25/35/50 mm	2 m	

**VOREL**

No.	Max. pressure / Maks. ciśnienie [MPa]	Power / Moc [kW]	L [mm]	
73340	0.4	13	360	10

EN Roof heating torch with burners  
 PL Palnik dekarski z dyszą i lancą  
 DE Dachdeckerbrenner  
 RU Кровельная горелка  
 CZ Hořák pro pokrývče  
 RO Arzător pt. acoperiș  
 HU Bádógos forrasztó készülék  
 ES Soplete de techado



0.4 MPa (max.)	BUTANE BUTAN	3420 g/h	47 kW	1500-1800 °C	745 mm
x1	50 mm	2 m			

**VOREL**

No.	Max. pressure / Maks. ciśnienie [MPa]	Power / Moc [kW]	L [mm]	
73341	0.4	47	745	20

EN Roof heating torch with burners  
 PL Palnik dekarski z dyszą i lancą  
 DE Dachdeckerbrenner  
 RU Кровельная горелка  
 CZ Hořák pro pokrývče  
 RO Arzător pt. acoperiș  
 HU Bádógos forrasztó készülék  
 ES Soplete de techado



0.25 MPa (max.)	BUTANE BUTAN	4465 g/h	62 kW	800-1200 °C	1315 mm
x1	60 mm	5 m			

**VOREL**

No.	Max. pressure / Maks. ciśnienie [MPa]	Power / Moc [kW]	L [mm]	
73342	0.25	62	1315	8

EN Roof heating torch with burners  
 PL Palnik dekarski z dyszami i lancą  
 DE Dachdeckerbrenner  
 RU Кровельная горелка  
 CZ Hořák pro pokrývče  
 RO Arzător pt. acoperiș  
 HU Bádógos forrasztó készülék  
 ES Soplete de techado



0.25 MPa (max.)	BUTANE BUTAN	5900 g/h	82 kW	1500-1800 °C	1385 mm
x2	60 mm	5 m			

**VOREL**

No.	Max. pressure / Maks. ciśnienie [MPa]	Power / Moc [kW]	L [mm]	
73343	0.25	82	1385	8

EN Weed burner  
 PL Palnik do wypalania chwastów  
 DE Unkrautbrenner  
 RU Горелка для выжигания сорняков  
 CZ Hořák na pleveľ  
 RO Arzător pt. buruieni  
 HU Gyomégető  
 ES Quemador de malezas



PIEZO	PROPANE BUTANE PROPAN BUTAN	226 g/h	3 kW	max °C 1300	7/16" 11 mm
850 mm	x1	25 mm			

**VOREL**

No.	Power / Moc [kW]	L [mm]	
73430	3	850	12



EN Nozzle  
 PL Dysza  
 DE Düse  
 RU Сопло  
 CZ Dýza  
 RO Duză  
 HU Fúvóka  
 ES Tobera



EN Hose  
 PL Wąż przyłączeniowy do gazu  
 DE Anschluss Schlauch für Gas  
 RU Шланг газоподводящий

CZ Hadice k připojení plynu  
 RO Furtun de conectare pt. gaz  
 HU Csatlakozó gáztömlő  
 ES Manguera de conexión de gas

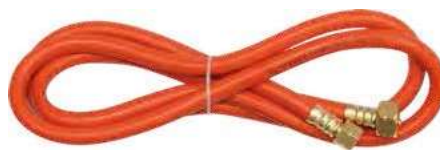

No.	Ø [mm]	
73350	25	50
73351	35	50
73352	50	50
73353	60	50



No.	L [m]	Ø [mm]	
73360	2	8	20
73362	5	8	10

EN Aluminium telescopic ladder  
 PL Aluminiowa drabina teleskopowa  
 DE Teleskopleiter aus Aluminium  
 RU Многофункциональная стремянка  
 CZ Hliníkový teleskopický žebřík  
 RO Scară telesopică din aluminiu  
 HU Alumínium kihúzható létra  
 ES Escalera telescópica de aluminio

max 3.8 m  
 13 STEPS STOPNE  
 max 150 kg  
 AI NYLON

max 3.8 m  
 13 STEPS STOPNE  
 max 150 kg  
 AI NYLON

FEATURES:

- Safe folding system according to newest EN 131-6 standard

- Safety lock

CECHY:

- Bezpieczny system składania zgodny z normą EN 131-6

- Blokada zabezpieczająca

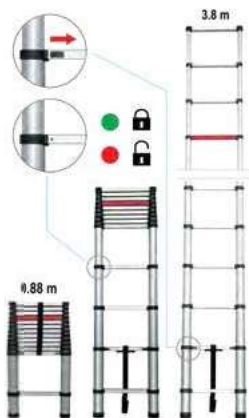

No.	Max. height / Maks. wysokość [m]	Rung quantity / Liczba stopni	
17701	3.8	13	1

EN Aluminium telescopic ladder  
 PL Aluminiowa drabina teleskopowa  
 DE Teleskopleiter aus Aluminium  
 RU Многофункциональная стремянка  
 CZ Hliníkový teleskopický žebřík  
 RO Scară telesopică din aluminiu  
 HU Alumínium kihúzható létra  
 ES Escalera telescópica de aluminio



No.	Max. height / Maks. wysokość [m]	Rung quantity / Liczba stopni	
17702	3.8	13	1

EN Multifold ladder  
 PL Drabina wielofunkcyjna  
 DE Mehrzweckleiter  
 RU Лестница многофункциональная  
 CZ Multifunkční žebřík  
 RO Scară multifuncțională  
 HU Többcéjú létra  
 ES Escalera multipropósito

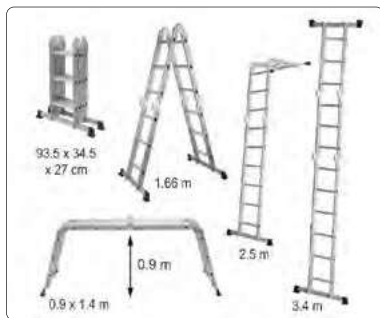

No.	Max. height / Maks. wysokość [m]	Rung quantity / Liczba stopni	
17704	3.4	4x3	1



max 3.4 m  
 4x3 STEPS STOPNE  
 16 kg  
 max 150 kg



EN 2-step ladder  
 PL Drabina 2-stopniowa rozkładana  
 DE 2-Stufen-Leiter  
 RU 2-ступенчатая лестница  
 CZ Schůdky 2 stupně  
 RO Scări cu 2 trepte  
 HU 2 fokos lépcsők  
 ES 2 pasos escaleras



90x47,5 x49 cm	h   99 cm FOLDED, ZLOZONA	2 STEPS STOPNIE
38x26 cm		max 150 kg
SOFT GRIP MIEKKI UCHWYT	PROTECTION RAIL WSPORNİK OCHRONNY	



No.	Height / Wysokość [m]	Rung quantity / Liczba stopni	
17730	0,9	2	4

EN Multifold ladder platform  
 PL Podest do drabiny wielofunkcyjnej  
 DE Podest für die Multifunktionale Leiter  
 RU Подставки для стремянки  
 CZ Plošina pro víceúčelový žebřík  
 RO Platformă pt. scară multifuncțională  
 HU Palló a multifunkciós létrához  
 ES Descansillos para la escala multifuncional

830x295 mm	560x295 mm	ZINC PLATED OCYNKO- WANA
ANTISLIP SURFACE POWIERZCHINIA ANTIPOŚLIZGWA	max 150 kg	



No.	For / Dla	
17705	17704	5

EN Saw horse  
 PL Podstawa robocza z metalu  
 DE Stahl-Arbeitsbock  
 RU Опорный штатив  
 CZ Opěrný kozlík  
 RO Capre de lucru  
 HU Munkabak  
 ES Caballete de apoyo

2 PCS	100x10 x75 cm	max 200 kg	NON SLIP WORKTOP BLAT ANTY- POŚLIZGOWY
GALVANIZED STEEL OCYNKOWANA	HOLDER FOR CARRYING UCHWYT DO PRZENOSZENIA		



No.	
29401	1

EN 3-step ladder  
 PL Drabina 3-stopniowa rozkładana  
 DE 3-Stufen-Leiter  
 RU 3-ступенчатая лестница  
 CZ Schůdky 3 stupně  
 RO Scări cu 3 trepte  
 HU 3 fokos lépcsők  
 ES 3 pasos escaleras



115x47,5 x65 cm	h   125 cm FOLDED, ZLOZONA	3 STEPS STOPNIE
38x26 cm		max 150 kg
SOFT GRIP MIEKKI UCHWYT	PROTECTION RAIL WSPORNİK OCHRONNY	



No.	Height / Wysokość [m]	Rung quantity / Liczba stopni	
17733	1,15	3	2

EN Saw horse  
 PL Podstawa robocza z tworzywa  
 DE Stahl-Arbeitsbock  
 RU Опорный штатив  
 CZ Opěrný kozlík  
 RO Capre de lucru  
 HU Munkabak  
 ES Caballete de apoyo

2 PCS	PP	ABS	TPR	
----------	----	-----	-----	--



No.	
29400	3

EN Saw horse  
 PL Podstawa robocza z regulowaną wysokością  
 DE Stahl-Arbeitsbock  
 RU Опорный штатив  
 CZ Opěrný kozlík  
 RO Capre de lucru  
 HU Munkabak  
 ES Caballete de apoyo

130 79 mm	max 200 kg	GALVANIZED STEEL OCYNKOWANA	HOLDER FOR CARRYING UCHWYT DO PRZENOSZENIA	
-----------------	---------------	-----------------------------------	---	--



No.	
29404	1

EN Adjustable roller stand  
 PL Podpora z rolką  
 DE Rollenbock  
 RU Поликовая опора  
 CZ Opěrný stojan  
 RO Stand cu role si suport  
 HU Felsőgörgős-bak  
 ES Caballete de apoyo con rodillo



105  
68 mm

60cm  
ROLLER  
ROLKA

max  
60 kg

GALVANIZED  
STEEL  
STAL  
OCYNKOWANA

CHROME  
ROLLER  
CHROMOWANA  
ROLKA



No.		
29410		1

EN Telescopic support bar  
 PL Podpora teleskopowa  
 DE Baustütze-Schnellspannstütze  
 RU Подъемник-распорка для гипсокартона  
 CZ Tyč teleskopická rozpěrná  
 RO Suport sustinere telescopic  
 HU Teleszkópos támasztórúd  
 ES Puntal expansion



115  
50 cm

max  
30 kg



No.		
29440		2/10

EN Telescopic support bar  
 PL Podpora teleskopowa  
 DE Baustütze-Schnellspannstütze  
 RU Подъемник-распорка для гипсокартона  
 CZ Tyč teleskopická rozpěrná  
 RO Suport sustinere telescopic  
 HU Teleszkópos támasztórúd  
 ES Puntal expansion



290  
115 cm

max  
30 kg



No.		
29444		2/10

EN Telescopic support bar  
 PL Podpora teleskopowa  
 DE Baustütze-Schnellspannstütze  
 RU Подъемник-распорка для гипсокартона  
 CZ Tyč teleskopická rozpěrná  
 RO Suport sustinere telescopic  
 HU Teleszkópos támasztórúd  
 ES Puntal expansion



290  
160 cm

max  
60 kg



No.		
29445		4/8

EN Trowel  
 PL Paca  
 DE Reibebrett  
 RU Терка  
 CZ Hladitko  
 RO Gletieră  
 HU Glettelő  
 ES Llana



No.	Size / Rozmiar [mm]	
06400	130x270	10
06410	140x500	10
06440	170x320	10

EN Trowel  
 PL Paca  
 DE Reibebrett  
 RU Терка  
 CZ Hladitko  
 RO Gletieră  
 HU Glettelő  
 ES Llana



No.	Size / Rozmiar [mm]	
06420	140x700	10
06430	140x1000	10

EN Trowel  
PL Paca  
DE Reibebrett  
RU Терка  
CZ Hladitko  
RO Gletieră  
HU Glettelő  
ES Llana

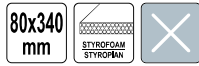

No.	Size / Rozmiar [mm]	
06401	80x340	10

EN Trowel  
PL Paca  
DE Reibebrett  
RU Терка  
CZ Hladitko  
RO Gletieră  
HU Glettelő  
ES Llana

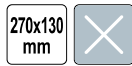

No.	Size / Rozmiar [mm]	
06500	270x130	24

EN Trowel  
PL Paca  
DE Reibebrett  
RU Терка  
CZ Hladitko  
RO Gletieră  
HU Glettelő  
ES Llana



No.	Size / Rozmiar [mm]	Rubber thickness / Grubość gumy [mm]	
06520	270x130	4	30

EN Trowel  
PL Paca  
DE Reibebrett  
RU Терка  
CZ Hladitko  
RO Gletieră  
HU Glettelő  
ES Llana



No.	Size / Rozmiar [mm]	Sponge thickness / Grubość gąbki [mm]	
06540	270x130	25	20

EN Rasp for polystyrene  
PL Tarka do styropianu  
DE Reibebrett für Styropor  
RU Терка для пенопласта  
CZ Rašple na polystyren  
RO Gletieră pt. răzuit polistiren  
HU Polisztirol reszelő  
ES Escofina para poliestireno



No.	Size / Rozmiar [mm]	
06470	270x130	20
06472	400x180	10

EN Trowel  
PL Paca  
DE Reibebrett  
RU Терка  
CZ Hladitko  
RO Gletieră  
HU Glettelő  
ES Llana



No.	Size / Rozmiar [mm]	
06510	270x130	20

EN Trowel  
PL Paca  
DE Reibebrett  
RU Терка  
CZ Hladitko  
RO Gletieră  
HU Glettelő  
ES Llana



No.	Size / Rozmiar [mm]	Sponge thickness / Grubość gąbki [mm]	
06530	270x130	25	20



EN Trowel  
 PL Paca  
 DE Reibebrett  
 RU Tepka  
 CZ Hladitko  
 RO Gletieră  
 HU Glettelő  
 ES Llana



No.	Size / Rozmiar [mm]	
06640	380x128	10
06660	480x128	10
06680	580x128	18

EN Trowel  
 PL Paca  
 DE Reibebrett  
 RU Tepka  
 CZ Hladitko  
 RO Gletieră  
 HU Glettelő  
 ES Llana



No.	Size / Rozmiar [mm]	Teeth size / Rozmiar zębów [mm]	
06650	380x128	8x8	10
06670	480x128	8x8	10
06690	580x128	8x8	18

EN Trowel  
 PL Paca  
 DE Reibebrett  
 RU Tepka  
 CZ Hladitko  
 RO Gletieră  
 HU Glettelő  
 ES Llana



No.	Size / Rozmiar [mm]	
06700	270x125	24

EN Trowel  
 PL Paca  
 DE Reibebrett  
 RU Tepka  
 CZ Hladitko  
 RO Gletieră  
 HU Glettelő  
 ES Llana



No.	Size / Rozmiar [mm]	
06701	270x130	24

EN Trowel  
 PL Paca  
 DE Reibebrett  
 RU Tepka  
 CZ Hladitko  
 RO Gletieră  
 HU Glettelő  
 ES Llana



No.	Size / Rozmiar [mm]	Teeth size / Rozmiar zębów [mm]	
06740	270x125	4x4	24
06760	270x125	6x6	24
06780	270x125	8x8	24
06781	270x125	10x10	24



EN Trowel  
 PL Paca  
 DE Reibebrett  
 RU Tepka  
 CZ Hladitko  
 RO Gletieră  
 HU Glettelő  
 ES Llana



No.	Size / Rozmiar [mm]	
06512	280x95	12

EN Trowel  
 PL Paca  
 DE Reibebrett  
 RU Tepka  
 CZ Hladitko  
 RO Gletieră  
 HU Glettelő  
 ES Llana



No.	Size / Rozmiar [mm]	Sponge thickness / Grubość gąbki [mm]	
06532	270x130	30	20

EN Trowel  
PL Paca  
DE Reibebrett  
RU Терка  
CZ Hladítko  
RO Gletieră  
HU Glettelő  
ES Llana



No.	Size / Rozmiar [mm]	Rubber thickness / Grubość gumy [mm]	
06537	270x130	9	20
06538	270x130	18	20

EN Trowel  
PL Kielnia  
DE Kelle  
RU Кельма  
CZ Lžíce  
RO Mistrie  
HU Vakolókanál  
ES Paleta



No.	Size / Rozmiar [mm]	
06341	180	50
06351	200	30

EN Trowel  
PL Kielnia  
DE Kelle  
RU Кельма

CZ Lžíce  
RO Mistrie  
HU Vakolókanál  
ES Paleta



No.	Size / Rozmiar [mm]	
06109	40x110	50
06110	60x110	50
06120	80x120	50
06121	100x120	50

EN Plaster / stucco spray gun  
PL Tynkownica pneumatyczna do ścian  
DE Spritzpistole für Mörtel  
RU Пневмоковш для штукатурки стен  
CZ Stříkací pistole pro maltu  
RO Spray pistol pt. mortar  
HU Habarcs szórópisztoly  
ES Pistola pulverizadora para mortero

0.4-0.6 MPa    400 l/min    4L    max 50 m<sup>3</sup>/h    STANDARD



$L_{pA} = 91,8 \pm 2,5 \text{ dB}$ ;  $L_{wA} = 102,8 \pm 2,5 \text{ dB}$ ;  $a_n = < 2,5 \text{ m/s}^2$

No.	Required air flow / Wymagany przepływ powietrza [l/min]	
09900	350-400	4

EN Trowel  
PL Kielnia  
DE Kelle  
RU Кельма  
CZ Lžíce  
RO Mistrie  
HU Vakolókanál  
ES Paleta



No.	Size / Rozmiar [mm]	
06340	180	50
06350	200	50
06360	220	50

EN Trowel  
PL Kielnia  
DE Kelle  
RU Кельма  
CZ Lžíce  
RO Mistrie  
HU Vakolókanál  
ES Paleta



No.	Size / Rozmiar [mm]	
06370	130	50
06380	180	30

EN Ceiling plaster / stucco spray gun  
PL Tynkownica pneumatyczna do sufitów  
DE Deckenplatte / Stucco Spritzpistole  
RU Пневмоковш для штукатурки потолков  
CZ Stříkací pistole pro maltu  
RO Spray pistol pt. mortar  
HU Habarcs szórópisztoly  
ES Pistola pulverizadora para mortero

0.4-0.6 MPa    400 l/min    4L    max 50 m<sup>3</sup>/h    STANDARD



$L_{pA} = 94,9 \pm 2,5 \text{ dB}$ ;  $L_{wA} = 105,9 \pm 2,5 \text{ dB}$ ;  $a_n = < 2,5 \text{ m/s}^2$

No.	Required air flow / Wymagany przepływ powietrza [l/min]	
09903	350-400	4

- EN Hand wall coating sprayer
- PL Narzutnica tynku
- DE Verputzmaschine
- RU Металель штукатурки
- CZ Omítacíka
- RO Pulverizator manual pt. pereti
- HU Vakolatszóró
- ES Máquina de revestimiento de yeso

210x170  
mm



No.	Size / Rozmiar [mm]	
09910	210x170	12

- EN Aerated concrete drill
- PL Wiertło do gazobetonu
- DE Bohrer für Porenbeton
- RU Сверло по газобетону
- CZ Vrták do pórobetonu
- RO Burghiu pt. BCA
- HU Pórusbeton fúró
- ES Broca para hormigón celular

GALVANIZED  
STEEL  
STAL  
OCYNKOWANA



No.	Working width / Szerokość robocza [mm]	
05821	80	20
05822	80	20
05823	120	20

- EN Scraper
- PL Zdzierak
- DE Raspelhobel
- RU Рубанок
- CZ Škrabák
- RO Gletieră
- HU Vakolatgyalu
- ES Raspador

80x400  
mm

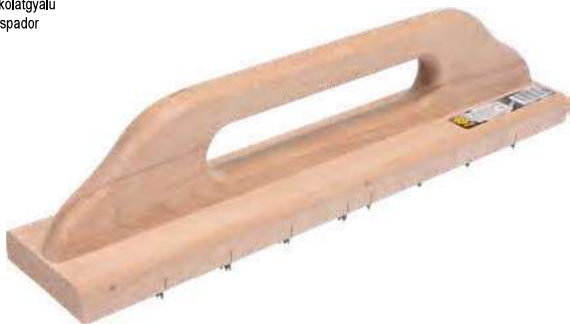

No.	Size / Rozmiar [mm]	
05831	80x400	10

- EN Aerated concrete trowel
- PL Kielnia do gazobetonu
- DE Kelle für Porenbeton
- RU Кельма для газобетона
- CZ Zednická lžice na pórobeton
- RO Mistrie pt. BCA
- HU Simitó pórusbetonhoz
- ES Paleta para hormigón celular



No.	Size / Rozmiar [mm]	
05801	100	10
05802	115	10
05803	125	10
05804	200	10
05805	240	10

- EN Scraper
- PL Zdzierak
- DE Raspelhobel
- RU Рубанок
- CZ Škrabák
- RO Gletieră
- HU Vakolatgyalu
- ES Raspador

80x400  
mm



No.	Size / Rozmiar [mm]	
05830	80x400	10

- EN Guide for aircrete blocks
- PL Przymiar do gazobetonu
- DE Sägewinkel für Porenbeton
- RU Угольник для резки газобетона
- CZ Úhelník na pórobeton
- RO Suport pt. tăiere BCA
- HU Pórusbeton sablon
- ES Guía para hormigón celular



No.		
05840		4

- EN Groove scraper
- PL Rylec
- DE Nutenschaber
- RU Штроборез
- CZ Drážkovač
- RO Unealta canelat BCA
- HU Horonyvágó
- ES Acanalador



No.		
05850		10

- EN Panel carry
- PL Nosidło do płyt gipsowo-kartonowych
- DE Plattenträger mit Tragegriff
- RU Приспособление для переноски плит
- CZ Držák pro přenášení desek s rukojetí
- RO Dispozitiv pt. transportat plac de gips-carton
- HU Gipszkarton hordó
- ES Porta-panels



No.	Dimensions / Wymiary [mm]	
04756	560x140x190	10

- EN Scraper
- PL Szpachelka
- DE Malerspachtel
- RU Шпатель
- CZ Špachtle
- RO Șpachli
- HU Spatula
- ES Espatula



No.	Working width / Szerokość robocza [mm]	
06030	30	12/240
06040	40	12/240
06050	50	12/240
06060	60	12/240
06080	80	12/240
06100	100	12/240

- EN Drywall panel carrier
- PL Uchwyt do przenoszenia płyt gipsowo-kartonowych
- DE Plattenträger mit Tragegriff
- RU Приспособление для переноски плит
- CZ Držák pro přenášení desek s rukojetí
- RO Dispozitiv pt. transportat plac de gips-carton
- HU Jellemzők és előnyök
- ES Empunadura porta-placas

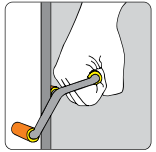

No.		
04755		6/12

- EN Drywall stripper
- PL Obcinak dwustronny do płyt gipsowo-kartonowych
- DE Streifenschneider
- RU Рейсмус-резаk для гипсокартона
- CZ Řezák na sádrokarton
- RO Dispozitiv reglabil de taiere a placilor de gips-carton
- HU Gipszkarton vágó
- ES Cortador de tiras para tablaroca

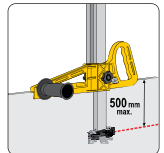
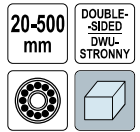

No.	Cutting width / Szerokość cięcia [mm]	
04770	20-500	10

- EN Scraper set
- PL Zestaw szpachelek
- DE Malerspachtelsatz
- RU Набор шпателей
- CZ Špachtle
- RO Șpachli
- HU Spatula
- ES Espatulas



No.	Working width / Szerokość robocza [mm]	pcs / szt.	
06130	30, 50, 80	3	25/100

EN Corner trowel  
 PL Szpachelka kątowna  
 DE Necken-Kelle  
 RU Кельма угловая  
 CZ Úhlová špachtle  
 RO Șpaclu colț  
 HU Kanál sarok  
 ES Paleta ángulo



No.	Dimensions / Wymiary [mm]	
06140	80x60x60	50

EN Plastic japanese putty knives  
 PL Szpachle japońskie plastikowe  
 DE Kunststoff Japan-Spachtel-Set  
 RU Пластиковые шпатели «японки»  
 CZ Špachtle japonské plastové  
 RO Set spaclu japoneze plastic  
 HU Japán spakli készlet műanyag  
 ES Juego de espátulas japonesas de plástico



No.	Working width / Szerokość robocza [mm]	pcs / szt.	
05950	50, 80, 100, 120	4	10

EN Stainless steel putty knife  
 PL Szpachla nierdzewna  
 DE Edelstahl-Kleberspachtel  
 RU Шпатель фасадный нержавеющей  
 CZ Nerezová špachtle  
 RO Spaclu inox pt. chituit  
 HU Rozsdamentes spakli  
 ES Espátula de acero inoxidable



No.	Working width / Szerokość robocza [mm]	
06294	40	100
06295	60	80
06296	80	60
06297	100	50
06298	150	80
06301	200	60
06304	250	50
06307	350	25
06308	450	25
06309	600	10

EN Corner trowel  
 PL Szpachelka kątowna  
 DE Necken-Kelle  
 RU Кельма угловая  
 CZ Úhlová špachtle  
 RO Șpaclu colț  
 HU Kanál sarok  
 ES Paleta ángulo



No.	Dimensions / Wymiary [mm]	
06150	80x60x60	50

EN Stainless steel scraper set  
 PL Szpachelki nierdzewne «japonki»  
 DE Aufstreichspachtel  
 RU Набор шпателей тип «Японский»  
 CZ Špachtle japonsky nerezavějící  
 RO Spaclu japoneze inoxidabile  
 HU Spatula rozsdamentes  
 ES Espátulas «japonesas» de acero

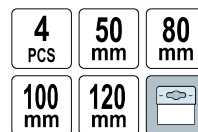

No.	Working width / Szerokość robocza [mm]	pcs / szt.	
06290	50, 80, 100, 120	4	12/120

EN Stainless steel putty knife  
 PL Szpachla nierdzewna  
 DE Edelstahl-Kleberspachtel  
 RU Шпатель фасадный нержавеющей  
 CZ Nerezová špachtle  
 RO Spaclu inox pt. chituit  
 HU Rozsdamentes spakli  
 ES Espátula de acero inoxidable



No.	Working width / Szerokość robocza [mm]	Teeth size / Rozmiar zębów [mm]	
06299	150	6x6	80
06300	150	8x6	80
06302	200	6x6	60
06303	200	8x8	60
06305	250	6x6	50
06306	250	8x8	50

EN Finishing spatula  
 PL Szpachla wykończeniowa  
 DE Flächenspachtel  
 RU Финишный шпатель

CZ Špachtle fasádní  
 RO Gletieră finisare  
 HU Glett lehűző  
 ES Espátula para alisado



No.	Working width / Szerokość robocza [mm]	
06001	250	24
06002	400	12
06003	600	12
06004	800	12
06005	1000	8
06006	1200	8

EN Plastic putty knives for glue  
 PL Pące plastikowe do kleju  
 DE Kunststoffspachtel gezahnt  
 RU Пластиковые шпатели для плиточного клея  
 CZ Zubová stěrka plastová  
 RO Spaclu din plastic  
 HU Műanyag spáklí  
 ES Espátula de plástico



No.	Dimensions / Wymiary [mm]	pcs / szt.	
05960	180x130, 130x90	2	10

EN Plastic putty knife  
 PL Szpachla plastikowa  
 DE Kunststoffspachtel  
 RU Шпатель пластмассовый  
 CZ Plastová špachtle  
 RO Spaclu din plastic  
 HU Műanyag spáklí  
 ES Espátula de plástico



No.	Working width / Szerokość robocza [mm]	Teeth size / Rozmiar zębów [mm]	
05972	225	6x6	50

EN Replaceable blade for finishing spatula  
 PL Ostrze do szpachli wykończeniowej  
 DE Ersatzblatt für Flächenspachtel  
 RU Лезвие для финишного шпателя  
 CZ Náhradní čepel do špachtle fasádní  
 RO Lamă de înlocuit pt. gletieră finisare  
 HU Cserélhető penge glett lehűzőhöz  
 ES Cuchilla de recambio para espátula de alisado



No.	W [mm]	For / Dla	
06010	250	06001	160
06011	400	06002	160
06012	600	06003	160
06013	800	06004	80
06014	1000	06005	80
06015	1200	06006	80

EN Plastic putty knife  
 PL Szpachla plastikowa  
 DE Kunststoffspachtel  
 RU Шпатель пластмассовый  
 CZ Plastová špachtle  
 RO Spaclu din plastic  
 HU Műanyag spáklí  
 ES Espátula de plástico



No.	Working width / Szerokość robocza [mm]	
05971	225	50

EN Plastic putty knife  
 PL Szpachla plastikowa  
 DE Kunststoffspachtel  
 RU Шпатель пластмассовый  
 CZ Plastová špachtle  
 RO Spaclu din plastic  
 HU Műanyag spáklí  
 ES Espátula de plástico



No.	Working width / Szerokość robocza [mm]	Teeth size / Rozmiar zębów [mm]	
05973	225	7	50

EN Plastic putty knife set  
 PL Szpachle plastikowe  
 DE Kunststoff-Spachtel-Set  
 RU Шпатели пластиковые  
 CZ Plastové špachtle  
 RO Set spachu plastic  
 HU Spakli készlet műanyag  
 ES Espátulas de plástico

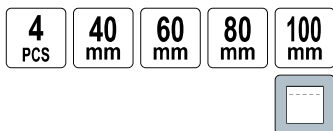

No.	Working width / Szerokość robocza [mm]	pcs / szt.	
05980	40, 60, 80, 100	4	30

EN Flexible silicone and sealant smother  
 PL Gładzik do silikonu  
 DE Silikonglätter  
 RU Шпатель для затирки силикона  
 CZ Hladítko do silikonu  
 RO Dispozitiv pt. silicon si mastic  
 HU Szilikon lehúzó  
 ES Alisador de juntas de silicona



No.	L [mm]	
04360	150	24/240

EN Stainless steel scraper  
 PL Szpachelka nierdzewna  
 DE Rostfrei Spachtel  
 RU Шпатель нержавеющей  
 CZ Špachtle  
 RO Șpachlu  
 HU Spatula  
 ES Espátula de acero inox



No.	Working width / Szerokość robocza [mm]	
05911	30	6/72
05912	40	6/72
05913	50	6/72
05914	60	6/72
05915	80	6/72
05916	100	6/72

EN Rubber putty knife  
 PL Szpachla gumowa  
 DE Gummispachtel  
 RU Шпатель резиновый  
 CZ Gumová špachtle  
 RO Șpachlu cauciuc  
 HU Fugázó gumi  
 ES Espátula de goma



No.	Working width / Szerokość robocza [mm]	
06310	150	30
06320	200	30
06330	250	30
06331	300	30

EN Stainless steel scraper  
 PL Szpachelka nierdzewna  
 DE Rostfrei Spachtel  
 RU Шпатель нержавеющей

CZ Špachtle  
 RO Șpachlu  
 HU Spatula  
 ES Espátula de acero inox



No.	Working width / Szerokość robocza [mm]	
05901	30	6/72
05902	40	6/72
05903	50	6/72
05904	60	6/72
05905	80	6/72
05906	100	6/72

EN Stainless steel scraper  
 PL Szpachelka nierdzewna wygięta  
 DE Rostfrei Spachtel  
 RU Шпатель нержавеющей изогнутый  
 CZ Špachtle  
 RO Șpachlu  
 HU Spatula  
 ES Espátula de acero inox curvo



No.	Working width / Szerokość robocza [mm]	
05921	30	6/72
05922	40	6/72
05923	50	6/72
05924	60	6/72
05925	80	6/72
05926	100	6/72

EN Painting scraper  
 PL Skrobak malarski  
 DE Malerabkratzer  
 RU Скребок для краски со сменным лезвием  
 CZ Škrabka malířská  
 RO Răzuitor pt. zugrăvi  
 HU Festékvakaró  
 ES Rascador de pintor



No.	Blade working width / Szerokość robocza ostrza [mm]	
06795	100	60

EN Spare blades for painting scraper  
 PL Ostrze do skrobaka  
 DE Schneide für Malerabkratzer  
 RU Сменные лезвия для скребка  
 CZ Ostrří do škrabky  
 RO Taiș pt. răzuitor  
 HU Festékvakaró-pengék  
 ES Fila para rascador



No.	For / Dla	
06796	06795	10/100

EN Scraper for concrete floor  
 PL Skrobak do betonu z trzonkiem  
 DE Betonschaber  
 RU Скребок напольный для бетона  
 CZ Škrabka  
 RO Răzuitor  
 HU Kaparó  
 ES Raspador obra suel



No.	Blade size / Rozmiar ostrza [mm]	L [mm]	
05750	75x200	1300	10
05751	75x300	1300	10
05752	75x400	1300	10

EN Blade for scraper  
 PL Wymienne ostrze do skrobaka do betonu  
 DE Klinge für Betonschaber  
 RU Лезвие к скребку для бетонного пола  
 CZ Škrabka vyměnitelná čepel  
 RO Lamă de schimb  
 HU Kaparó cserélhető penge  
 ES Răzuitor lamă de schimb



No.	Blade size / Rozmiar ostrza [mm]	
05770	100x200	25/50
05771	100x300	25/50
05772	100x400	25/50

EN Painting scraper  
 PL Skrobak malarski  
 DE Malerabkratzer  
 RU Скребок для краски  
 CZ Škrabka malířská  
 RO Răzuitor pt. zugrăvi  
 HU Festékvakaró  
 ES Rascador de pintor



No.	Working width / Szerokość robocza [mm]	
06797	115	50

EN Telescopic scraper  
 PL Skrobak teleskopowy  
 DE Teleskop Schaber  
 RU Скребок телескопический  
 CZ Teleskopický stěrač  
 RO Răzuitor flexibil  
 HU Teleszkópos jégkaparó  
 ES Telescópico raspador



No.		
06799		16/96

EN Scraper for concrete floor  
 PL Skrobak do betonu bez trzonka  
 DE Betonschaber  
 RU Скребок напольный для бетона  
 CZ Škrabka  
 RO Răzuitor  
 HU Kaparó  
 ES Raspador obra suel



No.	Blade size / Rozmiar ostrza [mm]	
05760	120x350	12/24
05761	120x250	12/24

EN Blade for scraper  
 PL Wymienne ostrze do skrobaka do betonu  
 DE Klinge für Betonschaber  
 RU Лезвие к скребку для бетонного пола  
 CZ Škrabka vyměnitelná čepel  
 RO Lamă de schimb  
 HU Kaparó cserélhető penge  
 ES Răzuitor lamă de schimb



No.	Blade size / Rozmiar ostrza [mm]	
05773	150x250	25/50
05774	150x350	25/50

EN Mason's pan  
 PL Czerpak murarski  
 DE Gipspfänchen  
 RU Ковш штукатурный  
 CZ Zednický koresek  
 RO Cancioc  
 HU Kőműveskanál  
 ES Achicador de albanil



No.	Quantity
06335	50

EN Mixer  
 PL Mieszadło  
 DE Rührer  
 RU Мешалка

CZ Michadlo  
 RO Mixer  
 HU Keverő  
 ES Mezclador



No.	Ø [mm]	L [mm]	Quantity
09060	60	400	40/80
09080	85	400	40/80
09090	100	600	30

EN Mixer  
 PL Mieszadło  
 DE Rührer  
 RU Мешалка

CZ Michadlo  
 RO Mixer  
 HU Keverő  
 ES Mezclador



No.	Ø [mm]	L [mm]	Quantity
09010	90	510	40

EN Mixer  
 PL Mieszadło  
 DE Rührer  
 RU Мешалка

CZ Michadlo  
 RO Mixer  
 HU Keverő  
 ES Mezclador



No.	Ø [mm]	L [mm]	Type / Typ	Quantity
09025	75	370	C-75	20

EN Building strainer  
 PL Sito budowlane  
 DE Bau Sieb  
 RU Сито строительное  
 CZ Prohazovací sito stavebni  
 RO Sita construcții  
 HU Építőipari rosta  
 ES Cedazo para construcción



No.	Dimensions / Wymiary [cm]	Eyelet size / Rozmiar oczka [mm]	Quantity
34944	60x100	4	30
34945	60x100	6	5/30
34946	60x100	8	5/30
34947	60x100	10	30

EN Mixer  
 PL Mieszadło  
 DE Rührer  
 RU Мешалка  
 CZ Michadlo  
 RO Mixer  
 HU Keverő  
 ES Mezclador



No.	Ø [mm]	L [mm]	Quantity
09005	65	410	40
09006	80	410	40

EN Mixer  
 PL Mieszadło  
 DE Rührer  
 RU Мешалка

CZ Michadlo  
 RO Mixer  
 HU Keverő  
 ES Mezclador



No.	Ø [mm]	L [mm]	Quantity
09015	65	400	40
09017	100	550	20

EN Mixer  
 PL Mieszadło  
 DE Rührer  
 RU Мешалка

CZ Michadlo  
 RO Mixer  
 HU Keverő  
 ES Mezclador



No.	Ø [mm]	L [mm]	Quantity
09031	75	300	10

EN Mixer  
PL Mieszadło  
DE Rührer  
RU Мешалка  
CZ Michadlo  
RO Mixer  
HU Keverő  
ES Mezclador



No.	Ø [mm]	L [mm]	
09044	80	400	25
09046	100	600	25

EN Mixer CZ Michadlo  
PL Mieszadło RO Mixer  
DE Rührer HU Keverő  
RU Мешалка ES Mezclador



No.	Ø [mm]	L [mm]	
09036	60	400	60
09038	80	400	35
09040	100	600	30

EN Mixer CZ Michadlo  
PL Mieszadło RO Mixer  
DE Rührer HU Keverő  
RU Мешалка ES Mezclador



**VOREL**

No.	Ø [mm]	L [mm]	
09096	80	400	20
09097	100	500	20

EN Mixer CZ Michadlo  
PL Mieszadło RO Mixer  
DE Rührer HU Keverő  
RU Мешалка ES Mezclador



No.	Ø [mm]	L [mm]	
09063	115	580	10
09065	135	580	10

EN Mixer CZ Michadlo  
PL Mieszadło RO Mixer  
DE Rührer HU Keverő  
RU Мешалка ES Mezclador



No.	Ø [mm]	L [mm]	Type / Typ	
09048	75	400	C-75	20
09049	85	450	C-85	20
09050	100	500	C-100	20
09051	110	550	C-110	20

EN Mixer CZ Michadlo  
PL Mieszadło RO Mixer  
DE Rührer HU Keverő  
RU Мешалка ES Mezclador



No.	Ø [mm]	L [mm]	Type / Typ	
09094	120	600	C-120	10

EN Mixer CZ Michadlo  
PL Mieszadło RO Mixer  
DE Rührer HU Keverő  
RU Мешалка ES Mezclador



**VOREL**

No.	Ø [mm]	L [mm]	
09077	80	500	10

EN Mixer CZ Michadlo  
PL Mieszadło RO Mixer  
DE Rührer HU Keverő  
RU Мешалка ES Mezclador

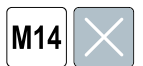

**VOREL**

No.	Ø [mm]	L [mm]	
09062	100	500	20

EN Wallpaper perforator  
 PL Walek do perforacji tapet  
 DE Tapetenperforierwalze  
 RU Валик для перфорации обоев  
 CZ Perforační váleček na tapety  
 RO Perforator de tapet  
 HU Tapétaperforáló henger  
 ES Rodillo para perforación de papel de pared



VOREL

No.	W [mm]	
06457	150	6/36

EN Deaeration roller  
 PL Walek do odpowietrzania  
 DE Entlüftungsrolle  
 RU Валик аэрационный  
 CZ Váleček na odvzdušňování  
 RO Rola pt. modelare sapa  
 HU Levegőkinyomó henger  
 ES Rodillo para hacer el vacío



VOREL

No.	Size / Rozmiar [mm]	
06450	75x230	15
06452	123x230	10

EN Plaster roller  
 PL Walek do gładzi gipsowych  
 DE Rollspachtel-Walze  
 RU Валик для шпаклевки  
 CZ Váleček na sádrovou omítku  
 RO Trafalet  
 HU Glettelő henger  
 ES Rodillo para masillar

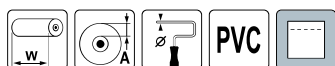

VOREL

No.	W [mm]	A [mm]	Ø [mm]	
09445	230	55	6	48

EN Handy paint roller  
 PL Walek malarski ze zbiornikiem na farbę  
 DE Malerrolle mit Farbbehälter  
 RU Малярный валик с емкостью для краски  
 CZ Malářský váleček s nádobou na barvu  
 RO Trafalet cu rezervor  
 HU Festőhenger festékadagoló tartállyal  
 ES Rodillo de pintura con depósito

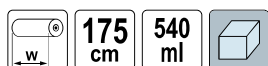

VOREL

No.	W [mm]	L [mm]	
09397	230	1750	6

EN Squeegee for wallpapers  
 PL Rakiel do tapet  
 DE Tapetenrakiel  
 RU Ракель для обоев  
 CZ Škrabka na tapety  
 RO Racleta pt. tapet  
 HU Tapétalenyomó  
 ES Rasqueta para papel de pared



VOREL

No.	Size / Rozmiar [mm]	
06460	280x165	12/120

EN Deaeration roller  
 PL Walek do odpowietrzania  
 DE Entlüftungsrolle  
 RU Валик аэрационный

CZ Váleček na odvzdušňování  
 RO Rola pt. modelare sapa  
 HU Levegőkinyomó henger  
 ES Rodillo para hacer el vacío



VOREL

No.	Size / Rozmiar [mm]	
06453	110x500	2

EN Plaster roller replacement  
 PL Zapasowy walek do gładzi gipsowych  
 DE Rollspachtel-Ersatzwalze  
 RU Запасной валик для шпаклевки  
 CZ Náhradní váleček na sádrovou omítku  
 RO Rezerva trafalet  
 HU Glettelő henger fej  
 ES Recambio rodillo para masillar



VOREL

No.	W [mm]	A [mm]	Ø [mm]	For / Dla	
09446	230	55	6	09445	50

EN Paint roller refill  
 PL Zapas do walika  
 DE Ersatz Farbrolle  
 RU Шубка для валика  
 CZ Náhradní váleček  
 RO Rezerva trafalet  
 HU Pót festőhenger  
 ES Recambio de rodillo



VOREL

No.	W [mm]	For / Dla	
09398	230	09397	100

EN Paint roller  
 PL Walek malarski  
 DE Farbroller  
 RU Валик в сборе  
 CZ Malířský váleček  
 RO Trafalet cu tijă  
 HU Festőhenger  
 ES Rodillo de pintura

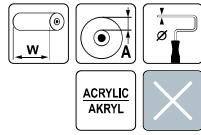

**VOREL**

No.	W [mm]	A [mm]	Ø [mm]	
09307	180	20	6	55
09308	250	20	6	50

EN Paint roller  
 PL Walek malarski  
 DE Farbroller  
 RU Валик в сборе  
 CZ Malířský váleček  
 RO Trafalet cu tijă  
 HU Festőhenger  
 ES Rodillo de pintura

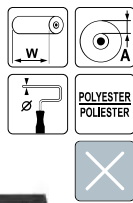

**VOREL**

No.	W [mm]	A [mm]	Ø [mm]	
09345	180	15	6	55
09346	250	15	6	50

EN Paint roller  
 PL Walek malarski  
 DE Farbroller  
 RU Валик в сборе

CZ Malířský váleček  
 RO Trafalet cu tijă  
 HU Festőhenger  
 ES Rodillo de pintura

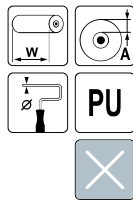

**VOREL**

No.	W [mm]	A [mm]	Ø [mm]	
09370	50	35	6	70

EN Paint roller refill  
 PL Zapas do walka  
 DE Ersatz Farbrolle  
 RU Шубка для валика

CZ Náhradní váleček  
 RO Rezerva trafalet  
 HU Pót festőhenger  
 ES Recambio de rodillo



**VOREL**

No.	W [mm]	A [mm]	Ø [mm]	
09302	180	15	6	40
09303	250	15	8	25

EN Paint roller  
 PL Walek malarski  
 DE Farbroller  
 RU Валик в сборе  
 CZ Malířský váleček  
 RO Trafalet cu tijă  
 HU Festőhenger  
 ES Rodillo de pintura

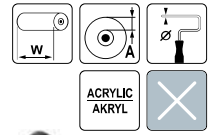

**VOREL**

No.	W [mm]	A [mm]	Ø [mm]	
09334	100	9	6	40
09336	180	18	6	60

EN Paint roller  
 PL Walek malarski  
 DE Farbroller  
 RU Валик в сборе  
 CZ Malířský váleček  
 RO Trafalet cu tijă  
 HU Festőhenger  
 ES Rodillo de pintura

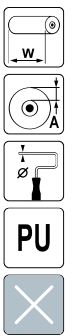

**VOREL**

No.	W [mm]	A [mm]	Ø [mm]	
09359	150	50	6	50

EN Paint roller  
 PL Walek malarski  
 DE Farbroller  
 RU Валик в сборе  
 CZ Malířský váleček  
 RO Trafalet cu tijă  
 HU Festőhenger  
 ES Rodillo de pintura



**VOREL**

No.	W [mm]	A [mm]	Ø [mm]	
09371	70	35	6	80
09372	100	35	6	70
09373	150	50	6	50

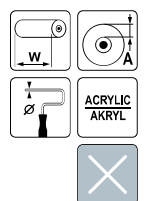

EN Paint roller refill  
 PL Zapas do walka  
 DE Ersatz Farbrolle  
 RU Шубка для валика

CZ Náhradní váleček  
 RO Rezerva trafalet  
 HU Pót festőhenger  
 ES Recambio de rodillo

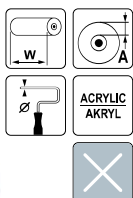

No.	W [mm]	A [mm]	Ø [mm]	
09310	180	20	6	10/40
09311	250	20	6	40

EN Paint roller refill  
 PL Zapas do walka  
 DE Ersatz Farbrolle  
 RU Шубка для валика

CZ Náhradní váleček  
 RO Rezerva trafalet  
 HU Pót festőhenger  
 ES Recambio de rodillo

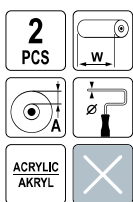

No.	W [mm]	A [mm]	Ø [mm]	
09338	100	9	6	150

EN Paint roller refill  
 PL Zapas do walka  
 DE Ersatz Farbrolle  
 RU Шубка для валика

CZ Náhradní váleček  
 RO Rezerva trafalet  
 HU Pót festőhenger  
 ES Recambio de rodillo

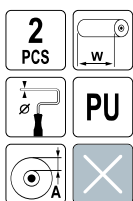

No.	W [mm]	A [mm]	Ø [mm]	
09375	50	35	6	200
09377	100	35	6	90
09378	150	50	6	45

EN Paint grid  
 PL Kratka malarska  
 DE Abstreifgitter  
 RU Решетка малярная  
 CZ Malířská mřížka  
 RO Grătar pt. trafalet  
 HU Festőrács  
 ES Rejilla de pintura



No.	[mm]	
09413	265x285	100

EN Paint roller refill  
 PL Zapas do walka  
 DE Ersatz Farbrolle  
 RU Шубка для валика

CZ Náhradní váleček  
 RO Rezerva trafalet  
 HU Pót festőhenger  
 ES Recambio de rodillo

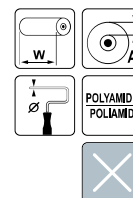

No.	W [mm]	A [mm]	Ø [mm]	
09331	180	6	6	10/50
09332	250	6	8	10/40

EN Paint roller refill  
 PL Zapas do walka  
 DE Ersatz Farbrolle  
 RU Шубка для валика

CZ Náhradní váleček  
 RO Rezerva trafalet  
 HU Pót festőhenger  
 ES Recambio de rodillo

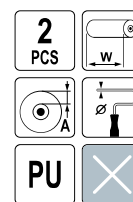

No.	W [mm]	A [mm]	Ø [mm]	
09363	50	35	6	75
09365	100	35	6	80

EN Paint tray  
 PL Kufeta malarska  
 DE Farbwanne  
 RU Ванночка малярная  
 CZ Malířská vanička  
 RO Tavă suport trafalet  
 HU Festéktálca  
 ES Cubeta para rodillo



No.	[mm]	
09406	150x245	75
09408	330x350	50

EN Paint roller with grid  
 PL Walek z kratką  
 DE Farbroller mit Abstreifgitter  
 RU Валик с решёткой  
 CZ Váleček s mřížkou  
 RO Trafalet cu grătar  
 HU Festőhenger ráccsal  
 ES Rodillo con rejilla

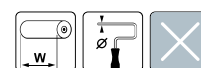

No.	W [mm]	Ø [mm]	
09385	180	6	25

EN Paint roller with tray  
 PL Walek z kuwetą  
 DE Farbroller mit Farbwanne  
 RU Валик с ванночкой  
 CZ Váleček s vaničkou  
 RO Trafalet cu tavă  
 HU Festőhenger és küvettával  
 ES Rodillo y cubeta

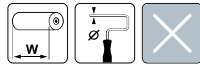

No.	W [mm]	Ø [mm]	☐
09390	180	6	12

EN Roller frame  
 PL Uchwyt do wałka  
 DE Farbröller-Griff  
 RU Ручка для валика

CZ Držák válečku  
 RO Mâner trafalet  
 HU Festőhenger nyél  
 ES Mango de rodillo

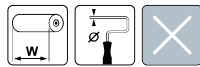

No.	W [mm]	Ø [mm]	☐
09421	50/70	6	90
09422	100	6	90
09425	150	6	150
09427	180	6	110
09429	250	6	110
09430	250	8	80

EN Flat paint brush  
 PL Pędzel angielski profesjonalny  
 DE Professional Flachpinsel  
 RU Профессиональная кисть флейцевая тип Английский  
 CZ Anglický štětec profesionální  
 RO Pensulă englezească profesională  
 HU Profesionális laposecset  
 ES Brocha plana profesional

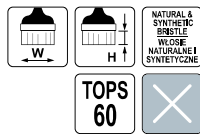

No.	W [mm]	H [mm]	☐
09531	25	51/46	50
09532	36	51/46	50
09533	50	57/52	50
09534	62	57/52	50
09535	75	57/52	50
09536	87	64/59	50
09537	102	64/59	50

EN Paint roller with tray  
 PL Walek z kuwetą  
 DE Farbroller mit Farbwanne  
 RU Валик с ванночкой  
 CZ Váleček s vaničkou  
 RO Trafalet cu tavă  
 HU Festőhenger és küvettával  
 ES Rodillo y cubeta

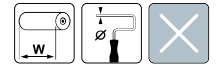

No.	W [mm]	Ø [mm]	☐
09395	50	6	60

EN Flat paint brush  
 PL Pędzel angielski  
 DE Flachpinsel  
 RU Кисть флейцевая тип Английский  
 CZ Štětec anglický  
 RO Pensulă englezească  
 HU Laposecset  
 ES Brocha plana

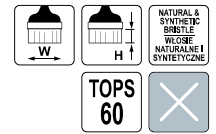

No.	W [mm]	H [mm]	☐
09521	25	44/39	50
09522	36	51/46	50
09523	50	51/46	50
09524	63	51/46	50
09525	76	51/46	50

EN Angled paint brush  
 PL Pędzel kaloryferowy  
 DE Heizkörperpinsel  
 RU Кисть радиаторная  
 CZ Štětec na topná tělesa  
 RO Pensulă pt. calorifere  
 HU Radiátorecset  
 ES Brocha angular de radiadores



No.	W [mm]	H [mm]	☐
09560	25	44/39	50
09561	36	51/46	50
09562	50	51/46	50

EN Round paint brush  
 PL Pędzel okrągły  
 DE Ringpinsel  
 RU Кисть круглая  
 CZ Kulatý štětec  
 RO Pensula rotundă  
 HU Marokécszet  
 ES Brocha redonda



No.	W [mm]	H [mm]	
09581	20	44/39	50
09583	30	51/46	50
09585	40	51/46	50
09587	50	57/52	50
09589	60	57/52	50

EN Paint brush  
 PL Ławkowiec  
 DE Malerbürste  
 RU Кисть-макловица деревянная ручка  
 CZ Natírací kartáč profesionální  
 RO Bidinea profesională  
 HU Profesionális kenőkefe  
 ES Brocha prof.



No.	W [mm]	H [mm]	
09647	170x65	64/58	10
09648	180x75	70/64	10
09649	190x85	76/68	10

EN Paint brushes  
 PL Pędzle malarskie  
 DE Pinselset  
 RU Набор кистей  
 CZ Sada malířských štětců  
 RO Set pensule  
 HU Festőecset készlet  
 ES Brochas de pintar

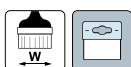

No.	W [mm]	pcs / szt.	
09920	25, 36, 50	3	25/200
09930	36, 50, 63	3	40/160
09950	15, 25, 36, 50, 63	5	25/100

EN Brush for wallpapers  
 PL Pędzel do tapet  
 DE Flächenstreicher  
 RU Кисть-макловица деревянная ручка

CZ Štětec na tapety dřevěný  
 RO Bidinea profi pt. tapet  
 HU Ecset fa tapétákhoz  
 ES Brocha de empapelar madero

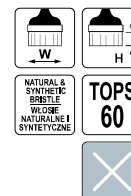

No.	W [mm]	H [mm]	
09636	110x30	51/46	30
09638	130x30	51/46	30
09640	140x40	57/52	30
09642	150x50	64/59	30

EN Paint brush  
 PL Chłapacz PCV  
 DE Deckenbürste  
 RU Кисть-макловица ПВХ  
 CZ Smeták PVC  
 RO Bidinea PVC  
 HU PVC meszelő  
 ES Brocha de PVC



No.	W [mm]	
09651	170x60	30

EN Paint brush  
 PL Ławkowiec PET  
 DE Malerbürste  
 RU Кисть-макловица PET  
 CZ Natírací kartáč  
 RO Bidinea  
 HU Kenőkefe  
 ES Brocha



VOREL

No.	W [mm]	
09655	150x70	12
09650	170x70	12
09656	180x80	10

EN Brush for pitch CZ Kartáč asfaltéřský  
 PL Smołowiec RO Perie pt. asfalt  
 DE Pechstein HU Kátránykenő kefe  
 RU Кисть для смолы ES Brocha para alquitrán



No.	W [mm]	
09653	170	30

EN Sheet for construction works  
 PL Folia ochronna malarska  
 DE Abdeckplane  
 RU Пленка защитная  
 CZ Stavební fólie  
 RO Folie pt. construcții  
 HU Építési fólia  
 ES Lona protectora

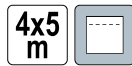

No.	[m]	Thickness / Grubość [μm]	Material / Material	
09462	4x5	5	HDPE	40
09463	4x5	15	LDPE	20

EN Debris bags  
 PL Worki na gruz, mocne  
 DE Müllsäcke stabil  
 RU Мешки для строительного мусора  
 CZ Pytle na suť  
 RO Saci pt. demolari  
 HU Síttes zsák  
 ES Bolsas para escombros



No.	Capacity / Pojemność [l]	Thickness / Grubość [μm]	pcs / szt.	
09475	80	142	10	10
09476	80	142	3	10
09477	120	142	10	10
09478	120	142	3	10

EN Waste bags for styrofoam CZ Pytle na polystyren  
 PL Worki na styropian RO Saci gunoi  
 DE Styropor Entsorgungssäcke HU Szemeteszsák  
 RU Пакеты для мусора строительные материалы ES Sacos de poliestireno

No.	Capacity / Pojemność [l]	Thickness / Grubość [μm]	pcs / szt.	
09472	240	40	10	10

EN Magnetic paint brush holder  
 PL Uchwyt magnetyczny do pędzli  
 DE Magnethalter für Pinsel  
 RU Магнитный патрон для кистей  
 CZ Magnetický držák štětů  
 RO Suport magnetic pt. pensule zugravit  
 HU Mágneses ecsettartó  
 ES Soporte magnético para pinceles

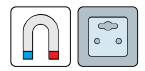

No.	L [mm]	
09590	90	24/96

EN Sheet for construction works  
 PL Folia budowlana mocna  
 DE Abdeckplane  
 RU Пленка защитная строительная повышенной прочности  
 CZ Stavební fólie  
 RO Folie pt. construcții  
 HU Építési fólia  
 ES Lona protectora



No.	[m]	Thickness / Grubość [μm]	
09457	4x5	20	15
09459	4x5	30	10

EN Construction waste bags  
 PL Worki na odpady budowlane  
 DE Müllsäcke  
 RU Мешки для строительного мусора  
 CZ Pytle na stavební odpad  
 RO Saci gunoi pt. santier  
 HU Zsák építési törmelékhez  
 ES Bolsas para desperdicios de construcción



No.	Capacity / Pojemność [l]	Thickness / Grubość [μm]	pcs / szt.	
09470	80	40	10	30
09471	120	60	15	10



EN Self adhesive paper tape  
 PL Taśma papierowa samoprzylepna  
 DE Papierband selbstklebend  
 RU Лента малярная бумажная

CZ Páska papírová samolepící  
 RO Banda adezivă hartie  
 HU Öntapadó papírszalag  
 ES Cinta de papel autoadhesiva

25m 50m



No.	W [mm]	L [m]	<input type="checkbox"/>
75270	19	25	12/48
75271	25	25	9/36
75272	30	25	10/40
75273	38	25	6/24
75274	48	25	6/24
75285	25	50	9/36
75286	30	50	10/40
75287	38	50	6/24
75288	48	50	6/24

EN Plastering tape  
 PL Taśma tynkarska elewacyjna  
 DE Putzband  
 RU Штукатурные лента  
 CZ Fasádní omítková páska  
 RO Banda mascare pt. tencuieli  
 HU Homlokzati festő szalag  
 ES Cinta de enlucido de fachada

20m 50m



No.	W [mm]	L [m]	<input type="checkbox"/>
75130	38	20	24
75131	48	20	24
75132	38	50	28
75133	48	50	24

EN Packing tape, brown  
 PL Taśma pakowa brązowa  
 DE Verpackungsband aus PP, braun  
 RU Упаковочная клейкая лента  
 CZ Balící páska PP hnědá  
 RO Bandă ambalare PP maro  
 HU PP barna ragasztószalag  
 ES Cinta de embalaje marrón

OPP



No.	W [mm]	L [m]	<input type="checkbox"/>
75301	48	40	36
75302	48	66	36

EN Packing tape  
 PL Taśma pakowa  
 DE Band  
 RU Упаковочная клейкая лента  
 CZ Balící páska  
 RO Banda scotch  
 HU Csomagolószalag  
 ES Cinta de embalaje

No.	W [mm]	L [m]	<input type="checkbox"/>
75300	48	45	12/36

EN Blue masking tape  
 PL Taśma maskująca, niebieska  
 DE Malerei blau Tape  
 RU Малярна стрічка

CZ Maskovací páska  
 RO Bandă de mascare  
 HU Fedőszalag  
 ES Cinta adhesiva azul

25m 50m



No.	W [mm]	L [m]	<input type="checkbox"/>
75120	30	25	40
75121	38	25	24
75122	48	25	24
75123	30	50	40
75124	38	50	24
75125	48	50	24

EN „DUCT” tape  
 PL Taśma tekstylna „DUCT”  
 DE Textilband „DUCT”  
 RU Лента армированная на тканевой основе  
 CZ Textilní páska „DUCT”  
 RO Bandă textilă „DUCT”  
 HU „DUCT” textil szalag  
 ES Cinta textil “DUCT”

DUCT



No.	W [mm]	L [m]	<input type="checkbox"/>
75238	48	10	24
75239	38	50	28
75240	48	50	24

EN Packing tape, transparent  
 PL Taśma pakowa przezroczysta  
 DE Verpackungsband aus PP, durchsichtig  
 RU Упаковочная клейкая лента

CZ Balící páska PP průhledná  
 RO Bandă ambalare PP transparentă  
 HU Átlátszó ragasztószalag  
 ES Cinta de embalaje transparente

OPP



No.	W [mm]	L [m]	<input type="checkbox"/>
75303	48	40	36
75304	48	66	36



EN Bucket  
PL Wiadro  
DE Eimer  
RU Ведро  
CZ Vědro  
RO Galeată  
HU Vödör  
ES Cubo



No.	Capacity / Pojemność [l]	
06388	10	900
06390	12	680
06383	13	800
06393	16	450
06392	20	390
06384	21	400

EN Painting bucket  
PL Wiadro malarskie  
DE Malereimer  
RU Ведро малярное  
CZ Vědro malářské  
RO Galeată pt. vopsea  
HU Festővödör  
ES Cubo para pintar



No.	Capacity / Pojemność [l]	Dimensions / Wymiary [mm]	
09400	14	360x250x225	315

EN Tub for mass mixing  
PL Kastrą budowlaną  
DE Mörtelkasten  
RU Кювета для перемешивания раствора

CZ Stavební vědro  
RO Vas plastic constructii  
HU Kőműves vödör  
ES Caba de obra



No.	Capacity / Pojemność [l]	
06394	40	210
06395	60	210
06396	90	120

EN Bucket  
PL Wiadro  
DE Eimer  
RU Ведро  
CZ Vědro  
RO Galeată  
HU Vödör  
ES Cubo



No.	Capacity / Pojemność [l]	
06391	12	720
06381	16	420
06382	20	500

EN Tub for mass mixing  
PL Kastrą budowlaną  
DE Mörtelkasten  
RU Таз строительный круглый  
CZ Stavební vědro  
RO Vas plastic constructii  
HU Kőműves vödör  
ES Caba de obra



No.	Capacity / Pojemność [l]	
06397	40	110
06398	65	100
06399	90	160

EN Construction and garden bucket  
PL Kubel budowlano-ogrodowy  
DE Bau- und Gartenbehälter  
RU Строительный и садовый контейнер  
CZ Stavební a zahradní nádoba  
RO Galeată pt. gradina si constructii  
HU Építőipari és kerti vödör  
ES Espuerta para obra y jardín



No.	Capacity / Pojemność [l]	
06338	40	150

EN Suction lifter  
 PL Uchwyt-przyssawka do szyb  
 DE Glas-Gummissauger  
 RU Держатель-присоска для стекол  
 CZ Podtlakový držák na sklo  
 RO Ventuza  
 HU Szélvédő kiemelő  
 ES Elevador tipo ventosa



No.	Ø [mm]	Max. lifting capacity / Maks. udźwig [kg]	
05300	115	40	48

EN Suction lifter  
 PL Uchwyt-przyssawka do szyb  
 DE Glas-Gummissauger  
 RU Держатель-присоска для стекол тройная  
 CZ Podtlakový držák na sklo  
 RO Ventuze  
 HU Szélvédő kiemelő  
 ES Elevador tipo ventosa



No.	Ø [mm]	Max. lifting capacity / Maks. udźwig [kg]	
05302	115	100	12

EN Suction lifter  
 PL Uchwyt-przyssawka do szyb  
 DE Glas-Gummissauger  
 RU Держатель-присоска для стекол двойная  
 CZ Podtlakový držák na sklo  
 RO Ventuze  
 HU Szélvédő kiemelő  
 ES Elevador tipo ventosa

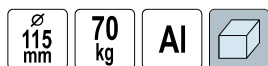

No.	Ø [mm]	Max. lifting capacity / Maks. udźwig [kg]	
05312	115	70	10

EN Pump suction cup  
 PL Uchwyt-przyssawka  
 DE Saugheber  
 RU Держатель-присоска  
 CZ Vakuový držák  
 RO Ventuza cu pompa  
 HU Vákuumos tapadókorong  
 ES Ventosa bomba de vacío



No.	Ø [mm]	Max. lifting capacity / Maks. udźwig [kg]	
05325	204	100	10

EN Suction lifter  
 PL Uchwyt-przyssawka do szyb  
 DE Glas-Gummissauger  
 RU Держатель-присоска для стекол двойная  
 CZ Podtlakový držák na sklo  
 RO Ventuze  
 HU Szélvédő kiemelő  
 ES Elevador tipo ventosa

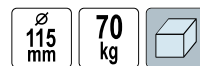

No.	Ø [mm]	Max. lifting capacity / Maks. udźwig [kg]	
05301	115	70	24

EN Suction lifter  
 PL Uchwyt-przyssawka do szyb  
 DE Glas-Gummissauger  
 RU Держатель-присоска для стекол  
 CZ Podtlakový držák na sklo  
 RO Ventuza  
 HU Szélvédő kiemelő  
 ES Elevador tipo ventosa

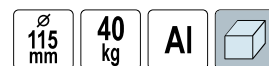

No.	Ø [mm]	Max. lifting capacity / Maks. udźwig [kg]	
05311	115	40	50

EN Pump suction cup  
 PL Uchwyt-przyssawka  
 DE Saugheber  
 RU Держатель-присоска  
 CZ Vakuový držák  
 RO Ventuza cu pompa  
 HU Vákuumos tapadókorong  
 ES Ventosa bomba de vacío

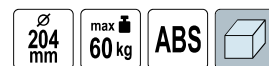

No.	Ø [mm]	Max. lifting capacity / Maks. udźwig [kg]	
05319	204	60	10



EN Hook  
 PL Hak budowlany  
 DE Mauerhaken  
 RU Крюк строительный  
 CZ Stavební hák  
 RO Cârlig de construcții  
 HU Építőipari horog  
 ES Gancho de obra



**JUCO**

No.		
34950		25

EN Deep hole pencil with leads  
 PL Ołówek do głębokich otworów z rysikami  
 DE Tieflochmarker mit Ersatzminen  
 RU Карандаш для глубоких отверстий со сменными стержнями  
 CZ Tužka do hlubokých otvorů s náhradními náplněmi  
 RO Marker pt. orificii adânci  
 HU Mélylyuk jelölő hegyekkel  
 ES Lápiz para orificios profundos con puntas de trazar

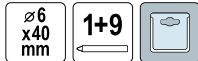

**VOREL**

No.		
09200		10/100

EN Wax refills for automatic pencil  
 PL Zestaw rysików woskowych do markera  
 DE Ersatzwachsmineinsatz für Marker  
 RU Набор восковых стержней для маркера  
 CZ Voskové náplně do automatické tužky  
 RO Rezervă de ceară pt. creion automat  
 HU Tartalék hegy szett automata ceruzához  
 ES Conjunto de rellenos de cera para marcador

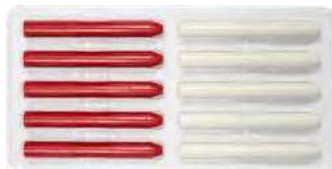

**VOREL**

No.	For / Dla	pcs / szt.	
09207	09204	10	10/100

EN Wire tying twister hook  
 PL Klucz do wiązania drutu zbrojeniowego  
 DE Rödeldraht-Drillkurbel  
 RU Крючок для вязки арматуры  
 CZ Radlovačka  
 RO Dispozitiv pt. legat fier beton  
 HU Huzalsodró  
 ES Gancho para amarrar alambre



**VOREL**

No.	L [mm]	
49830	240	20

EN Carpenter's pencil  
 PL Ołówek stolarski  
 DE Zimmermannsbleistifte  
 RU Карандаш столярный  
 CZ Tesařská tužka  
 RO Creion de tâmplărie  
 HU Asztalos ceruza  
 ES Lápiz de carpintero



No.	L [mm]	pcs / szt.	
09180	180	12	60/240

EN Automatic wax pencil  
 PL Marker woskowy automatyczny  
 DE Automatischer Wachsmarker  
 RU Маркер восковой автоматический  
 CZ Automatická vosková tužka  
 RO Creion automat cu ceară  
 HU Automata viasz ceruza  
 ES Marcador de cera automático



**VOREL**

No.		
09204		10/100

EN Carpenter's pencil sharpener  
 PL Temperówka do ołówek stolarskich  
 DE Zimmermann-Bleistift-Anspitzer  
 RU Тоцилка для столярных карандашей  
 CZ Ořezávkto na tesařskou tužku  
 RO Ascuzitoare pt. creioane de tamplarie  
 HU Ceruzahegyező  
 ES Sacapuntas para lápiz de carpintero



**VOREL**

No.		
09190		40/240

EN Sheet metal bending machine  
 PL Giętarka do blach  
 DE Blechbiegemaschine  
 RU Гибочный станок для листового металла  
 CZ Ohýbačka plechu  
 RO Mașină de îndoit tablă  
 HU Lemezhajlító gép  
 ES Plegadora de chapa



**VOREL**

No.	Working width / Szerokość robocza [mm]	
49900	460	1

EN Rebar bender  
 PL Klucz do gięcia prętów  
 DE Betonstahl-Bieger  
 RU Ручной ключ для гибки арматуры  
 CZ Klíč pro ohýbání tyčí  
 RO Dispozitiv indoit fier beton  
 HU Kézi betonacél hajlító  
 ES Dobladora manual de barras

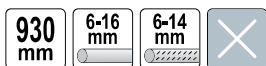

**VOREL**

No.	L [mm]	
49810	930	4

EN Rebar bender  
 PL Giętarka do prętów  
 DE Betonstahl-Bieger  
 RU Станок для гибки арматуры

CZ Ohýbačka tyčí  
 RO Dispozitiv indoit sârmă  
 HU Betonvas hajlító  
 ES Dobladora de barras



**VOREL**

No.	Ø [mm]	Dimensions / Wymiary [mm]	
49800	6-8	16x12x5	4
49801	10-12	25x16x6	4
49802	14-16	25x16x6	2

EN Rod extractor  
 PL Wyciągacz do prętów  
 DE Stangenauszieher  
 RU Ручной вытягиватель прутка  
 CZ Vytahovač tyčí  
 RO Extractor tije  
 HU Rúdkihúzó  
 ES Extractor de varillas



**VOREL**

No.	Rod diameter / Średnica pręta [mm]	
35007	8-28	6

EN Rebar bender  
 PL Giętarka do prętów  
 DE Betonstahl-Bieger  
 RU Станок для гибки арматуры

CZ Ohýbačka tyčí  
 RO Dispozitiv indoit sârmă  
 HU Betonvas hajlító  
 ES Dobladora de barras

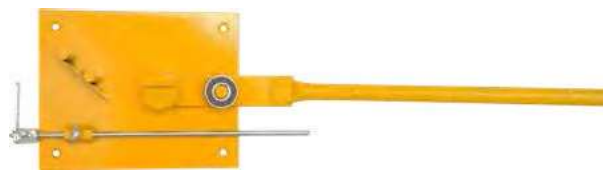

**VOREL**

No.	Ø [mm]	Dimensions / Wymiary [mm]	Bearing / Łożysko [mm]	
49805	6-8	17x17x5	35x15	2
49806	10-14	25x20x5	45x20	2

EN Hand tamper  
 PL Ubijak brukarski  
 DE Pflasterstampfer  
 RU Ручная трамбовка для уплотнения грунта  
 CZ Pěchovadlo na pokládku dlažby  
 RO Tamper de mână  
 HU Kézi döngölő  
 ES Compactador manual de adoquines



**VOREL**

No.	
35000	1

EN Longitudinal clamp  
 PL Chwytnak brukarski wzdluzny regulowany  
 DE Bordstein-Verlegezange  
 RU Захват-клещи для бордюра продольные

CZ Kleště na obrubníky podélné  
 RO Cleste pt. borduri  
 HU Hosszirányúszegélykő emelő fogó  
 ES Pinza de colocación de rebordes mecánica



**VOREL**

No.	Grip range / Zakres chwytu [mm]	
35010	980-1170	2

EN Lateral clamp  
PL Chwytnak poprzeczny, podwójny  
DE Bordsteinverlegezange  
RU Захват-клепсе для бордюра поперечные

CZ Kleště na obrubníky příčné  
RO Cleste pt. borduri  
HU Keresztirányúszegegykő emelő fogó  
ES Pavimentación pinza doble



**VOREL**

No.	Grip range / Zakres chwytu [mm]	
35012	90-360	2

EN Grapple for cobblestones  
PL Chwytnak zbiorczy do kostki brukowej  
DE Pflastersteinträger  
RU Захват ручной для переноса бордюрного камня и блоков

CZ Nosič na cihly  
RO Cleste pt. borduri  
HU Emelő fogó  
ES Pinza para bordillos longitudinal

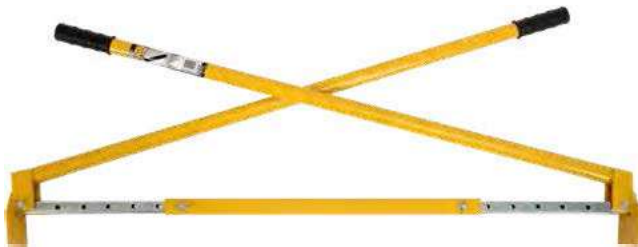

**VOREL**

No.	Grip range / Zakres chwytu [mm]	
35015	700-1100	4

EN Brick tongs  
PL Chwytnak do podnoszenia płyt lub cegieł  
DE Greifer zum Heben von Platten oder Ziegeln  
RU Захват для подъема плит или кирпича  
CZ Nástroj pro přenášení desek a cihel  
RO Cleste caramida  
HU Csempé- és téglafogó  
ES Pinzas para transportar placas o ladrillos

410-680  
mm



**VOREL**

No.	Grip range / Zakres chwytu [mm]	
35018	410-680	12

EN Rubber for lateral clamp  
PL Zapasowe końcówki do chwytaka  
DE Ersatzgummi für Bordsteinverlegezange  
RU Зпасныя наконечнікі  
CZ Náhradní gumový úchyt  
RO Mânere de cauciuc de rezervă  
HU Gumi alkatrészek  
ES Punta de repuesto

4  
PCS



**VOREL**

No.	For / Dla	pcs / szt.	
35013	35012	4	10

EN Paving slab lifter  
PL Chwytnak brukarski wysoki  
DE Hoher Pflastergreifer  
RU Захват для бордюра  
CZ Držák na dlažební kostky  
RO Dispozitiv pt. ridicat dale de pavaj  
HU Magas térkökiemelő  
ES Pinza para adoquines alta



**VOREL**

No.	Grip range / Zakres chwytu [mm]	
35014	220-500	5

EN Slabgrabber  
PL Chwytnak brukarski jednoręczny regulowany  
DE Pflasterstein- und Klinker-Träger  
RU Захваты для тротуарной плитки кирпича, блоков  
CZ Kleště na dlažbu a cihly  
RO Cleste pt. caramizi  
HU Burkolólap fogó  
ES Pinza de colocación de losas



**VOREL**

No.	Grip range / Zakres chwytu [mm]	
35017	255-400	4

EN Paver puller  
PL Imak brukarski regulowany  
DE Steinszieher-Steinheber  
RU Захват для камня

CZ Kleště na vytahování dlažby  
RO Ridicator de pavele  
HU Térkökiemelő szerszám  
ES Extractor de adoquines



**VOREL**

No.	Grip range / Zakres chwytu [mm]	
35020	80-275	4

EN Blades for paver puller  
 PL Zapasowe ostrza do imaka  
 DE Ersatzklingen für Steinzieher-Steinheber  
 RU Запасные лезвия  
 CZ Náhradní čepele  
 RO Tartalék penge  
 HU Lame de rezerva  
 ES Cuchillas de repuesto



No.	For / Dla	pcs / szt.	
35021	35020	2	20

EN Blade for paver adjuster  
 PL Ostrze do łomu brukarskiego  
 DE Ersatzklingen für Richtleisten  
 RU Запасные лезвия  
 CZ Náhradní čepele  
 RO Lame de rezerva  
 HU Tartalék penge  
 ES Cuchillas de repuesto



No.	For / Dla	
35026	35025	20

11

EN Paver lifter  
 PL Zgarniacz brukarski do podsypki  
 DE Plan-Abzieher für Pflasterbau  
 RU Правило для выравнивания основания под тротуарную плитку  
 CZ Stahovací lišta  
 RO Sistem de nivelare manuala  
 HU Ágyazat lehűző rendszer  
 ES Sistema de enrasado manual

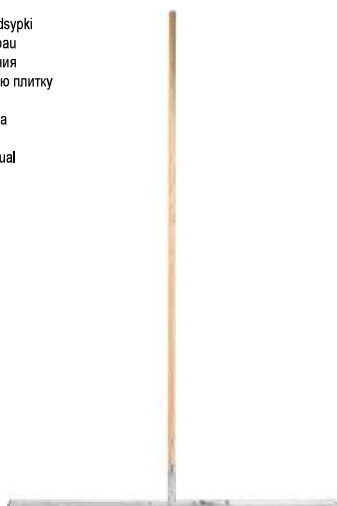

No.	L [cm]	
35033	75	1
35032	120	1

EN Garden paving stone mould  
 PL Forma do kostki brukowej  
 DE Pflasterform  
 RU Форма для брусчатки  
 CZ Forma pro dlažební kostky  
 RO Matrita pt. pavaje  
 HU Térkö-minta sablon  
 ES Plantilla para adoquines



No.	Dimensions / Wymiary [mm]	
35060	430x425x40	10

EN Paver adjuster  
 PL Łom wyważak brukarski  
 DE Richtleisen für Pflasterbau  
 RU Лом с упором для демонтажа тротуарной плитки  
 CZ Tuč pro opravu dlažby  
 RO Bara de aliniere pavaj  
 HU Térkö-szortelő  
 ES Barra alineadora de adoquines



No.	
35025	4

EN Paver lifter  
 PL Zgarniacz brukarski do podsypki  
 DE Plan-Abzieher für Pflasterbau  
 RU Правило для выравнивания основания под тротуарную плитку  
 CZ Stahovací lišta  
 RO Sistem de nivelare manuala  
 HU Ágyazat lehűző rendszer  
 ES Sistema de enrasado manual

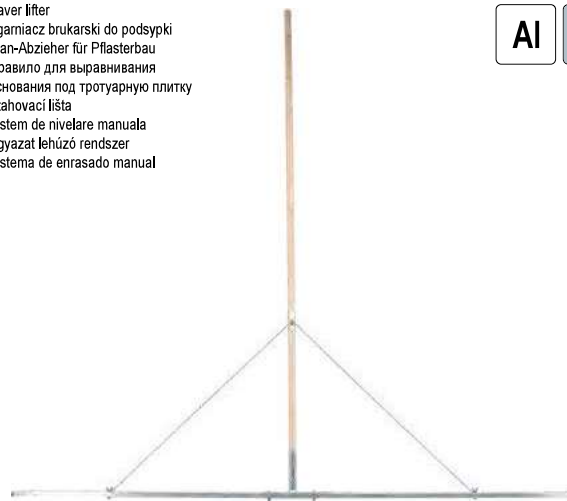

No.	L [cm]	
35031	150	1
35030	200	1

EN Garden paving stone mould  
 PL Forma do kostki brukowej  
 DE Pflasterform  
 RU Форма для брусчатки

CZ Forma pro dlažební kostky  
 RO Matrita pt. pavaje  
 HU Térkö-minta sablon  
 ES Plantilla para adoquines

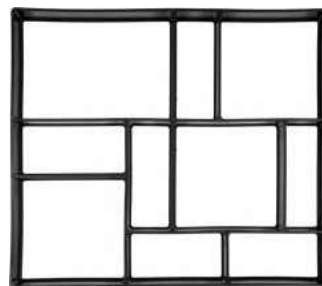

No.	Dimensions / Wymiary [mm]	
35061	450x400x40	10

EN Garden paving stone mould  
 PL Forma do kostki brukowej  
 DE Pflasterform  
 RU Форма для брусчатки  
 CZ Forma pro dlažební kostky  
 RO Matrita pt. pavaje  
 HU Térkö-minta sablon  
 ES Plantilla para adoquines

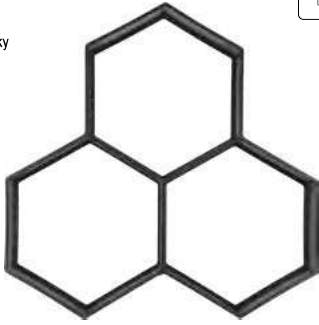

No.	Dimensions / Wymiary [mm]	
35062	360x360x40	10

EN Garden paving stone mould  
 PL Forma do kostki brukowej  
 DE Pflasterform  
 RU Форма для брусчатки  
 CZ Forma pro dlažební kostky  
 RO Matrita pt. pavaje  
 HU Térkö-minta sablon  
 ES Plantilla para adoquines



No.	Dimensions / Wymiary [mm]	
35064	400x400x40	10

EN Garden paving stone mould  
 PL Forma do kostki brukowej  
 DE Pflasterform  
 RU Форма для брусчатки  
 CZ Forma pro dlažební kostky  
 RO Matrita pt. pavaje  
 HU Térkö-minta sablon  
 ES Plantilla para adoquines

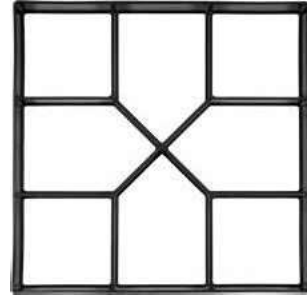

No.	Dimensions / Wymiary [mm]	
35063	400x400x40	10

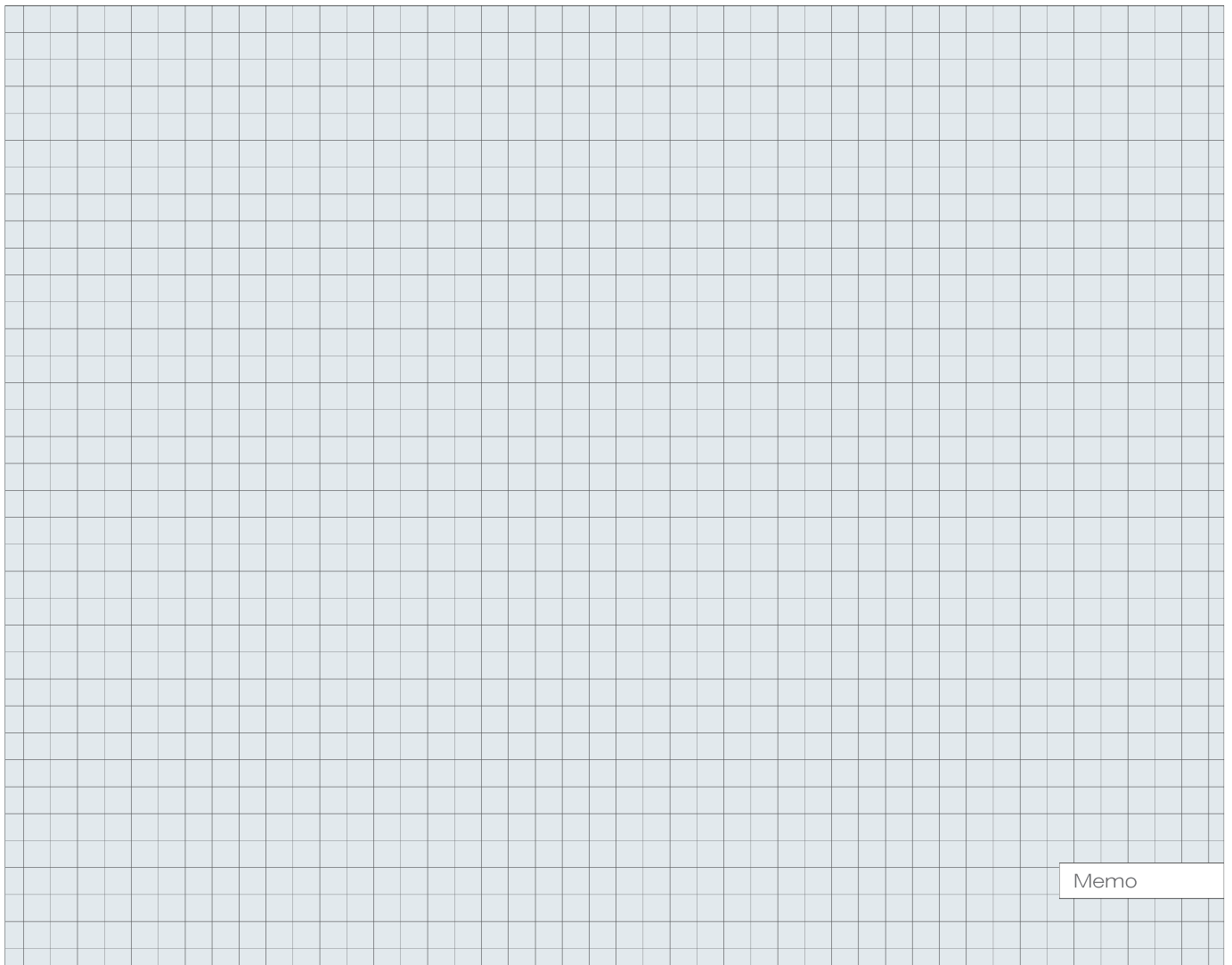
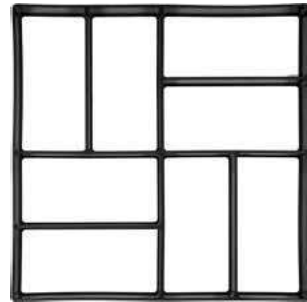

Memo